



CRPuO



MPL



uOttawa



IASBS

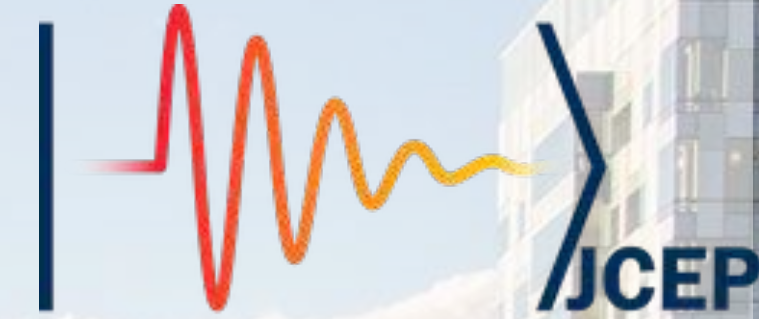

JCEP

From Structured Photons to Structured Electrons

PRÉSENTÉ PAR : EBRAHIM KARIMI | PRESENTED BY: EBRAHIM KARIMI

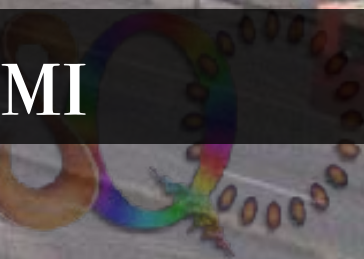

Elementary particles

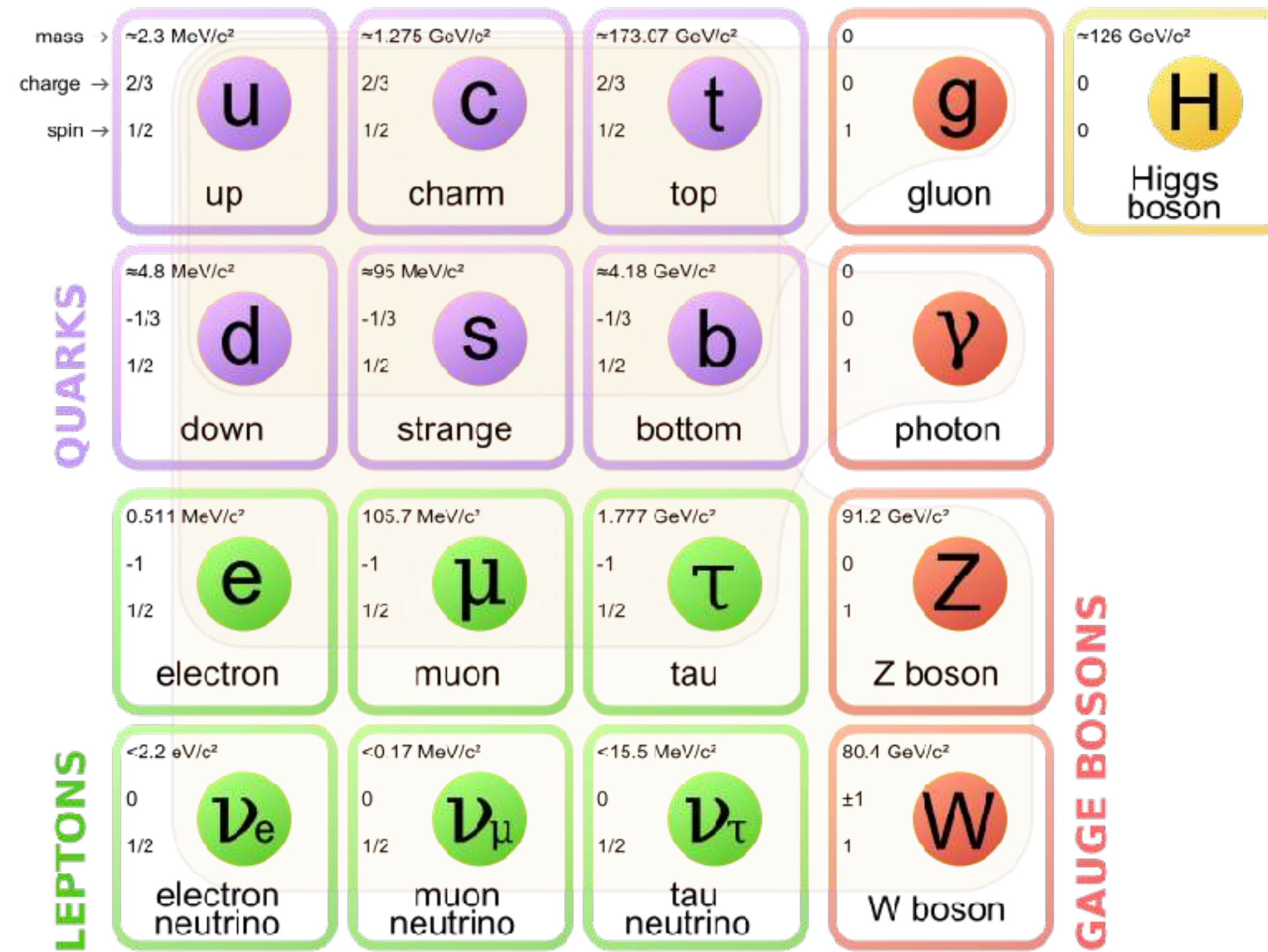

Elementary particles

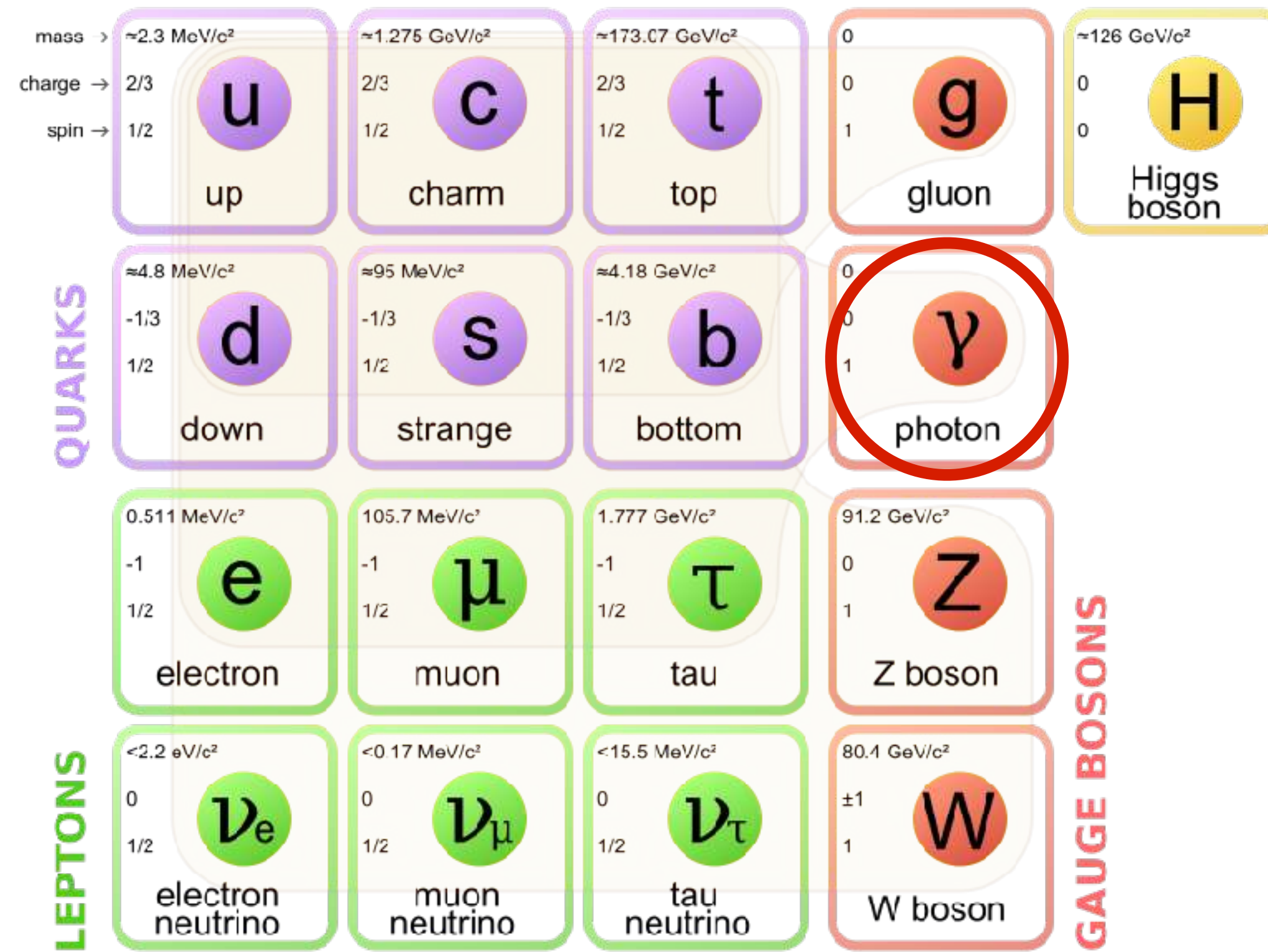

» An elementary particle

$$m_\gamma = 0 \text{ kg}$$

$$q_\gamma = 0 \text{ C}$$

$$|S| = 1$$



Elementary particles

	mass →	charge →	spin →					
QUARKS	≈2.3 MeV/c ²	2/3	1/2	u up	≈1.275 GeV/c ²	2/3	1/2	c charm
					≈173.07 GeV/c ²	2/3	1/2	t top
					0	0	1	g gluon
								≈126 GeV/c ²
								H Higgs boson
	≈4.8 MeV/c ²	-1/3	1/2	d down	≈95 MeV/c ²	-1/3	1/2	s strange
					≈4.18 GeV/c ²	-1/3	1/2	b bottom
					0	0	1	γ photon
LEPTONS	0.511 MeV/c ²	-1	1/2	e electron	105.7 MeV/c ²	-1	1/2	μ muon
					1.777 GeV/c ²	-1	1/2	τ tau
					91.2 GeV/c ²	0	1	Z Z boson
	<2.2 eV/c ²	0	1/2	ν_e electron neutrino	<0.17 MeV/c ²	0	1/2	ν_μ muon neutrino
					<15.5 MeV/c ²	0	1/2	ν_τ tau neutrino
					80.4 GeV/c ²	±1	1	W W boson

» An elementary particle
 $m_e = 9.10 \times 10^{-31} \text{ kg}$
 $e = -1.6 \times 10^{-19} \text{ C}$
 $|S| = \frac{1}{2}$

» An elementary particle
 $m_\gamma = 0 \text{ kg}$
 $q_\gamma = 0 \text{ C}$
 $|S| = 1$



Elementary particles

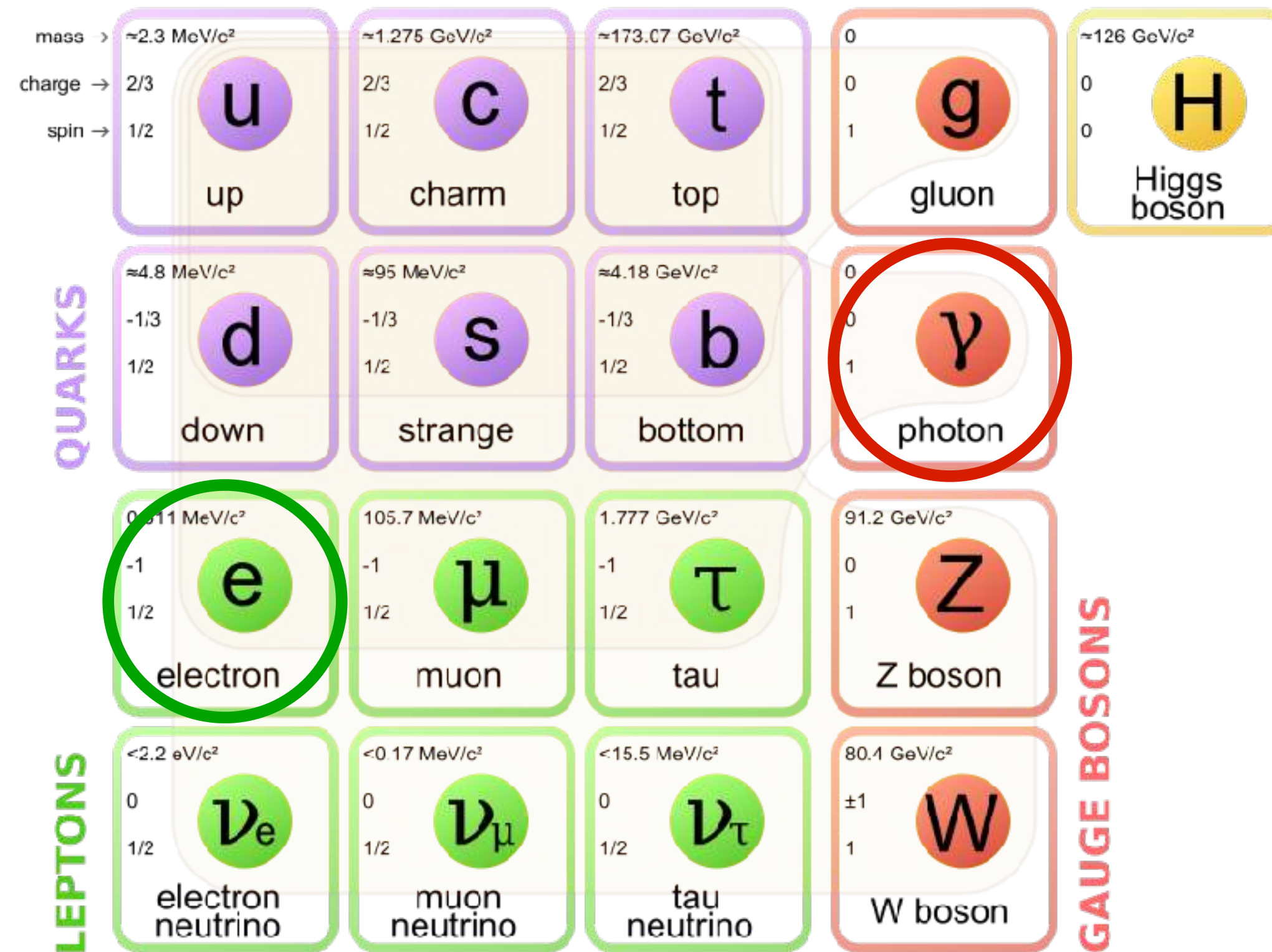

» An elementary particle
 $m_e = 9.10 \times 10^{-31} \text{ kg}$
 $e = -1.6 \times 10^{-19} \text{ C}$
 $|S| = \frac{1}{2}$

» An elementary particle
 $m_\gamma = 0 \text{ kg}$
 $q_\gamma = 0 \text{ C}$
 $|S| = 1$

- Electron
- Proton
- Photon
- Neutron
- Boson
- ...
- ...
- ...
- Person



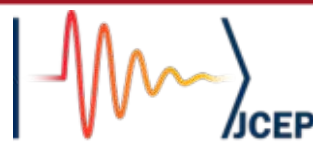

Light: Maxwell's Equations

$$\nabla \cdot \mathbf{D} = \rho$$

$$\nabla \cdot \mathbf{B} = 0$$

$$\nabla \times \mathbf{E} = -\frac{\partial \mathbf{B}}{\partial t}$$

$$\nabla \times \mathbf{H} = \mathbf{J} + \frac{\partial \mathbf{D}}{\partial t}$$



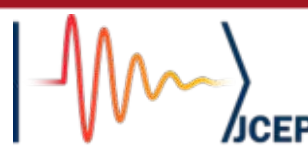

Light: Maxwell's Equations

$$\nabla \cdot \mathbf{D} = \rho$$

$$\alpha^\mu \partial_\mu \mathcal{F}^i = 0$$

$$\partial_i \mathcal{F}^i = 0$$

$$\nabla \times \mathbf{H} = \mathbf{J} + \frac{\partial \mathbf{D}}{\partial t}$$



Light: Degrees of Freedom

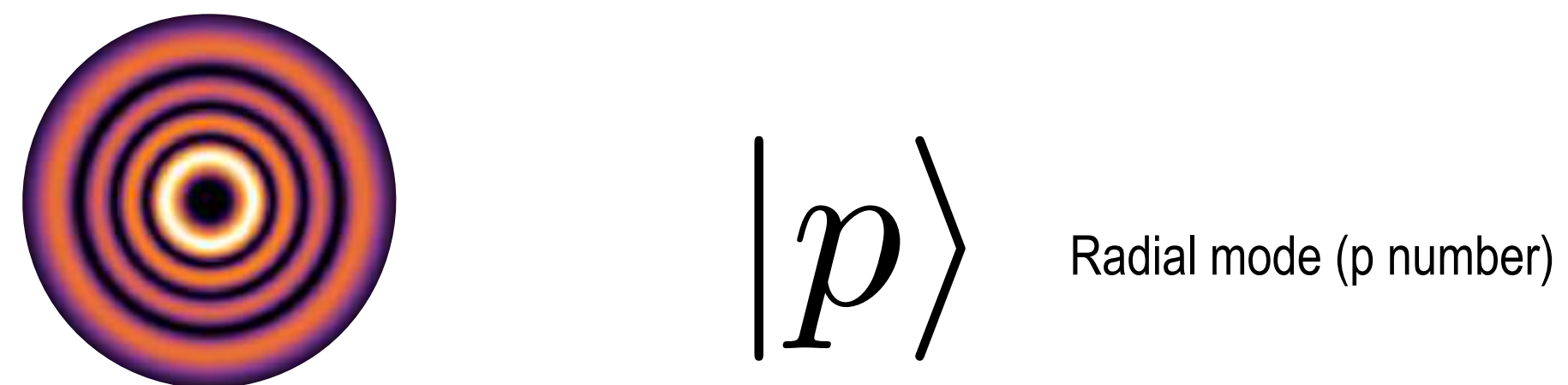
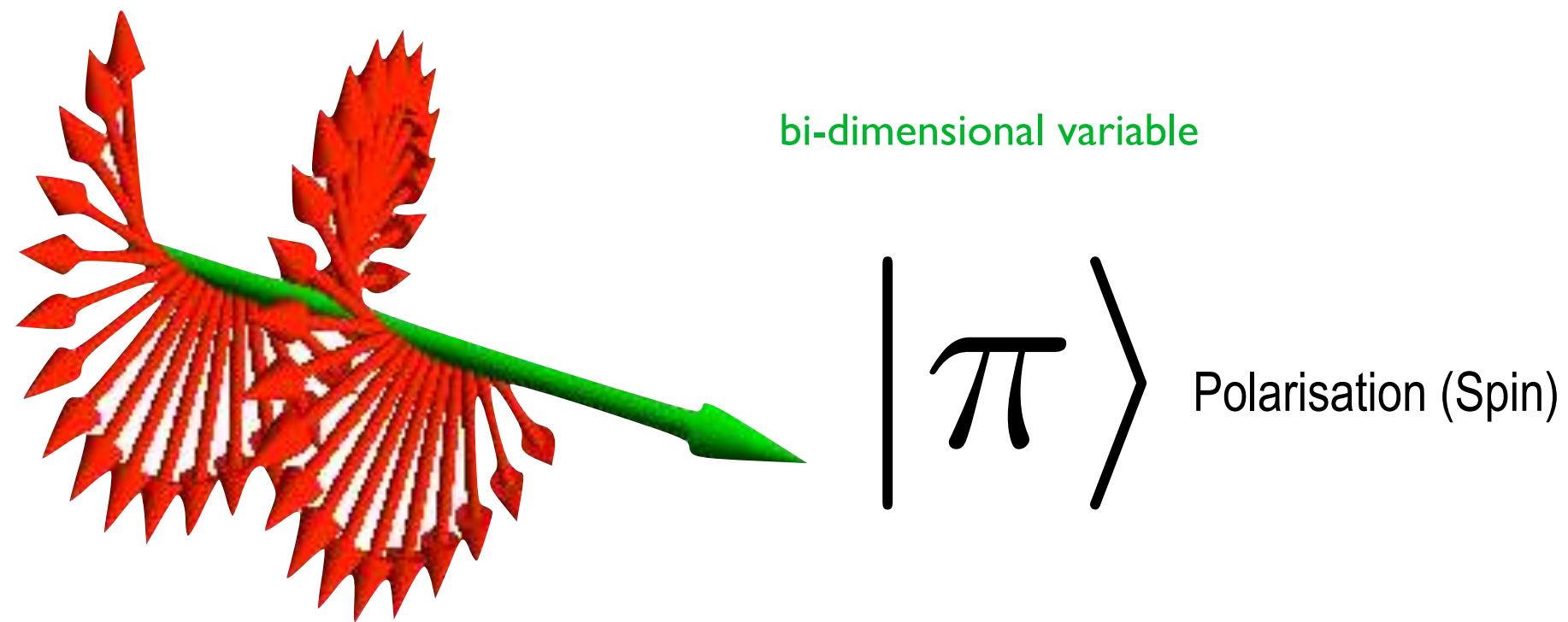

infinite dimension (discrete)

Linear momentum (k-vector)

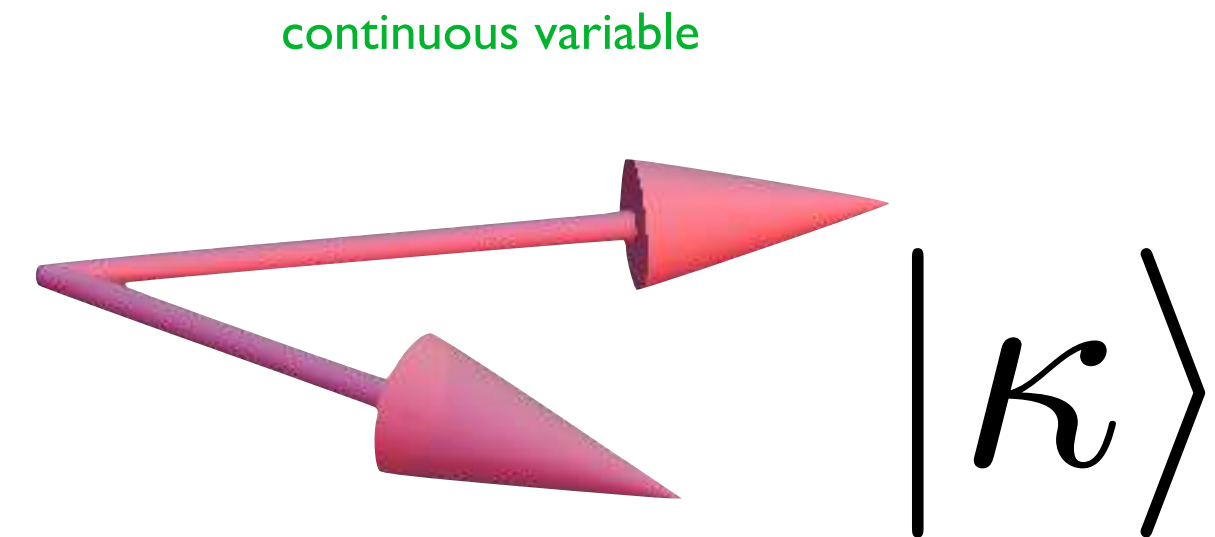

Orbital angular momentum (OAM)

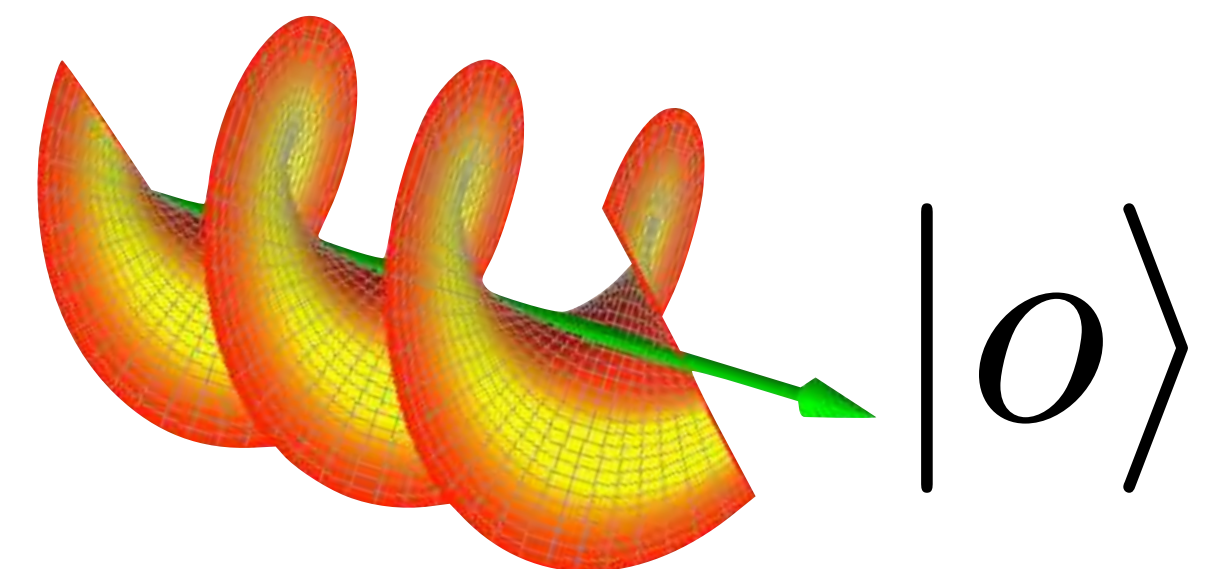

E. K. & E Santamato, *Optics Letters* **37**, 2484 (2012).

E. K., et al., *Phys. Rev. A* **89**, 063813 (2014).



Structured Photons

$$|\psi\rangle = \sum_{\omega, \sigma, n, p, \ell} c_{n,p,\ell}^{\omega, \sigma} |\omega, \sigma, n, p, \ell\rangle$$

$\omega \in \mathbb{R}$

$\sigma \in \{-1, +1\}$

$n \in \mathbb{Z}^+$

$p \in \mathbb{Z}^+$

$\ell \in \mathbb{Z}$

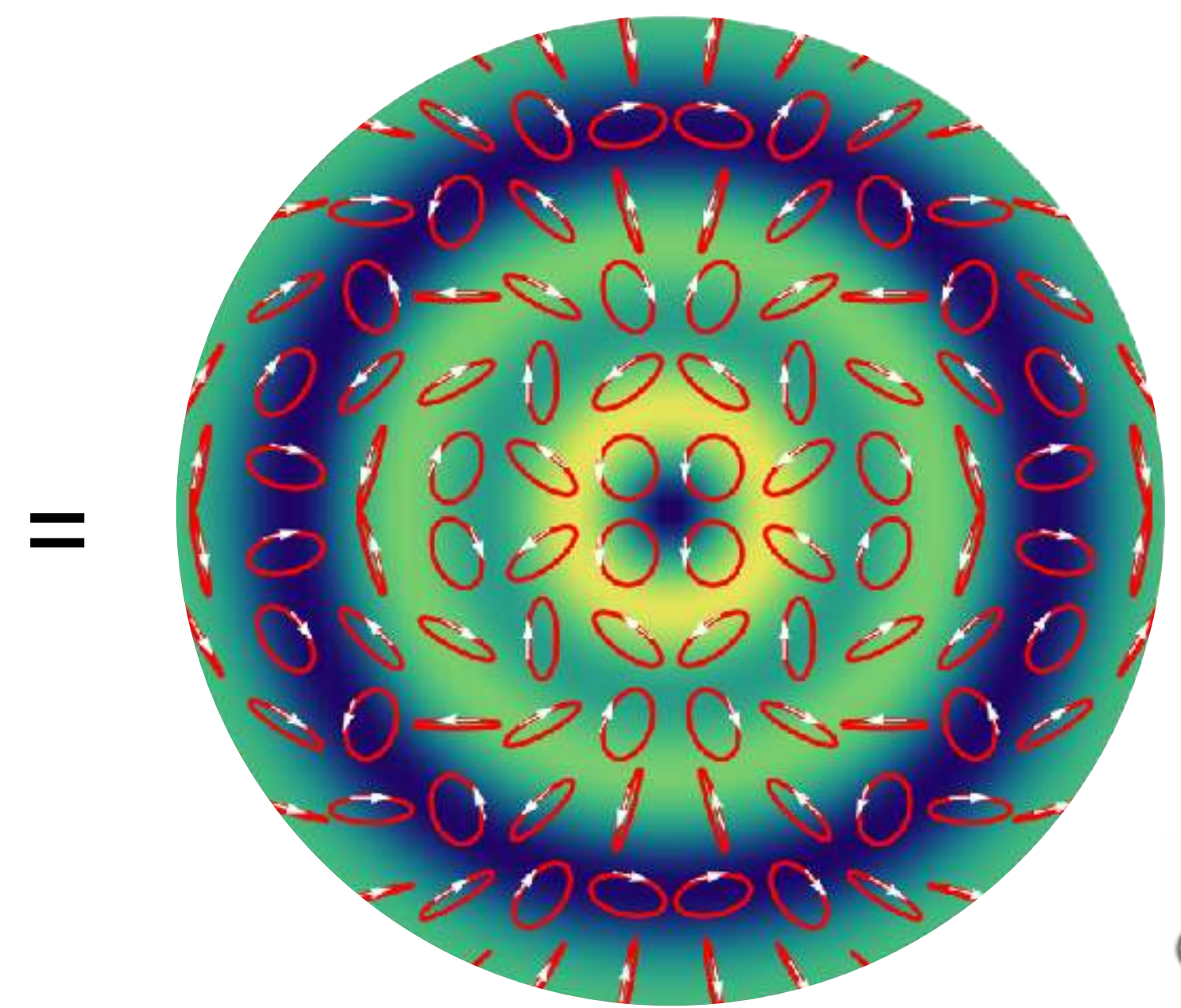
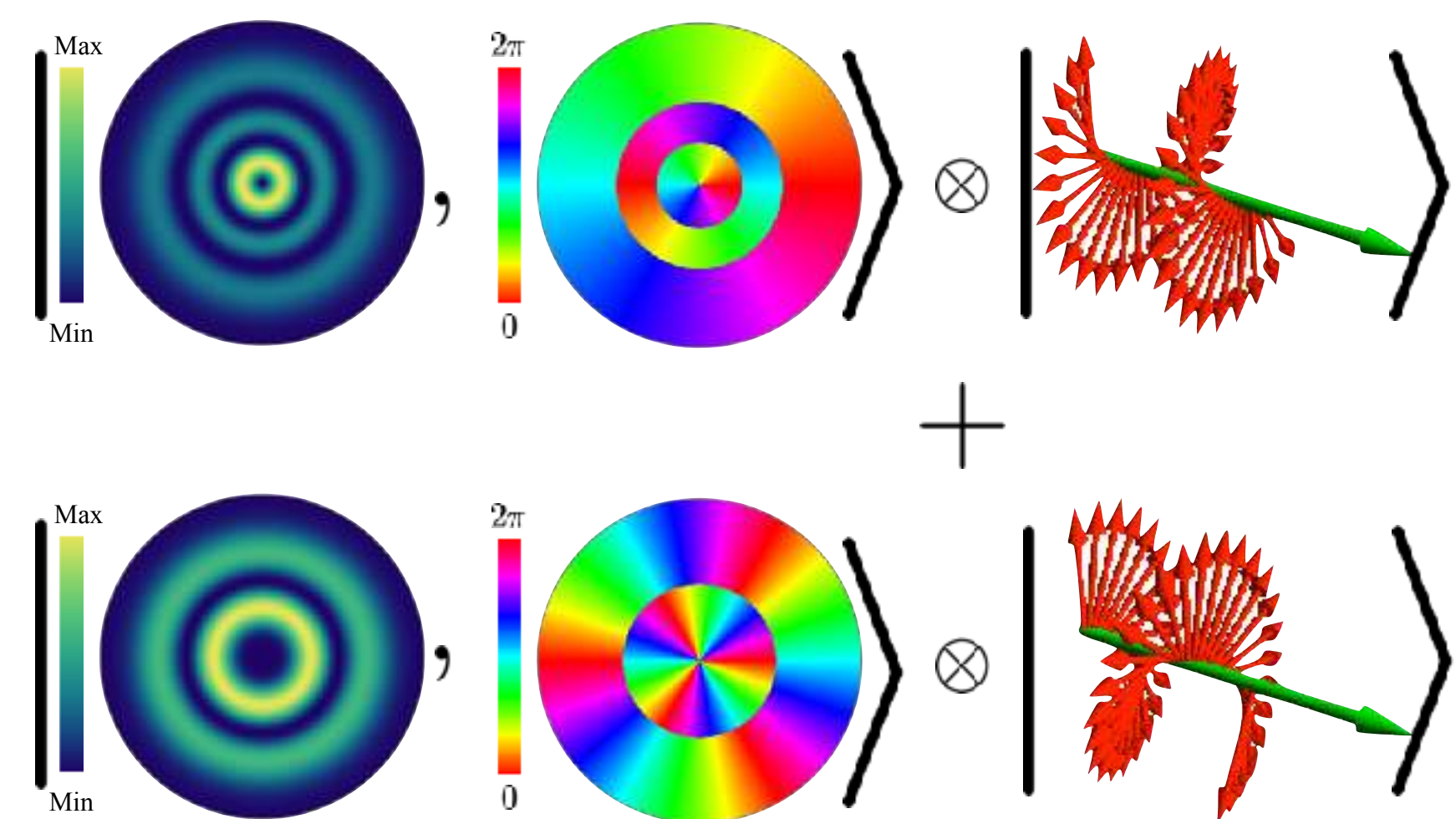

E. K. & E Santamato, *Optics Letters* **37**, 2484 (2012).

E. K., et al., *Phys. Rev. A* **89**, 063813 (2014).



Structured Photons

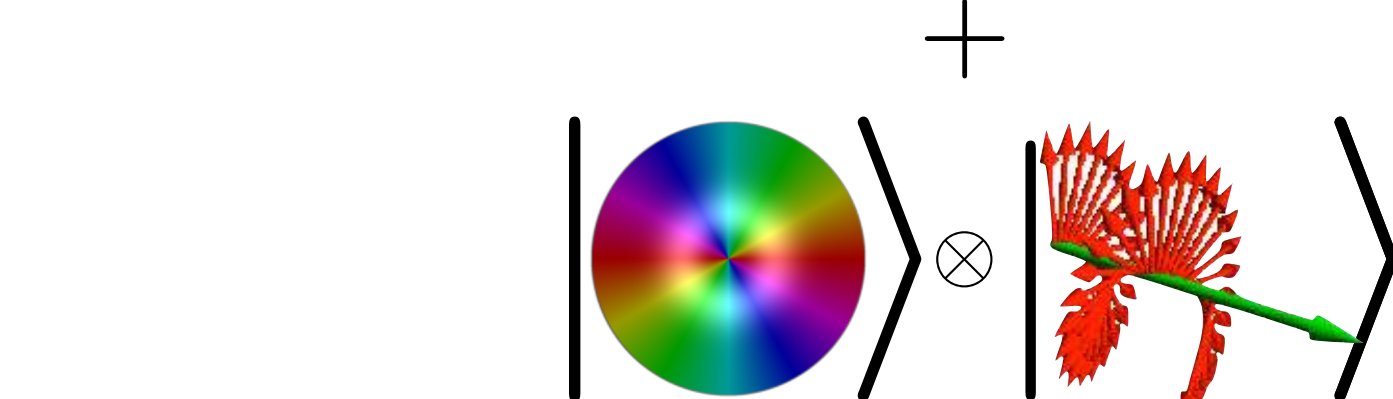
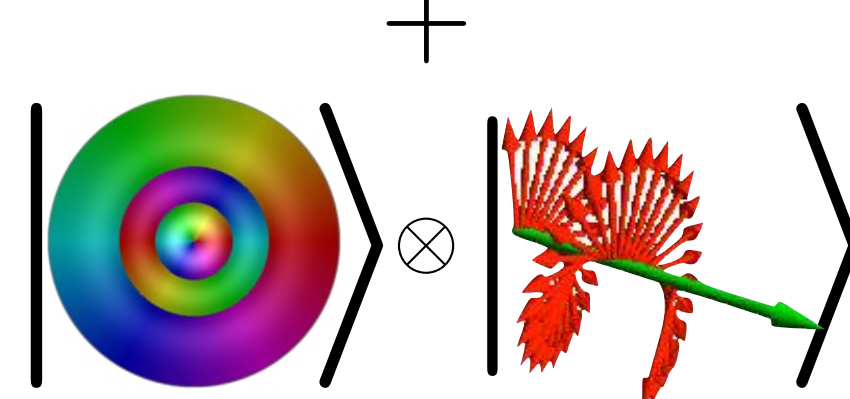
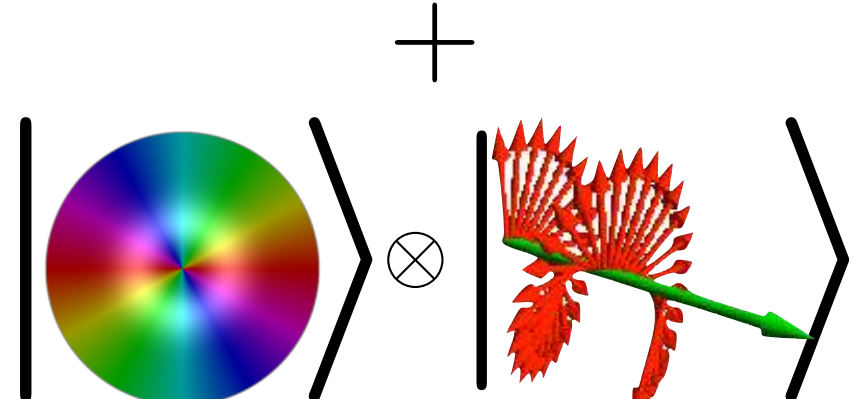
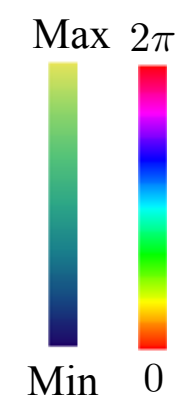
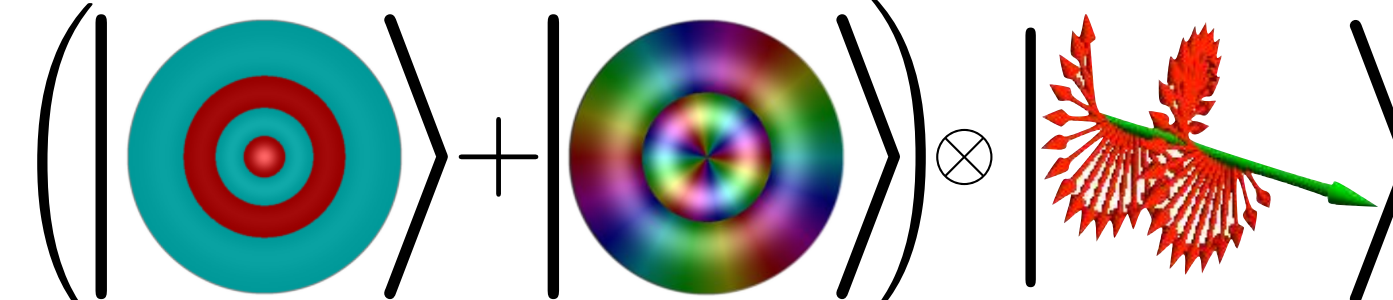
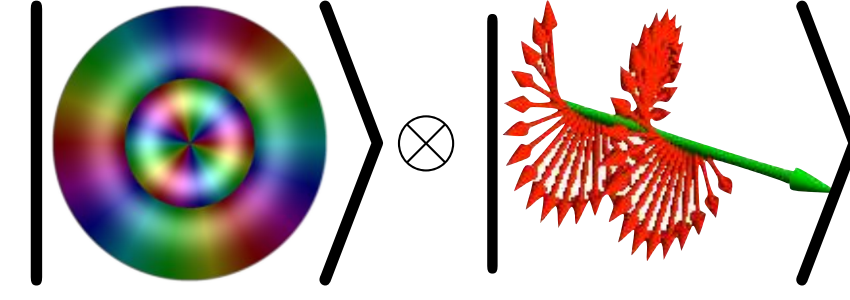
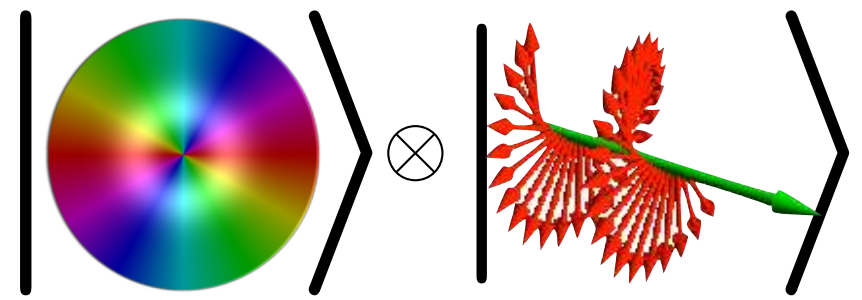
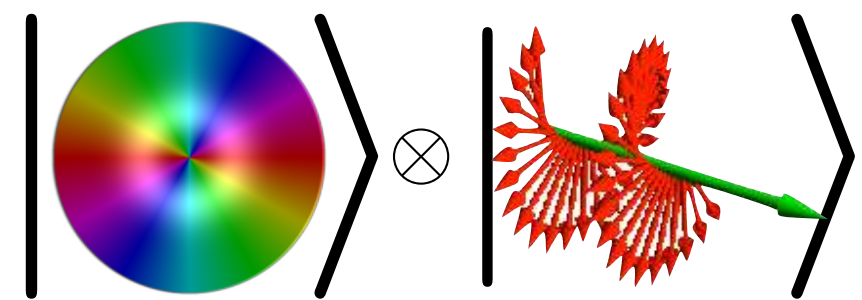
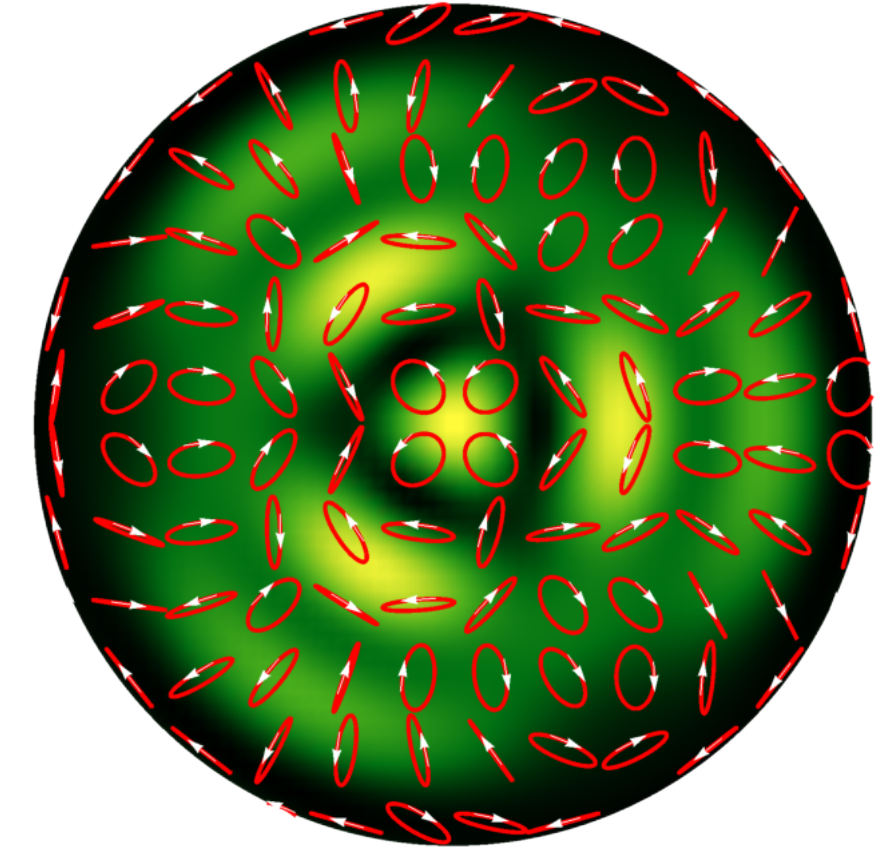
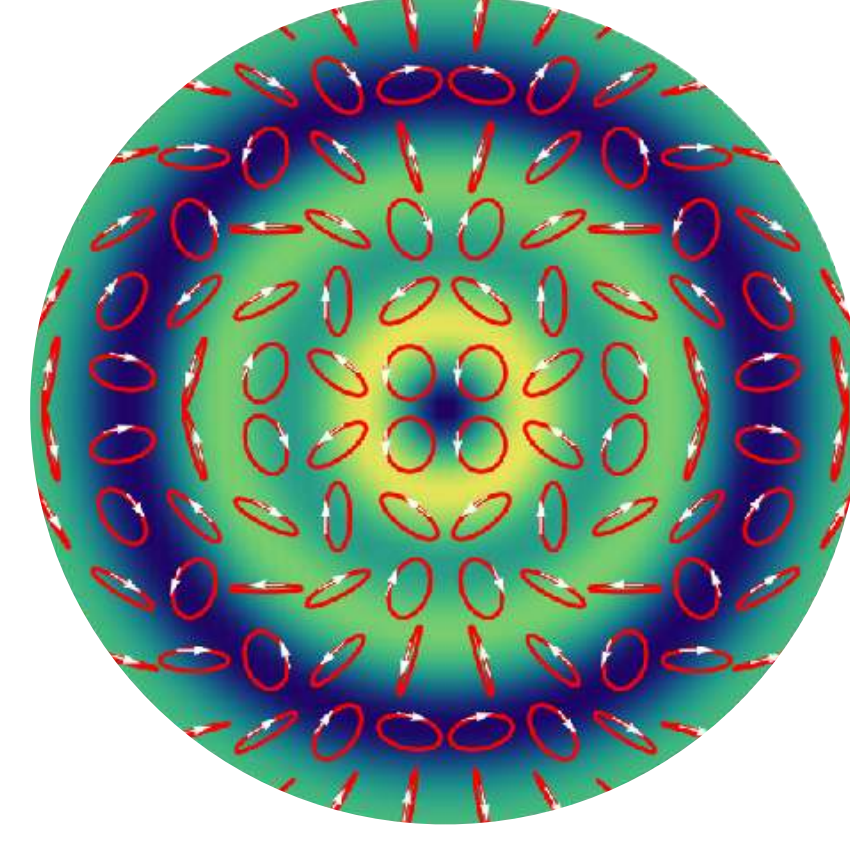
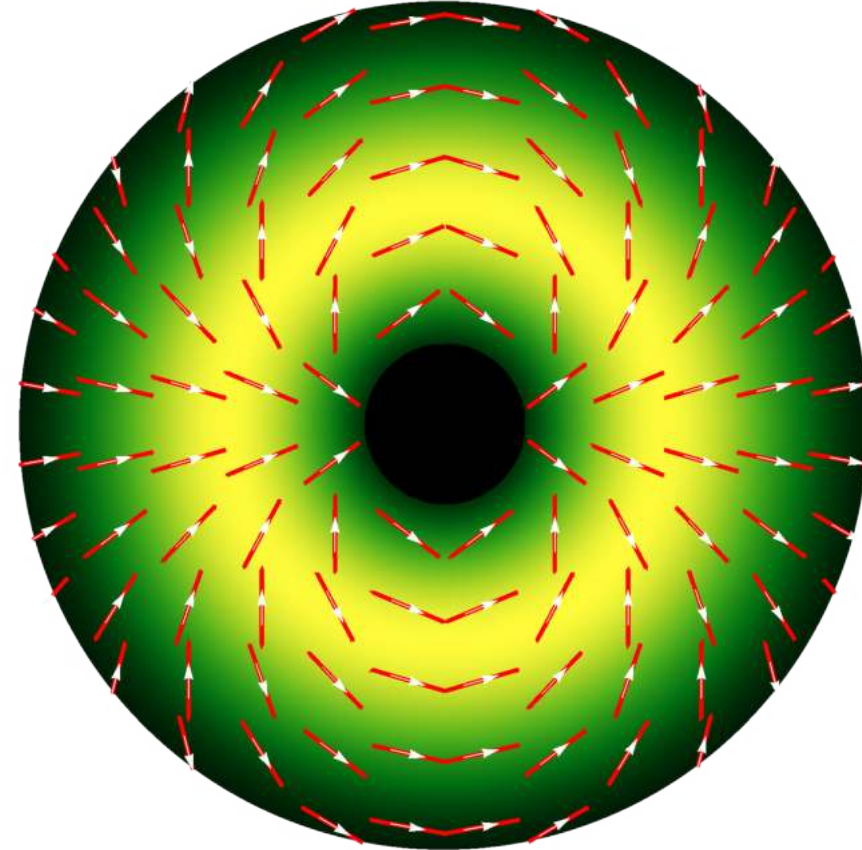
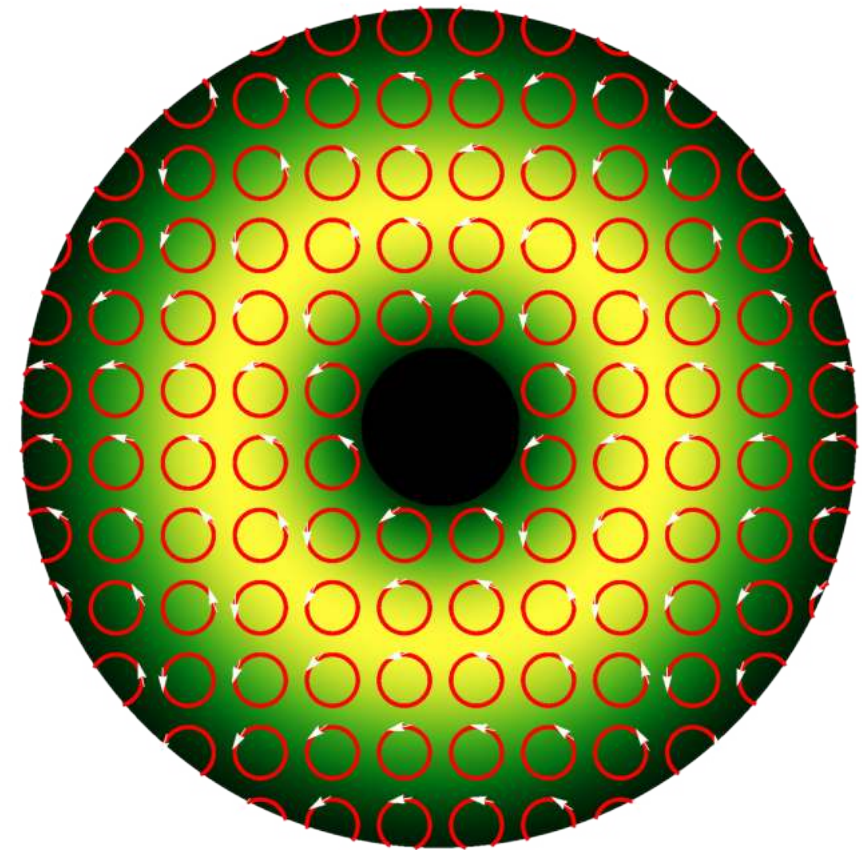

Generation: Liquid Crystal

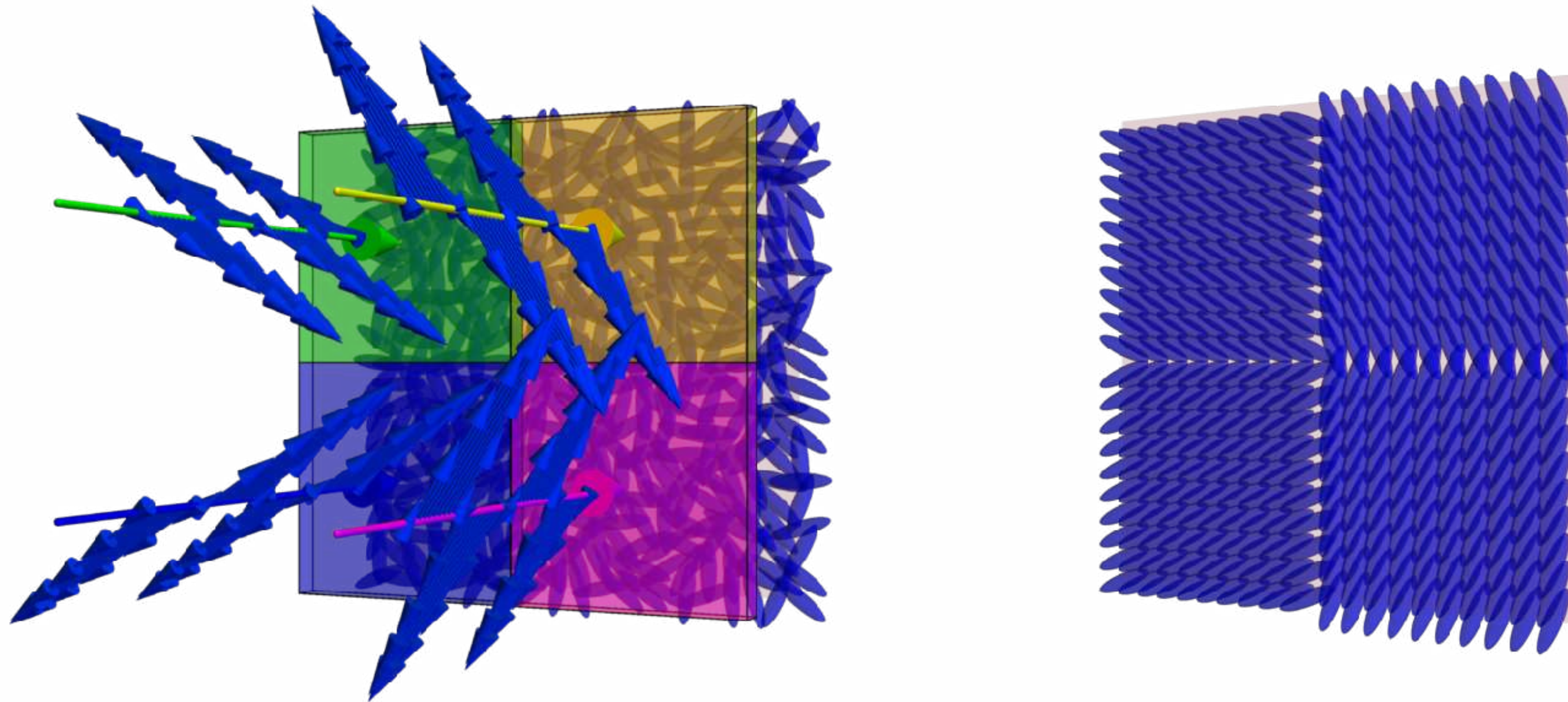

Generation: Liquid Crystal

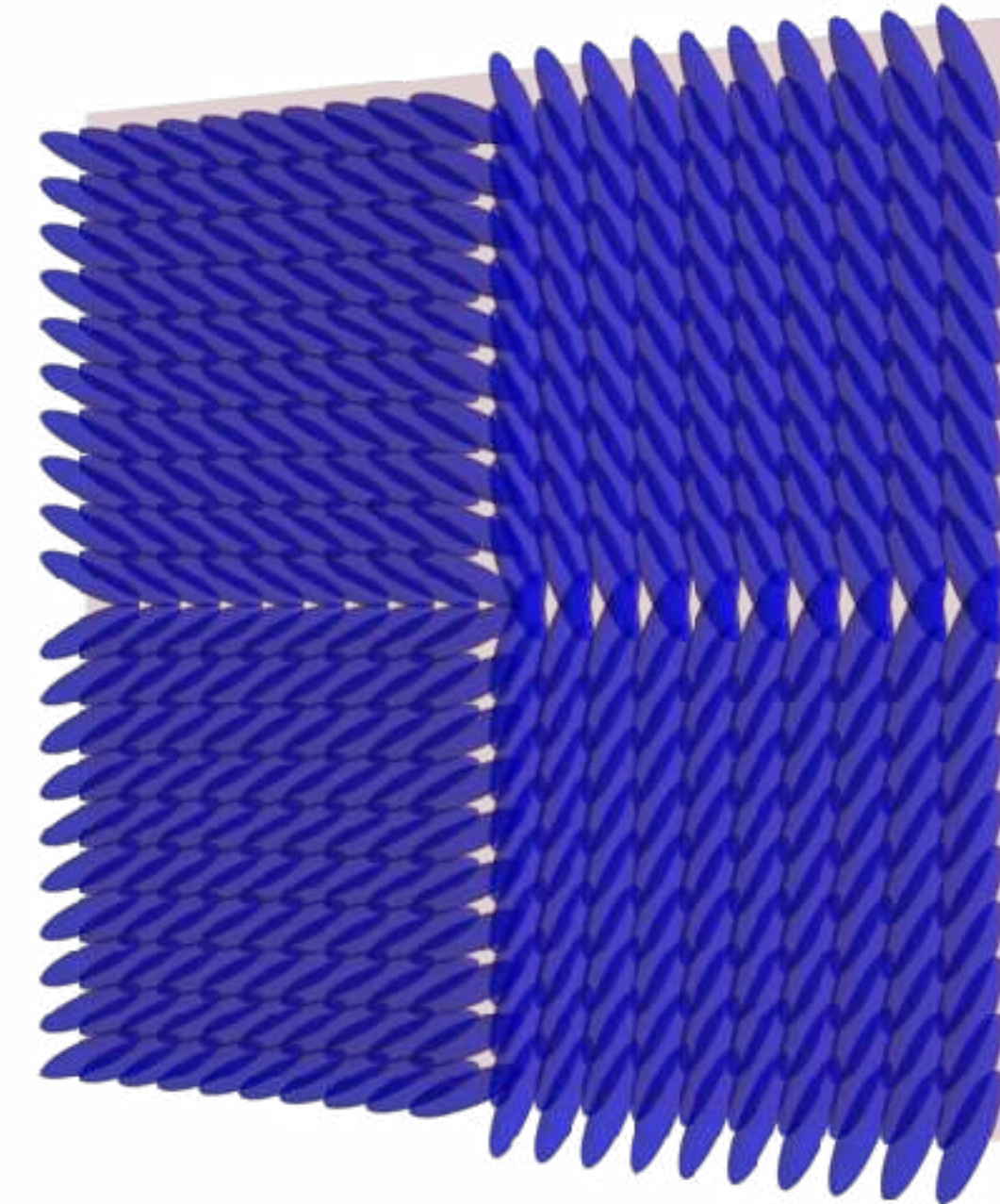
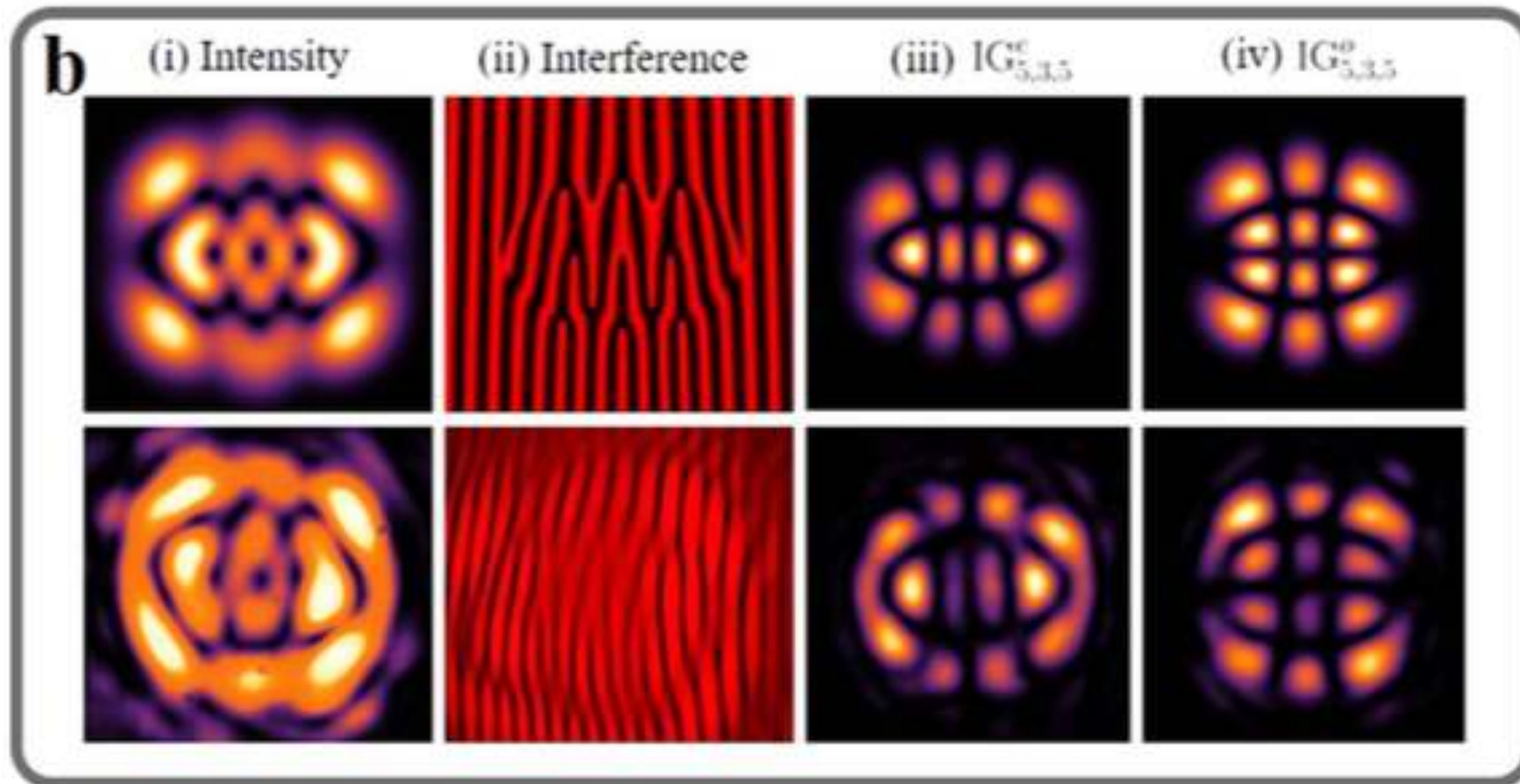
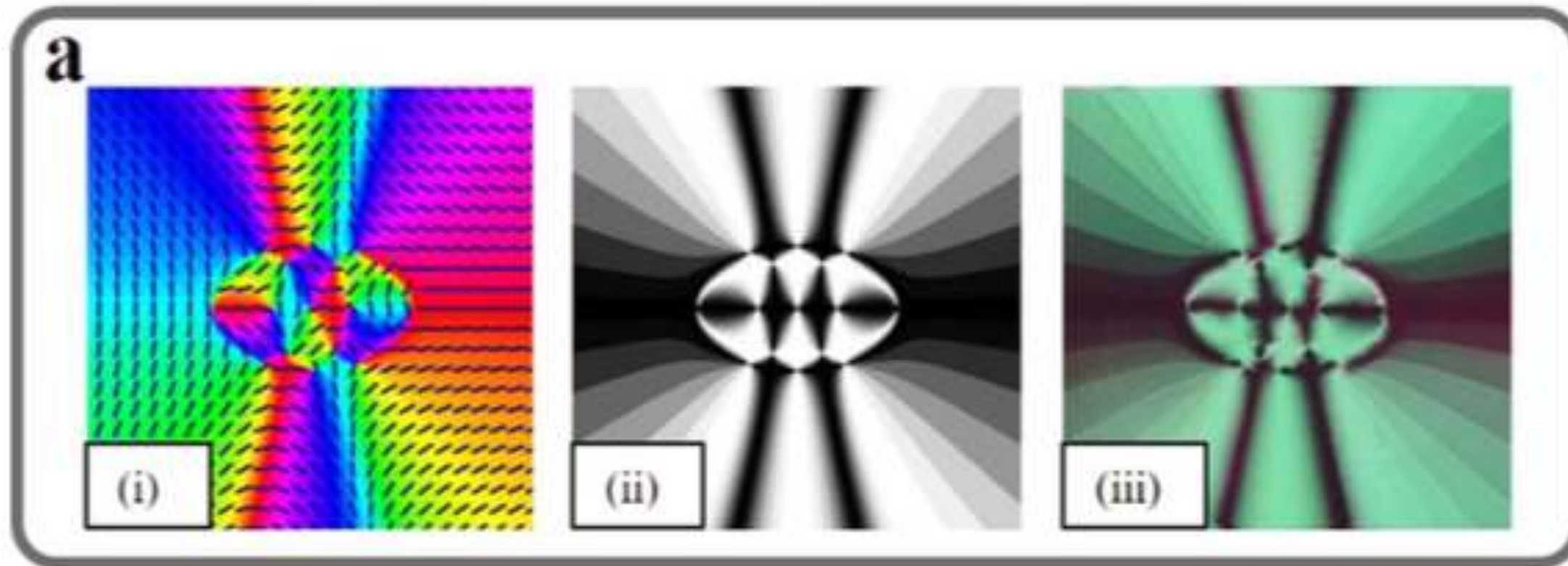

Generation: Liquid Crystal

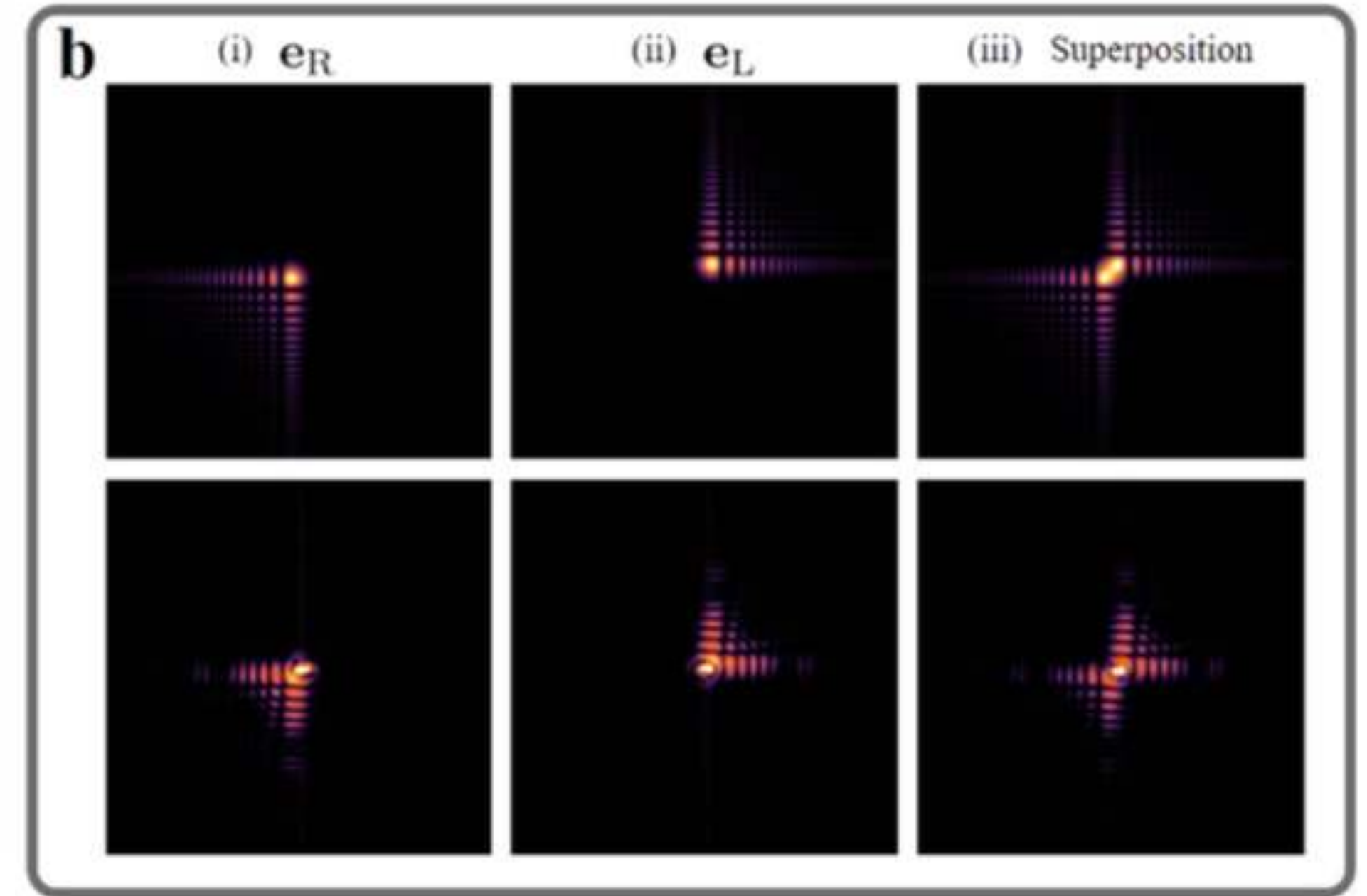
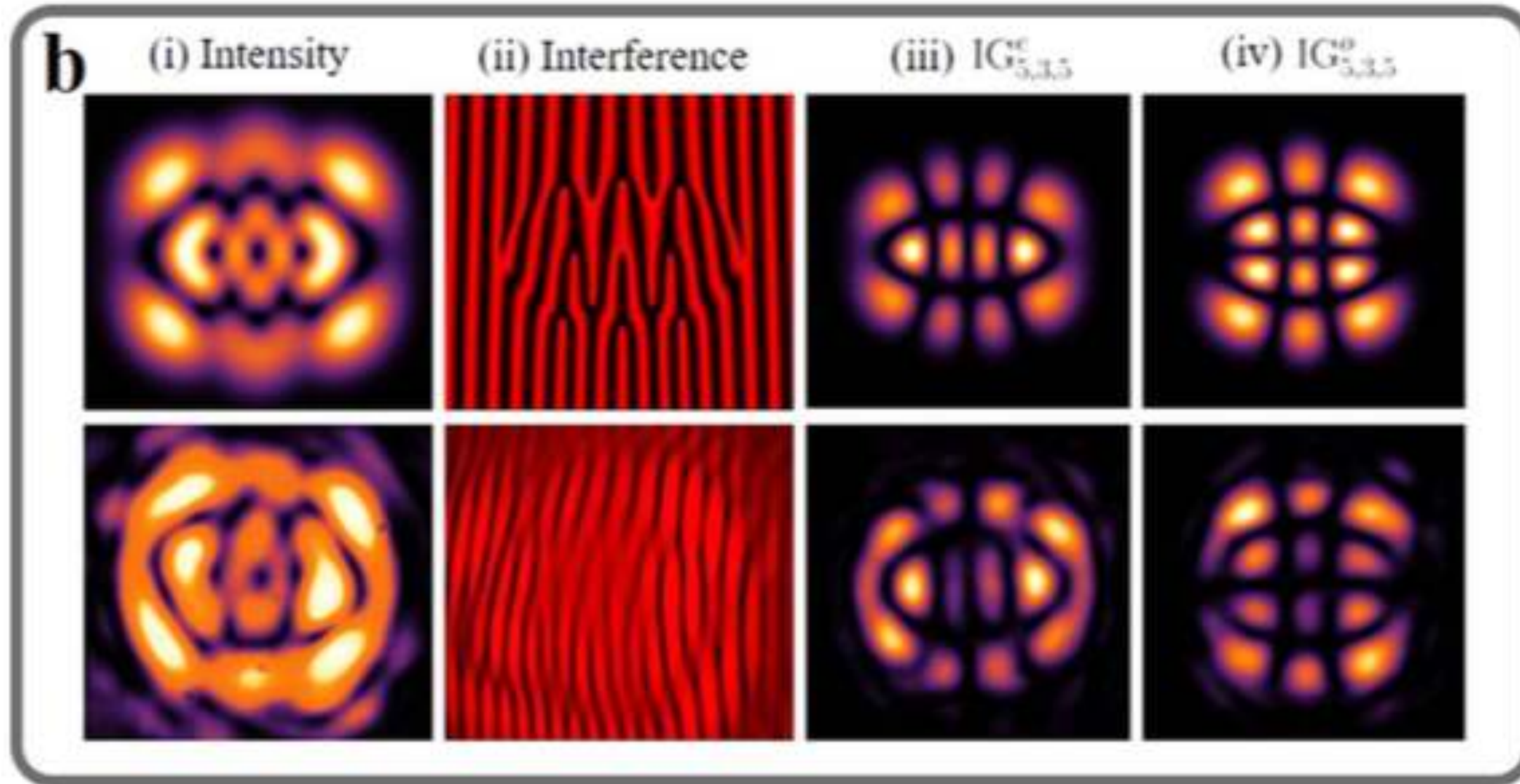
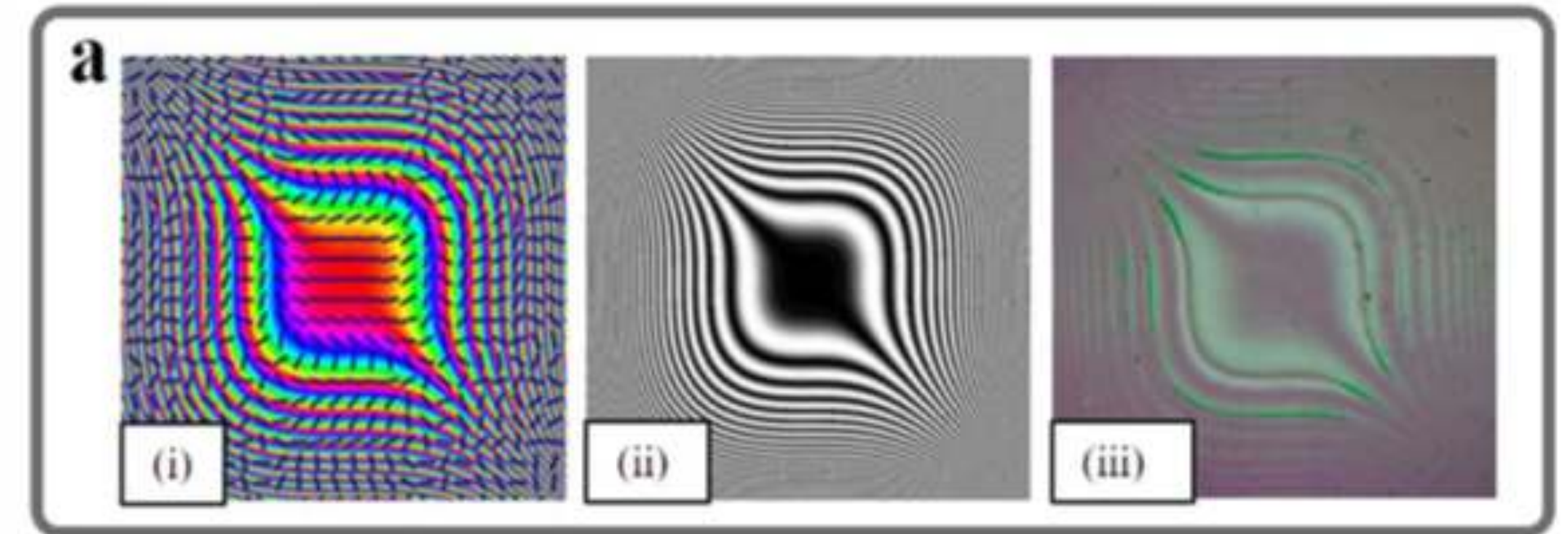
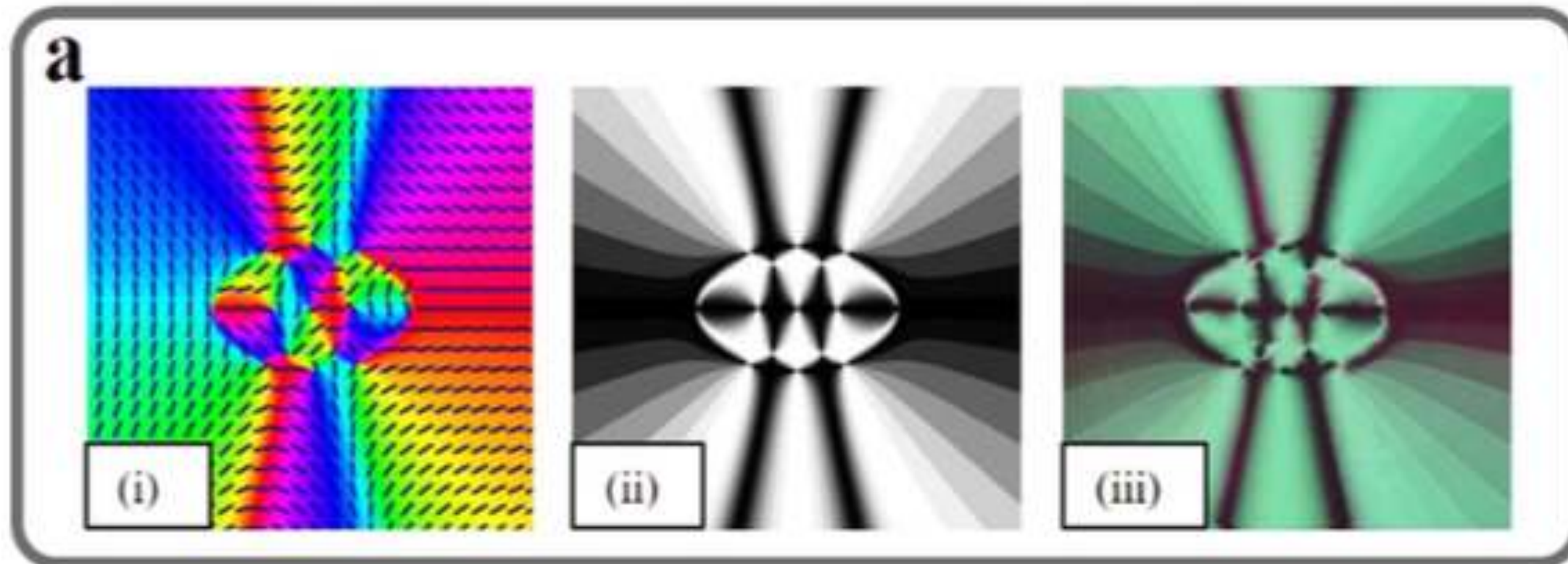

Generation: Liquid Crystal

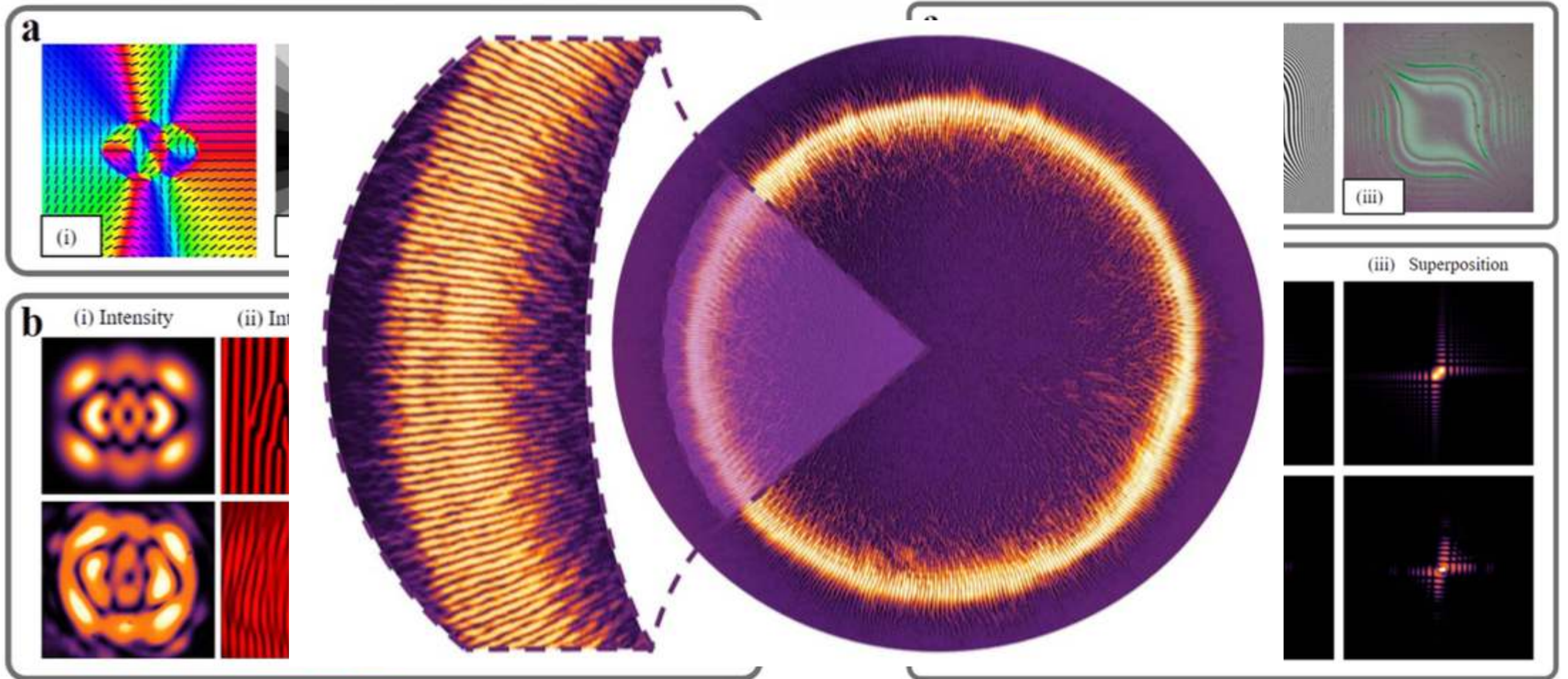

Polarisation topologies: polarisation singularity

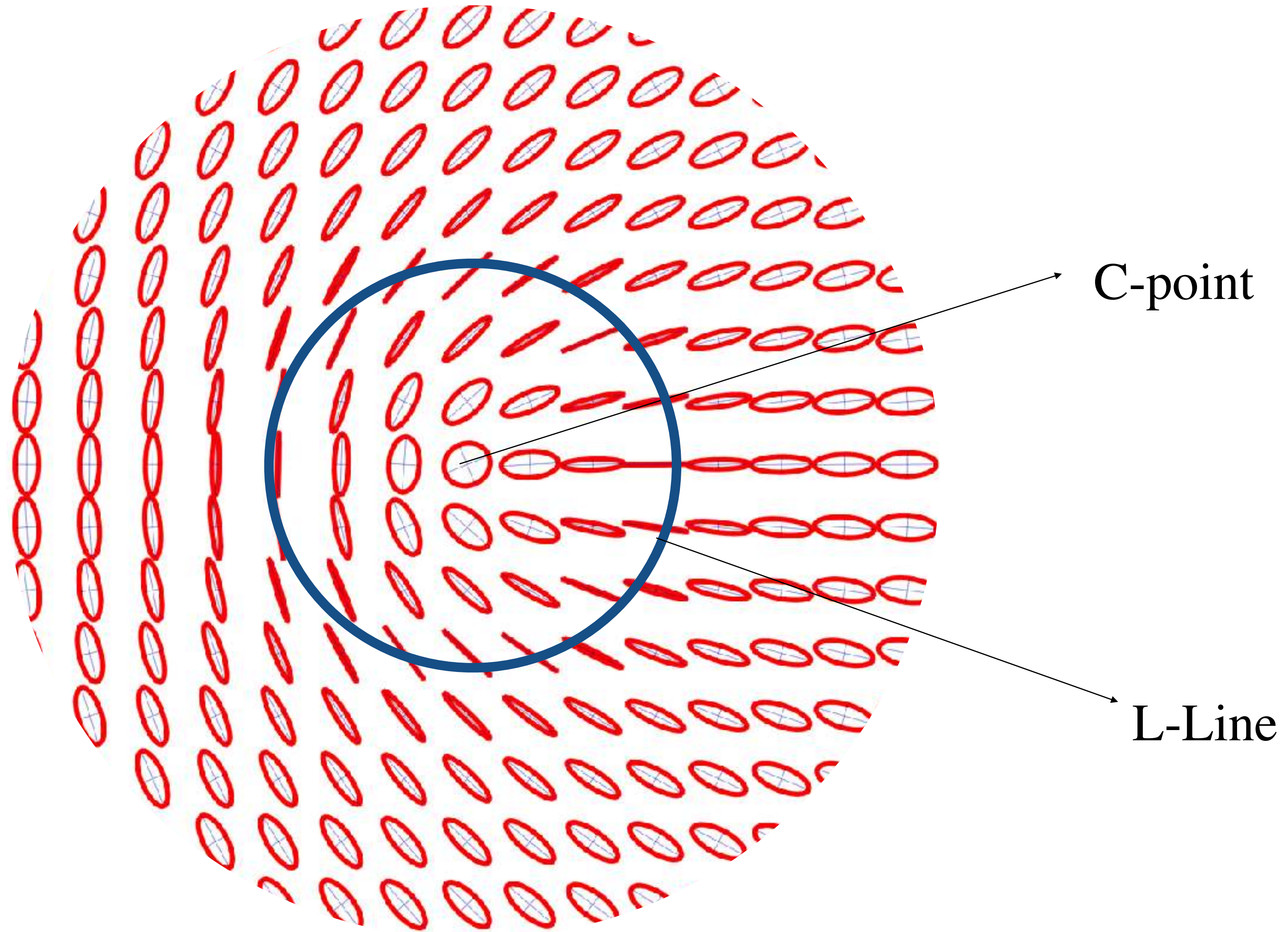

Major polarisation topologies

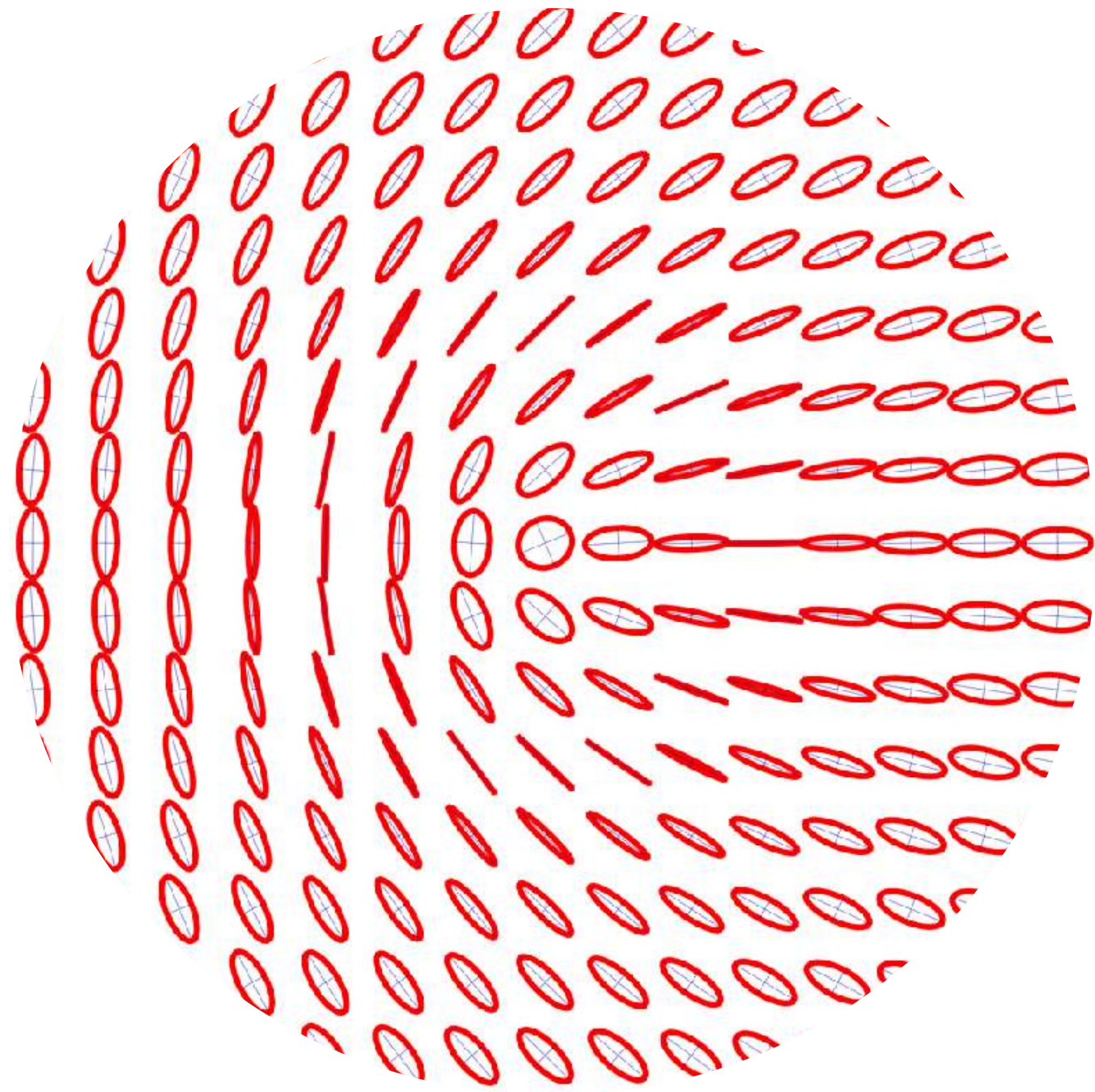

Lemon

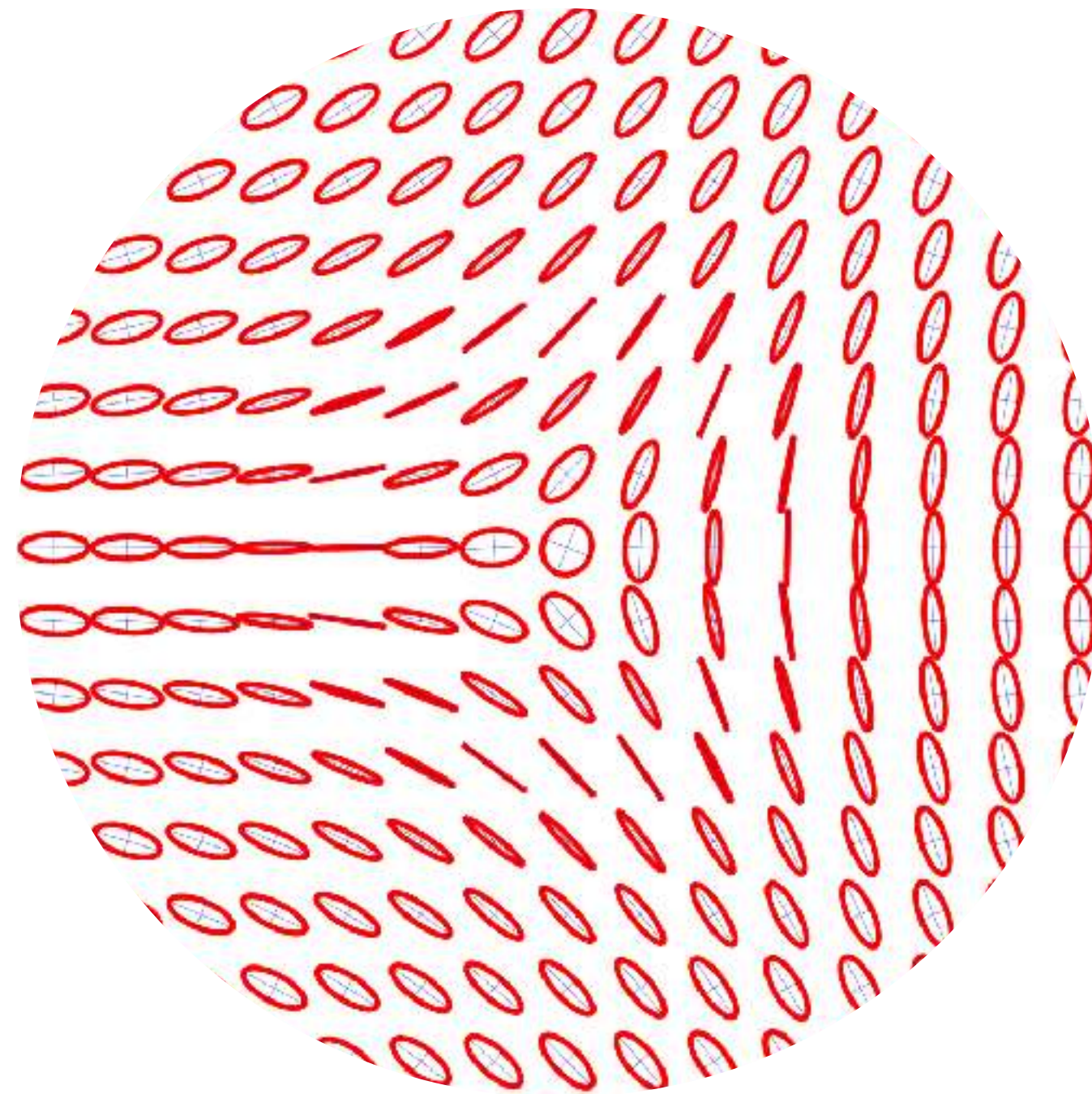

Star

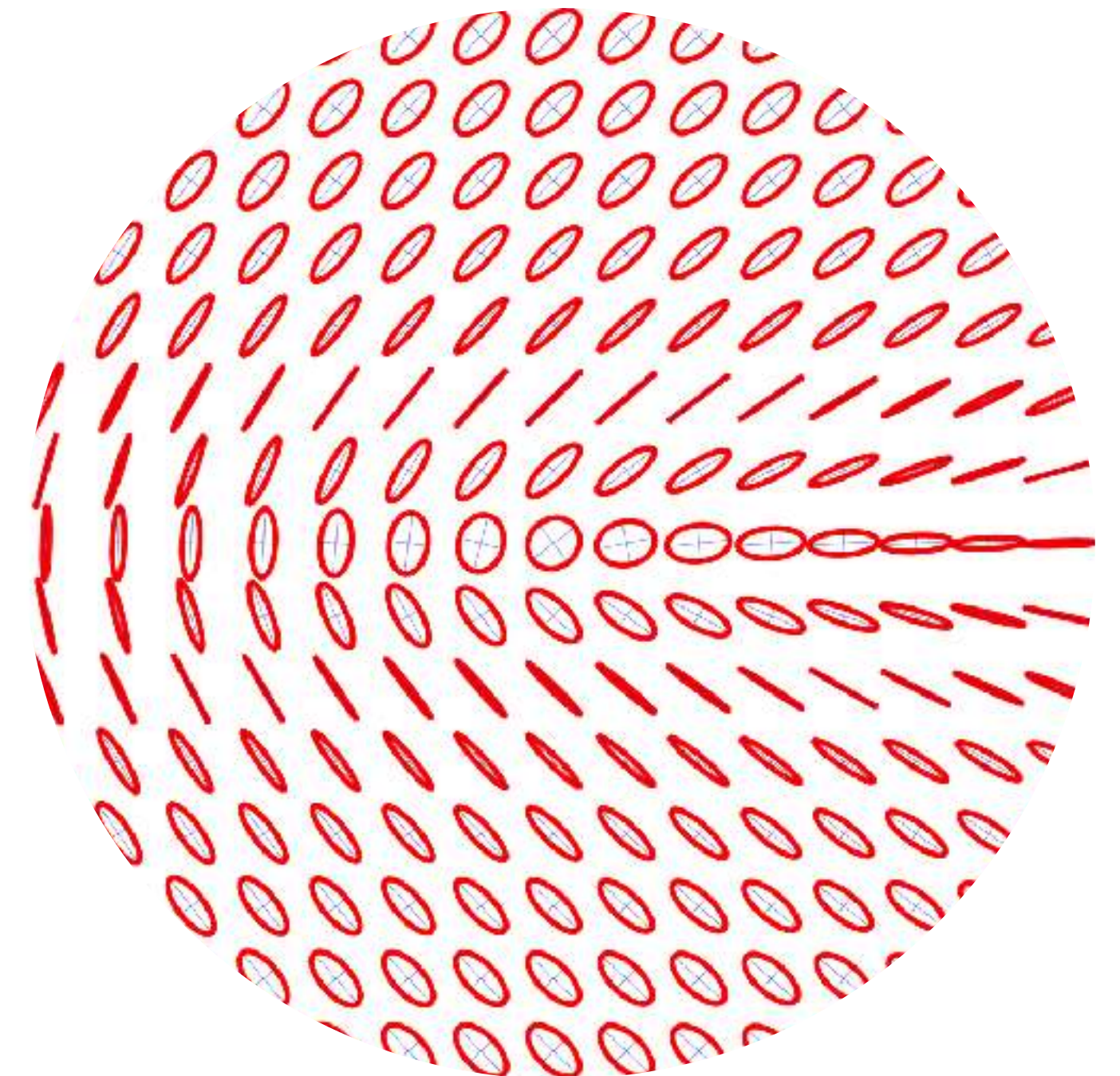

Monstar

3D Polarisation Topologies

Möbius

Knots

Framed Knots

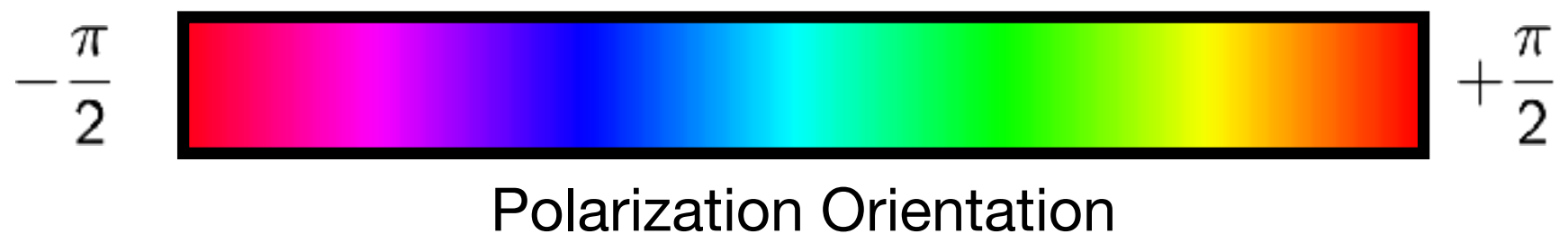
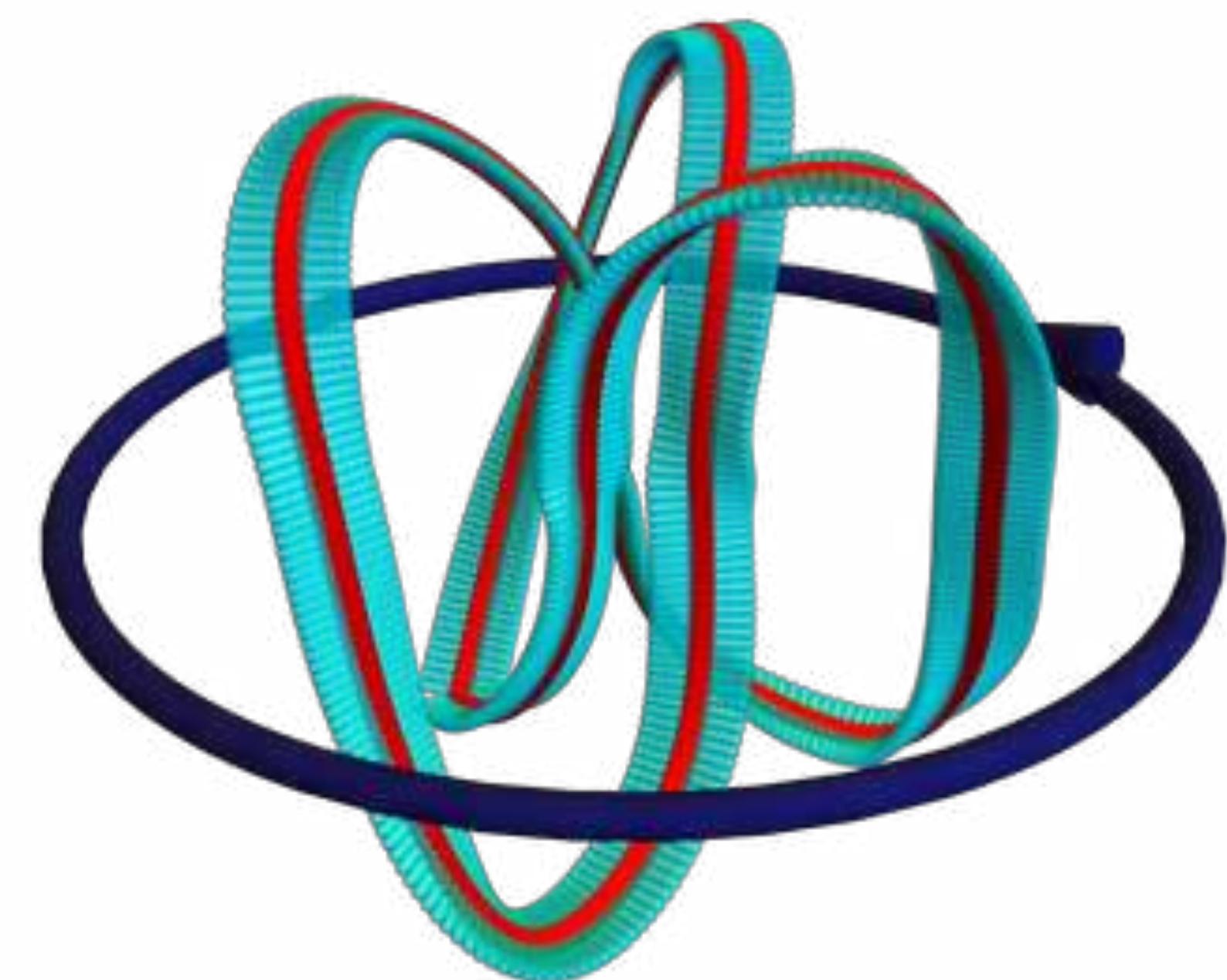
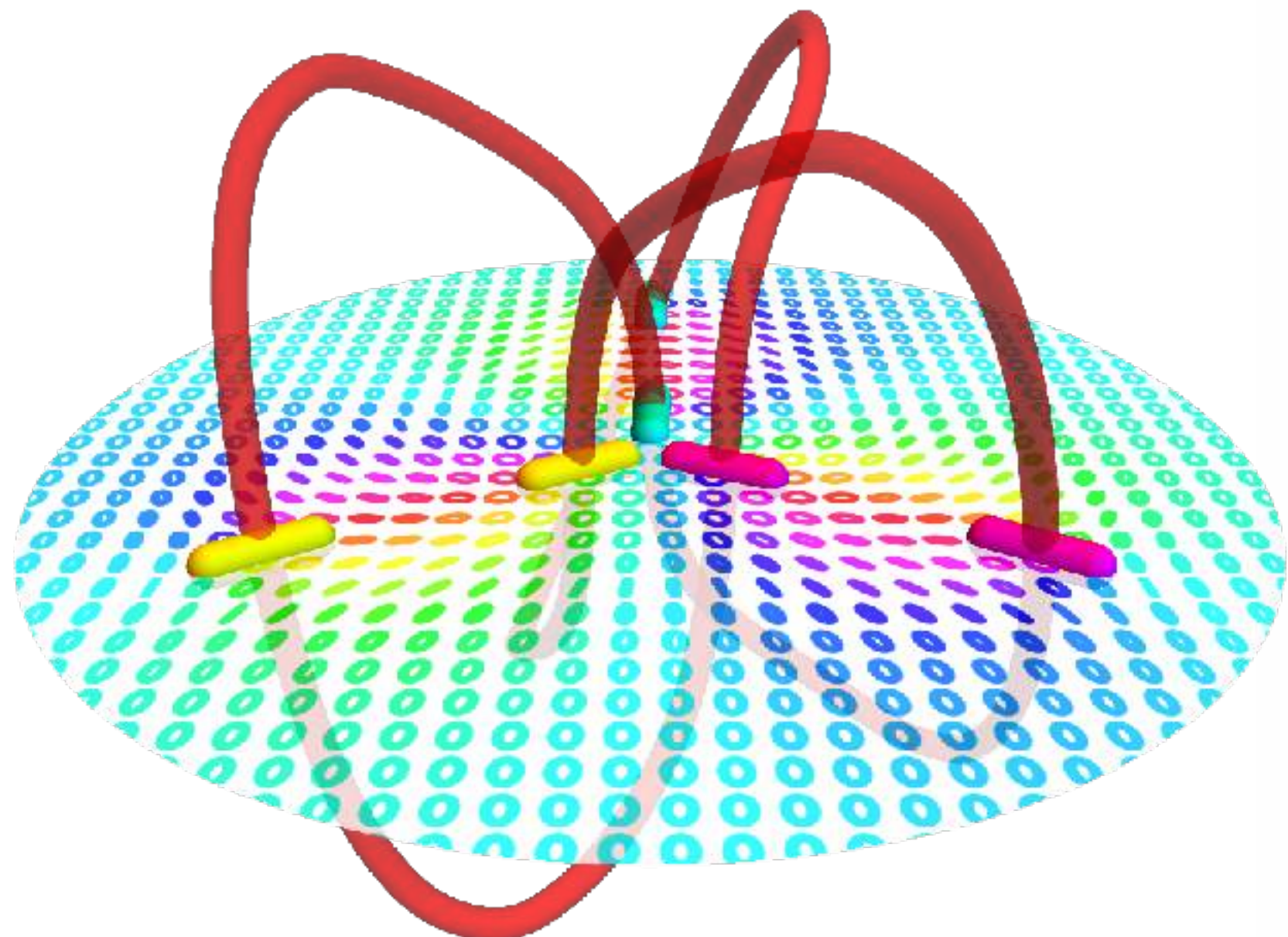
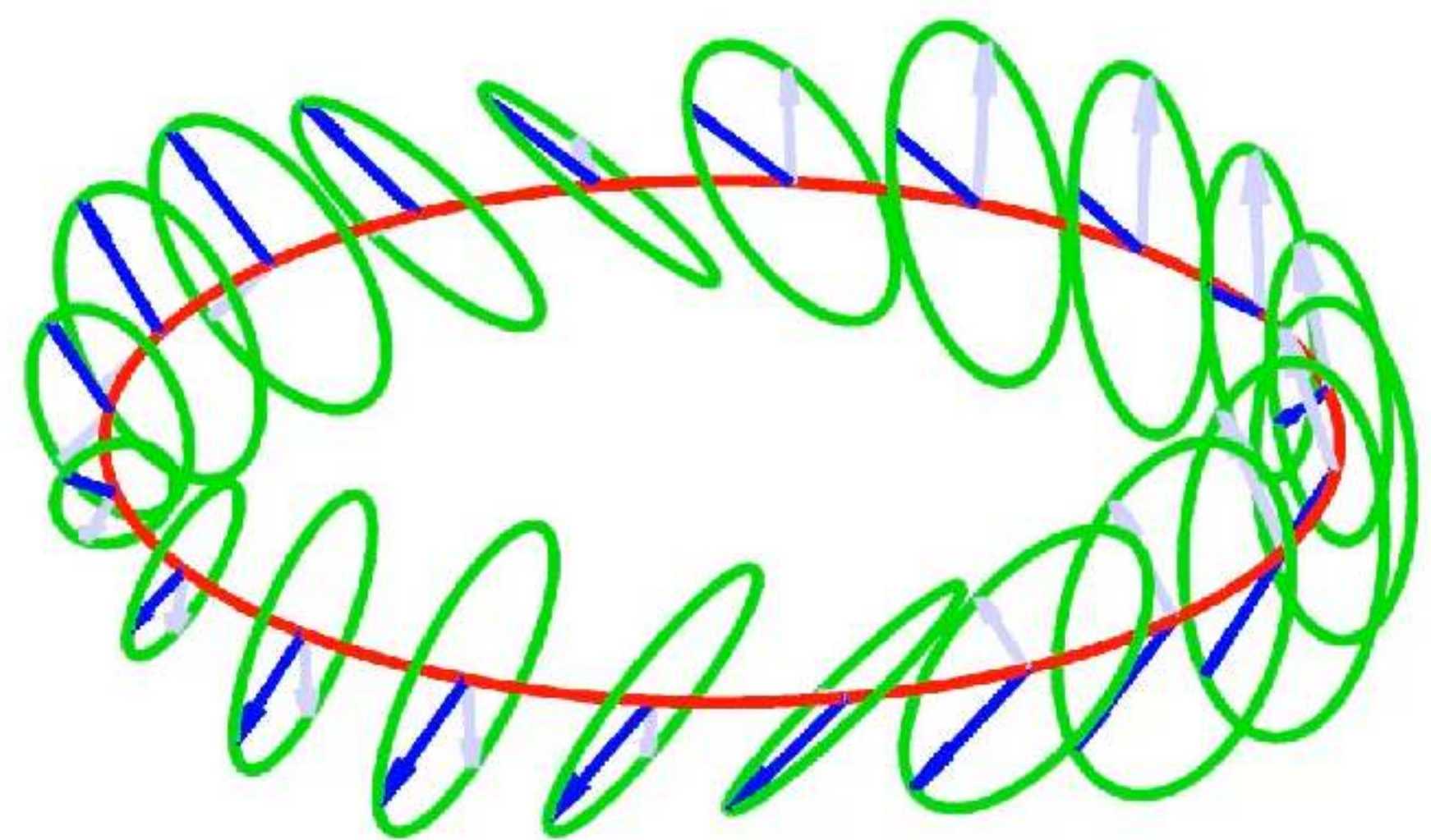

H Larocque, A D'Errico, M Ferrer, A Carmy, E Cohen & E. K., *Nature Communications* **11**, 5119 (2020).
 H Larocque, D Sugic, D Mortimer, A J Taylor, R Fickler, R W Boyd, M R Dennis & E. K. *Nature Physics* **14**, 1079 (2018).
 T Bauer, P Banzer, E. K., S Orlov, A Rubano, L Marrucci, E Santamato, R W Boyd, G Leuchs, *Science* **29**, 1260635 (2015).

3D Polarisation Topologies

Möbius

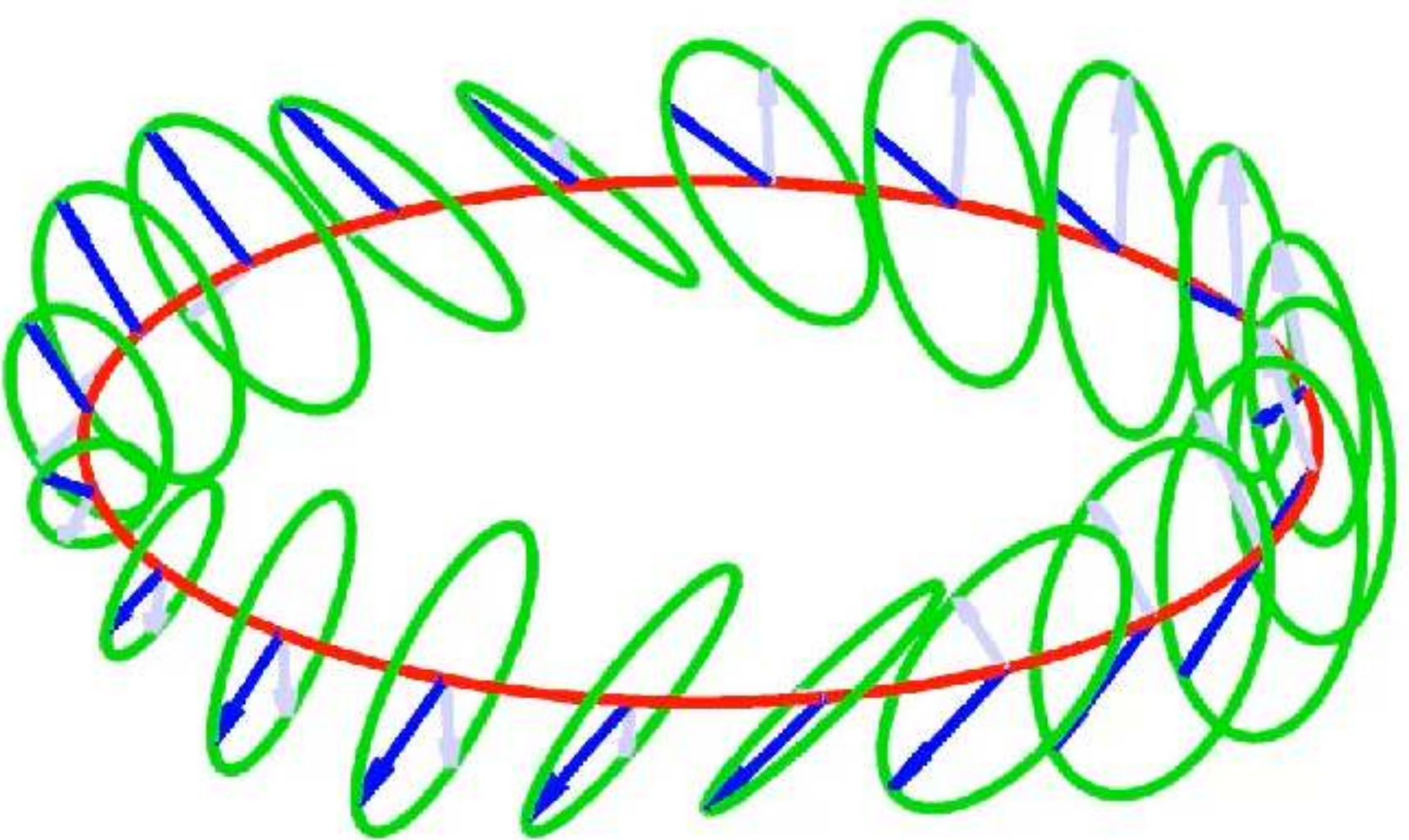

Knots

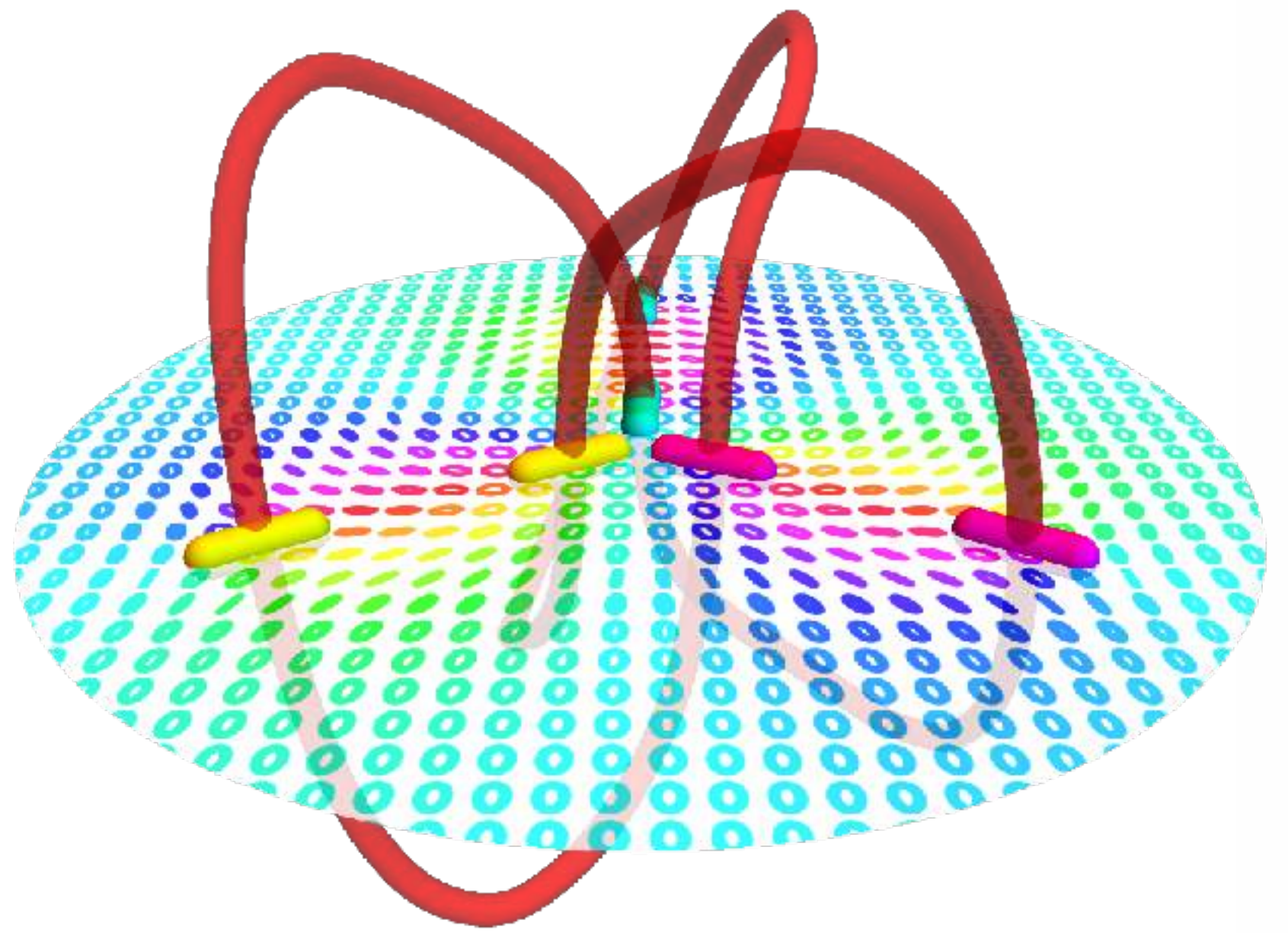

Framed Knots

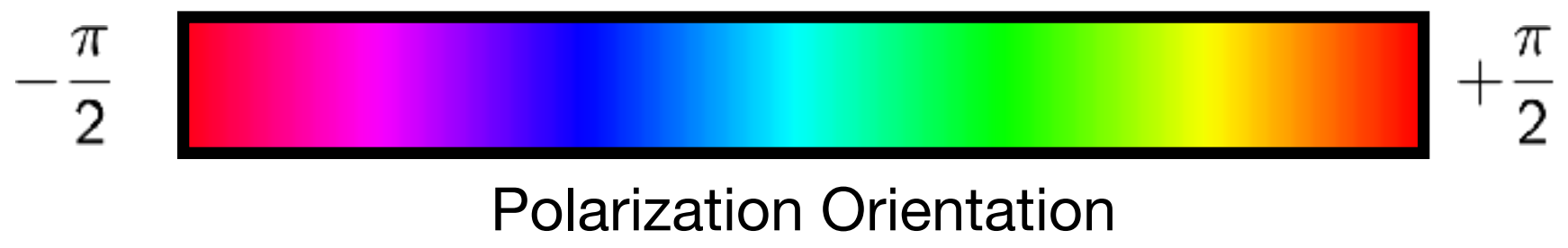
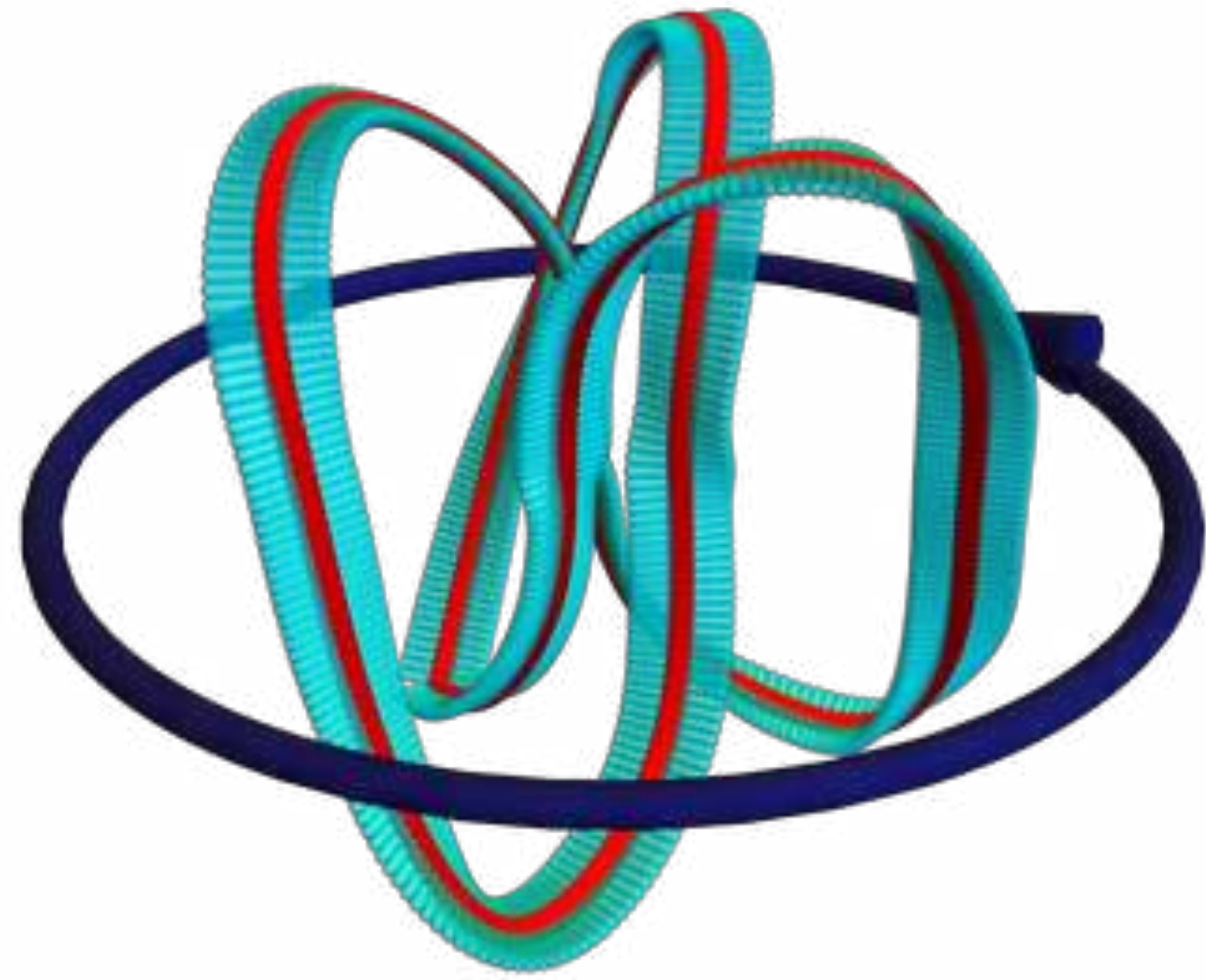

Framed-Knot as information carrier

Encode a large integer N in prime numbers as follows

- Assign to each strand a prime number p_k
- In each strand the number of half twists is d_k (if there are no twists $d_k = -\infty$)
- Choose a positive number α (to be shared with the receiver)
- The integer N is given by
$$N = \prod_{k=1}^n p_k^{(\alpha) d_k}$$

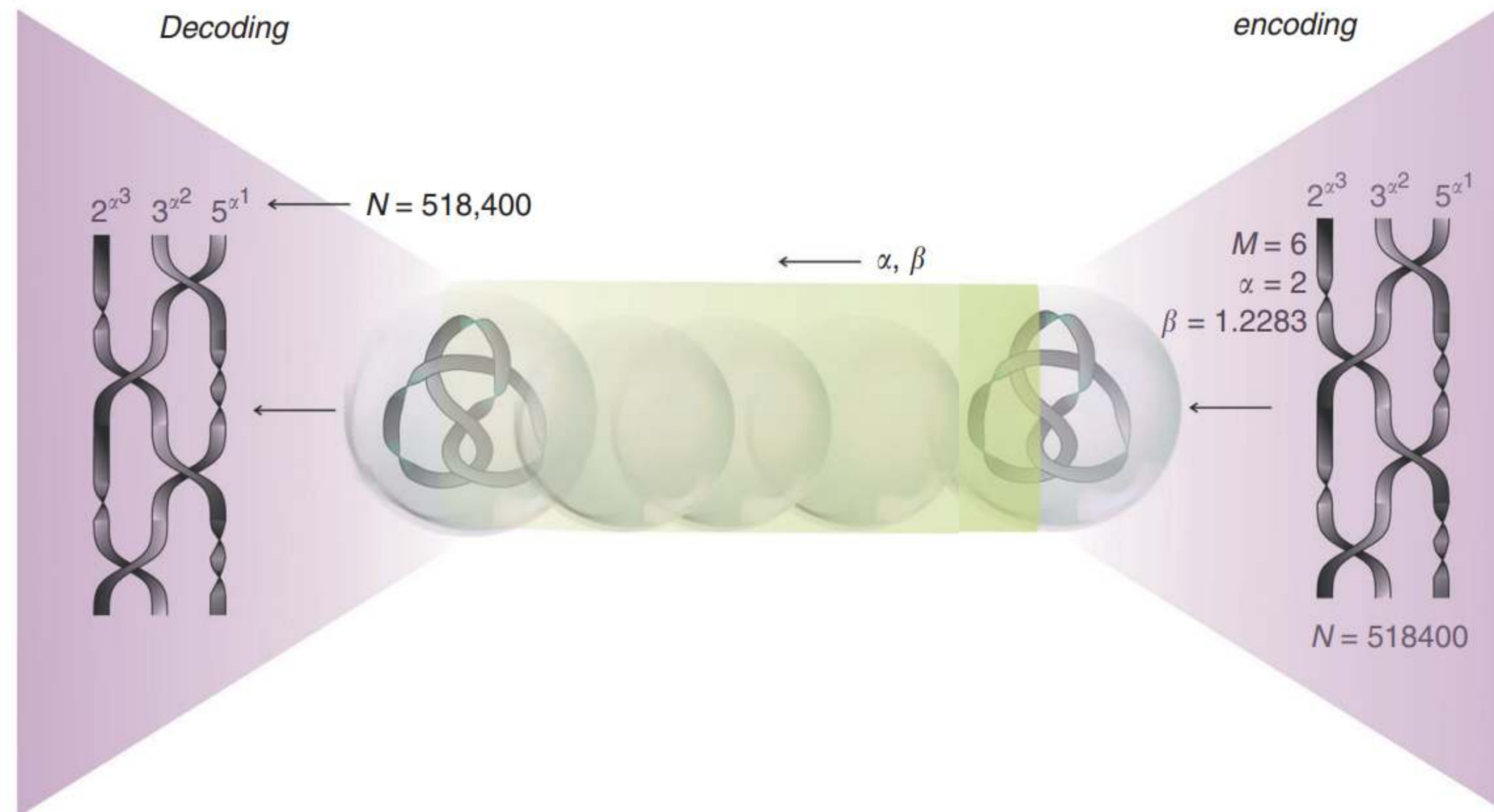

Novel Topologies: Polychromatic structured Light

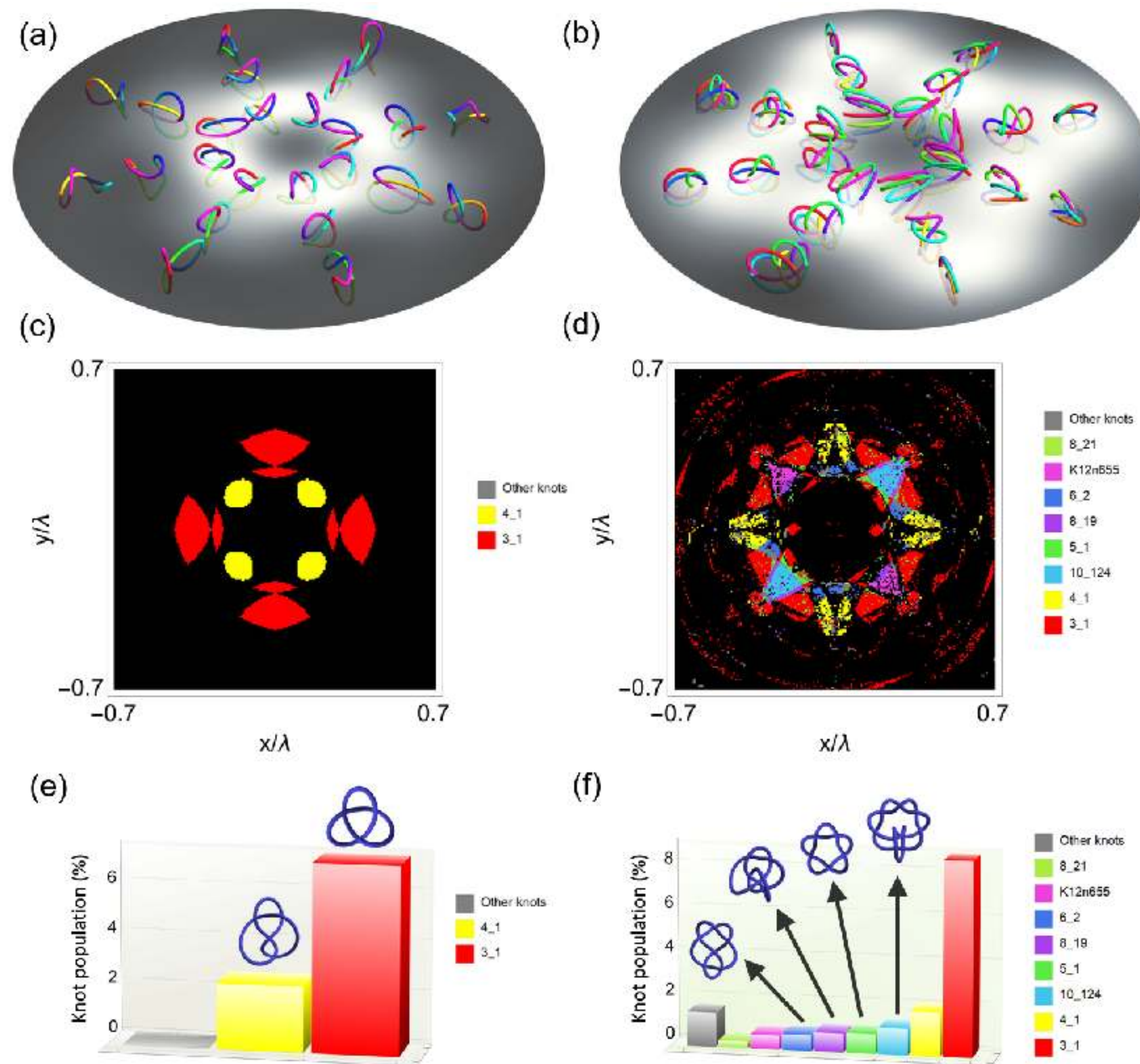
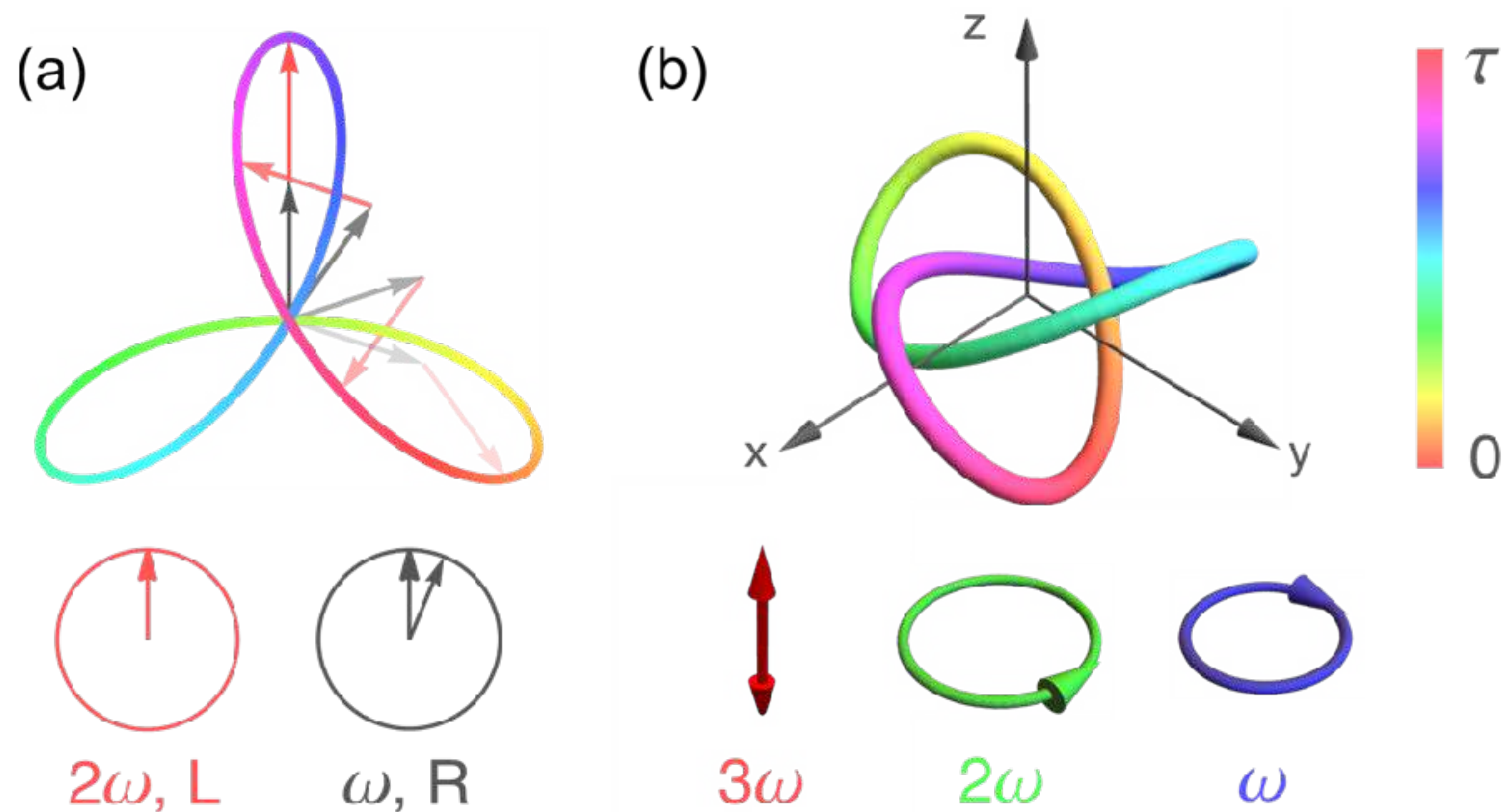

Structured Light at XUV regime

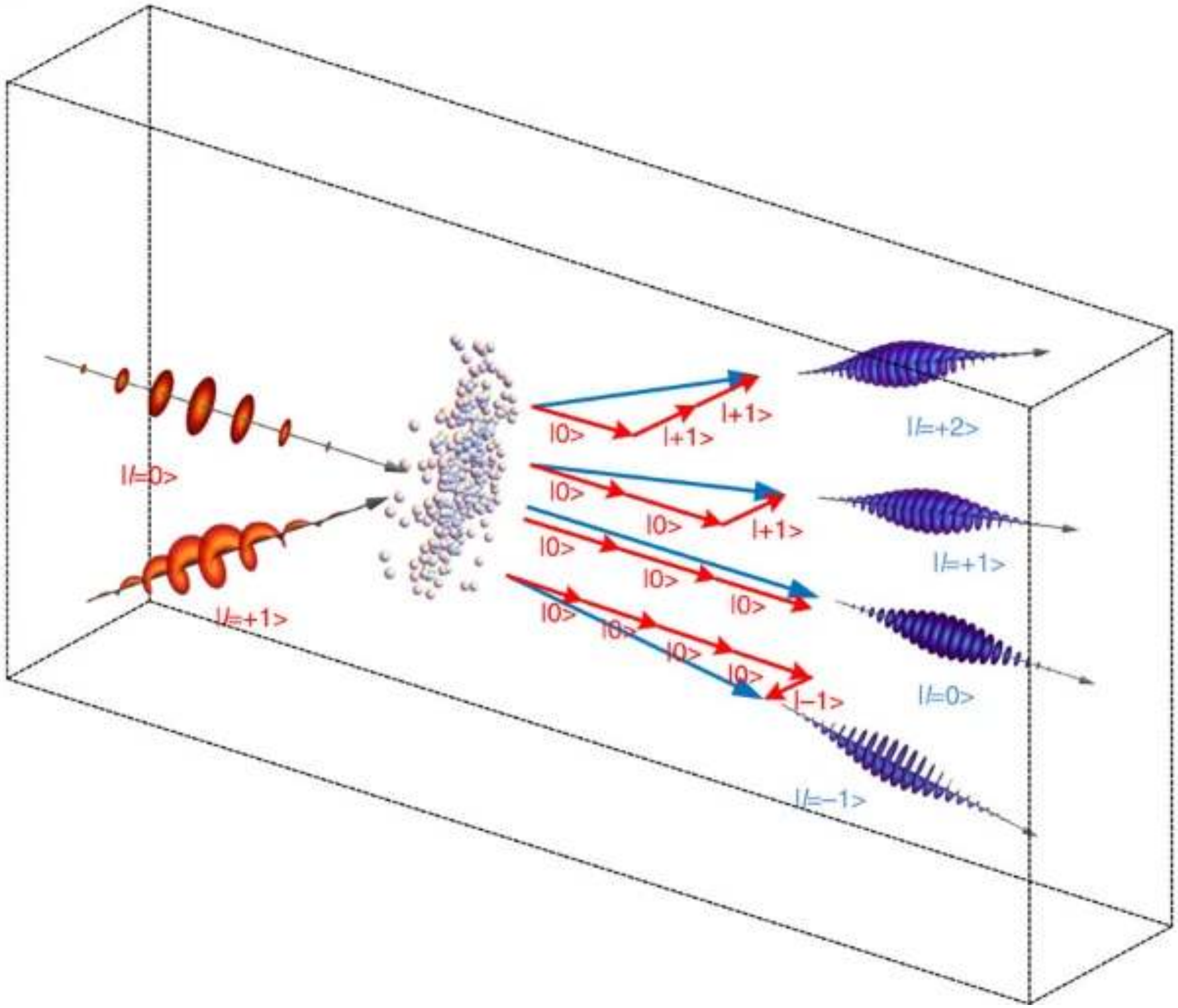
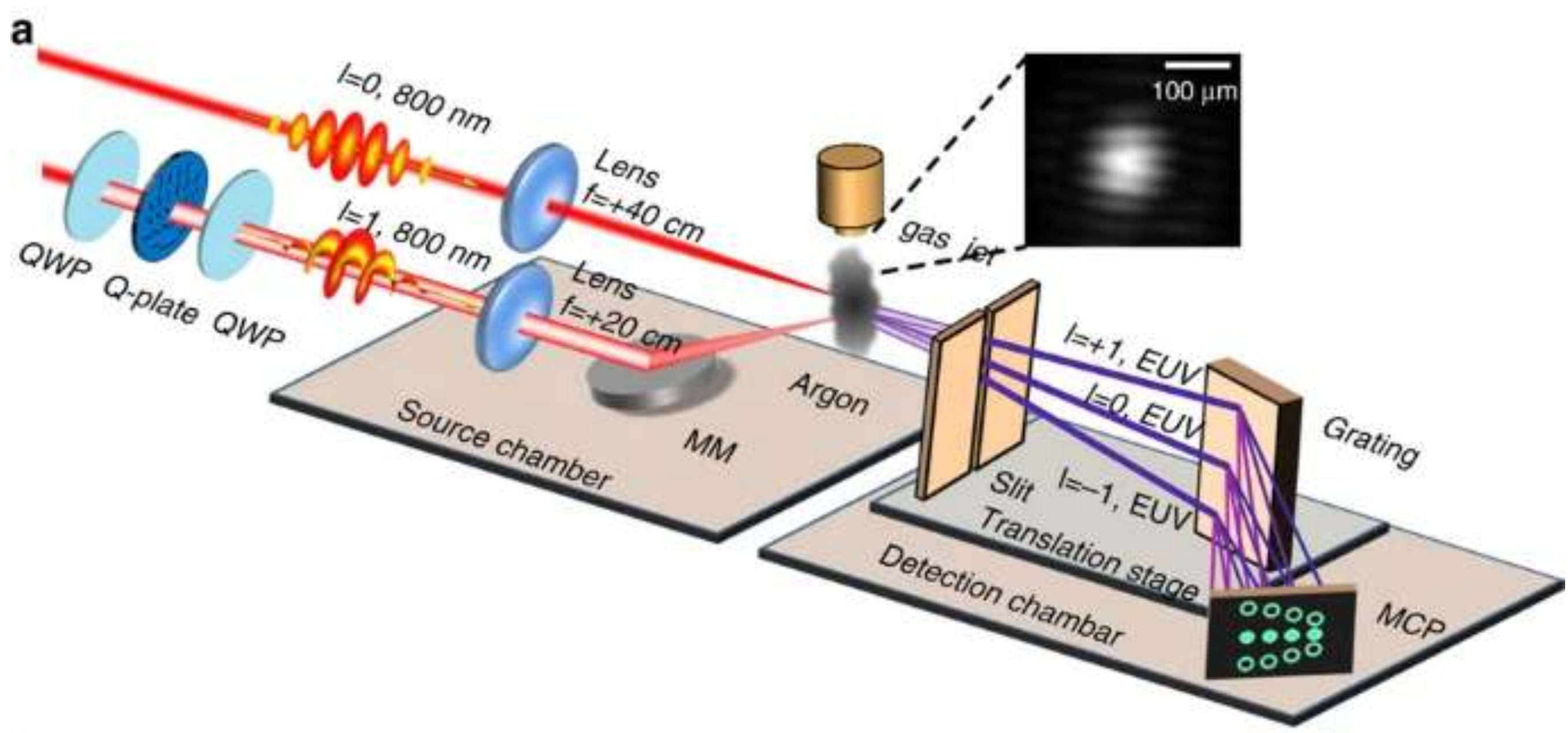

F Kong, C Zhang, F Bouchard, Z Li, G G Brown, D H Ko, T J Hammond, L Arissian, R W Boyd, E.K. & P B Corkum, *Nature Communications* **8**, 14970 (2017).



Structured Light at XUV regime

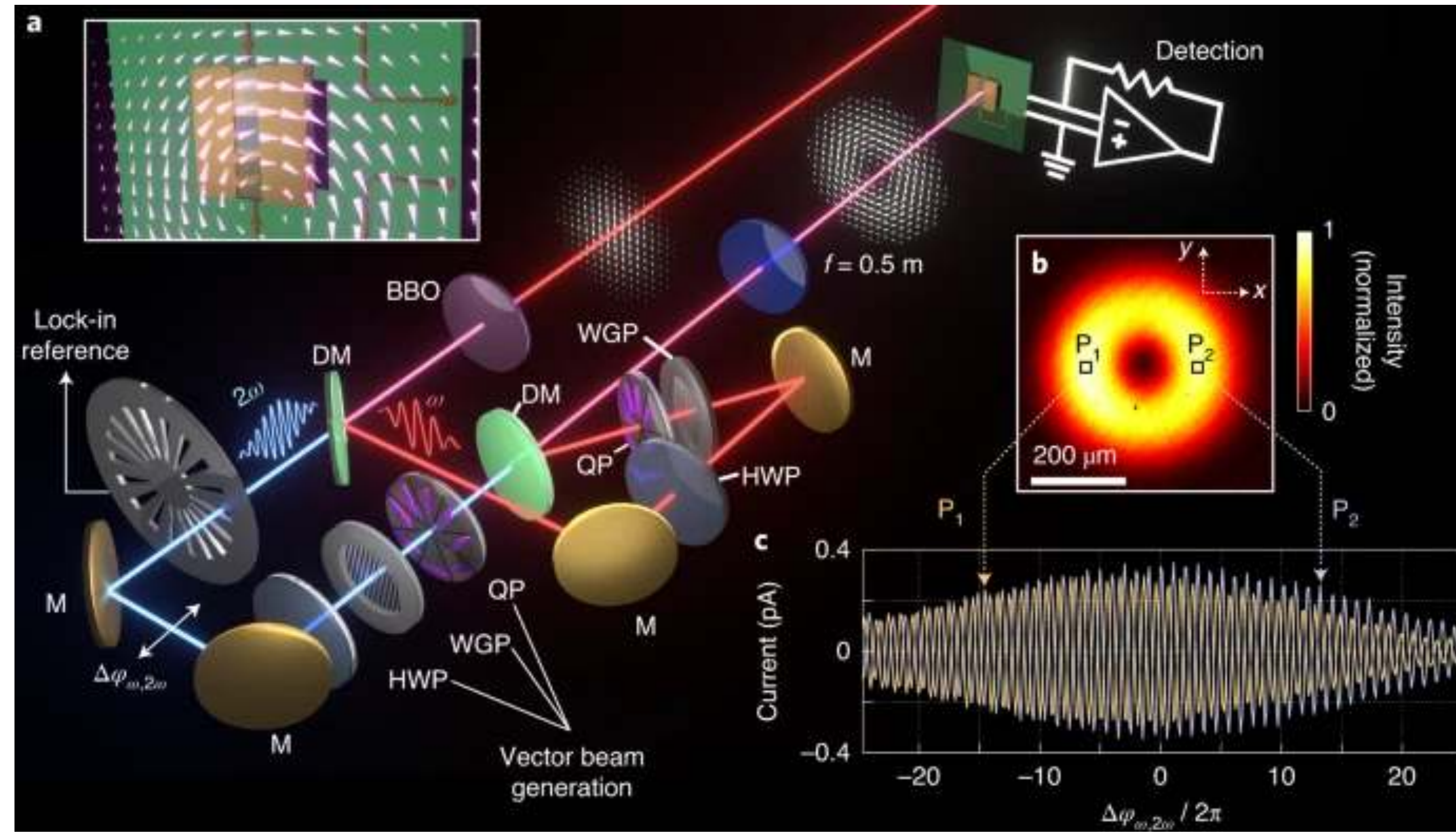
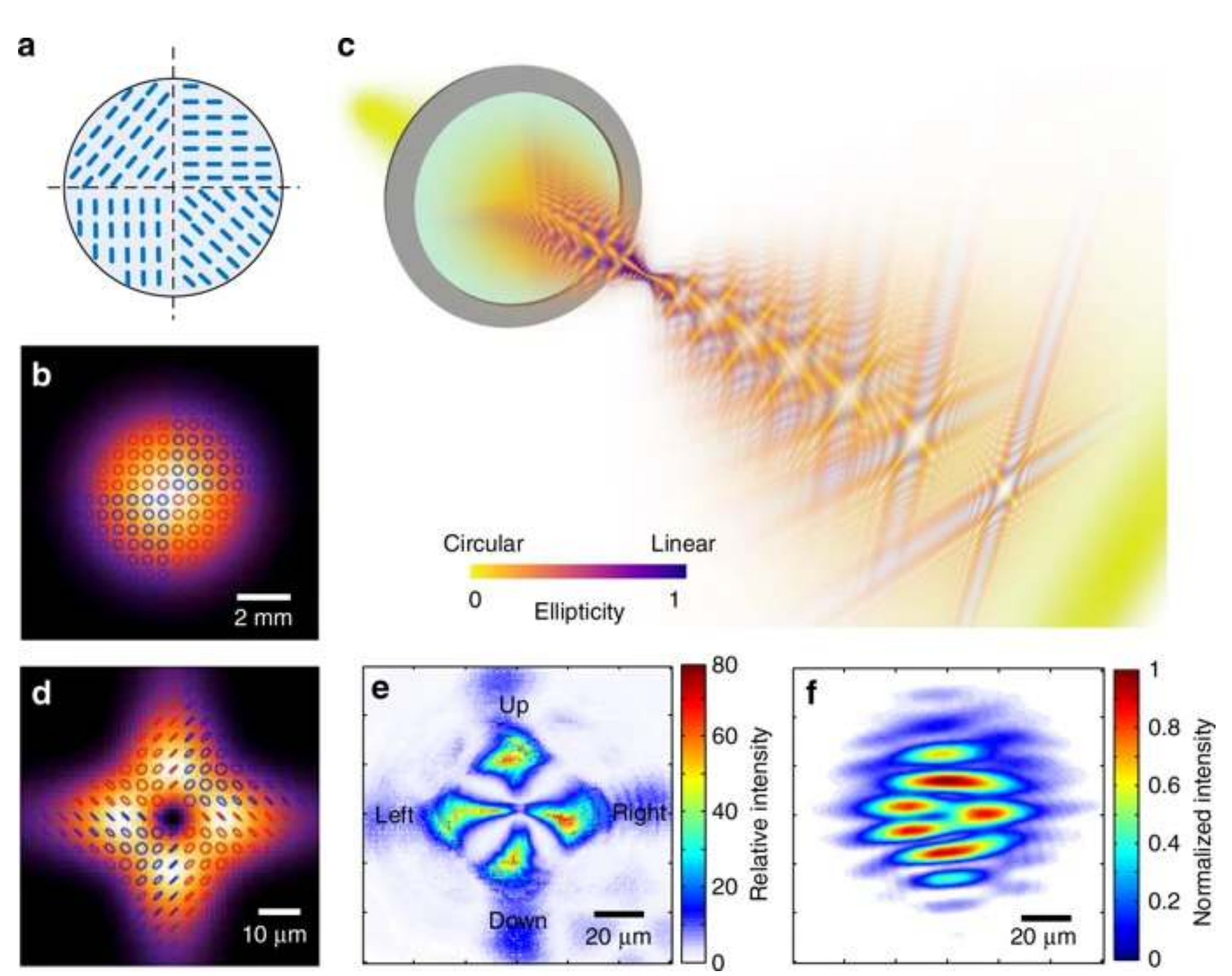

F Kong, C. Zhang, H. Larocque, Z. Li, F. Bouchard, D. H. Ko, G. G. Brown, A. Korobenko, T. J. Hammond, Robert W. Boyd, E. K. & P. B. Corkum, *Nature Communications* **10**, 2020 (2019)
 S Sederberg, F Kong, F Hufnagel, C Zhang, E. K. & P B. Corkum, *Nature Photonics* **14**, 680 (2020).



High-dimensional Entangled States

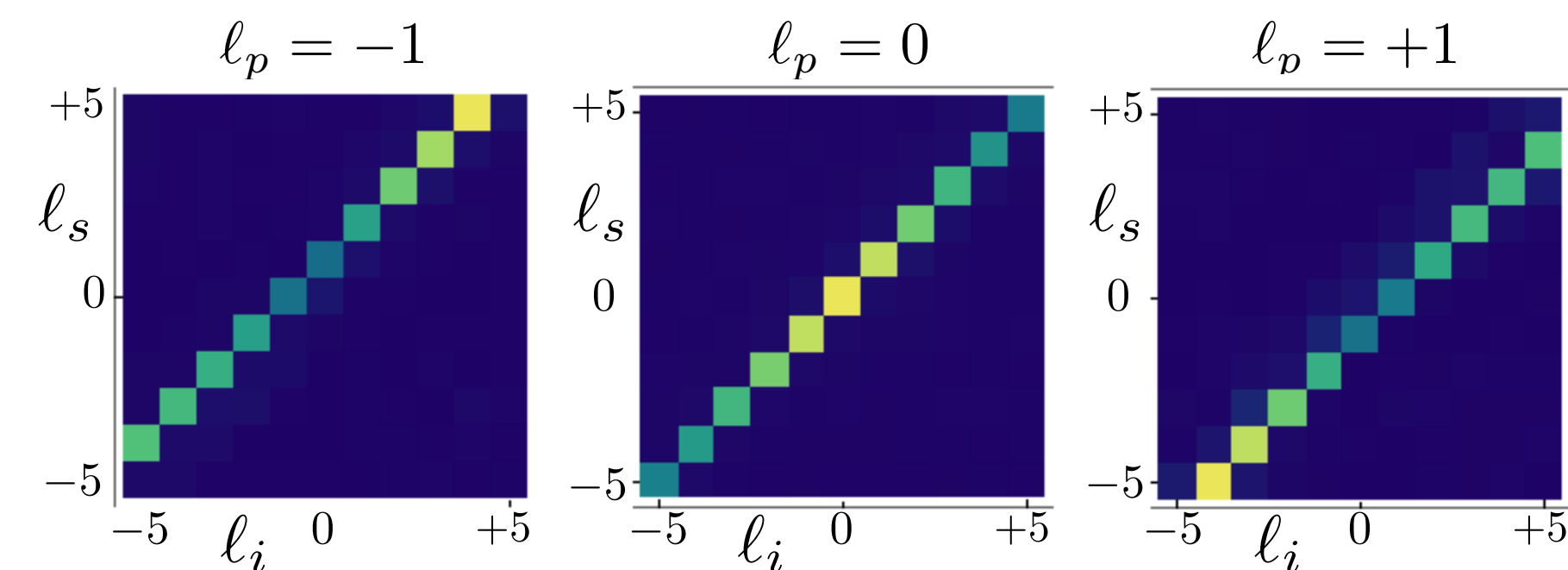
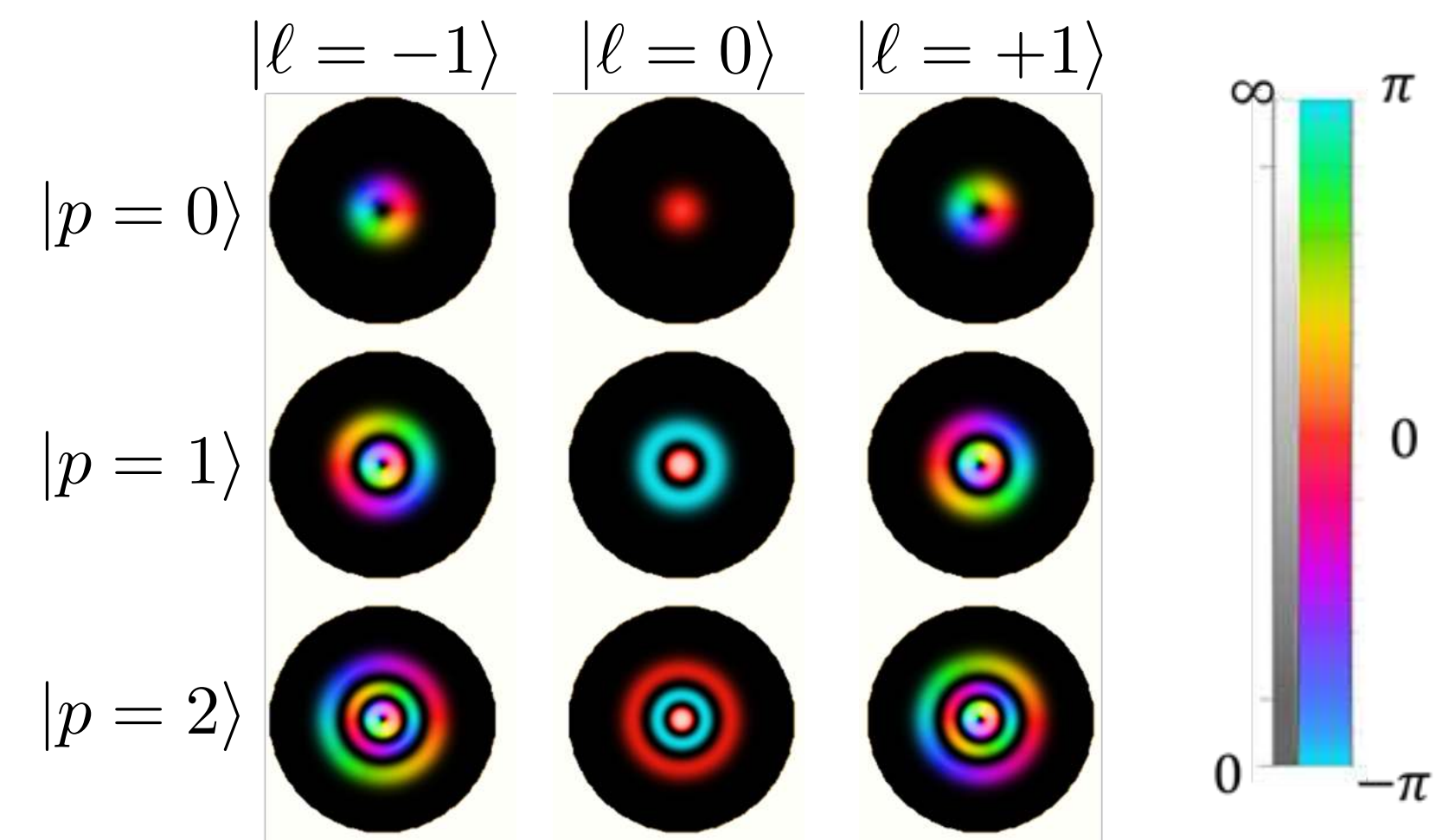
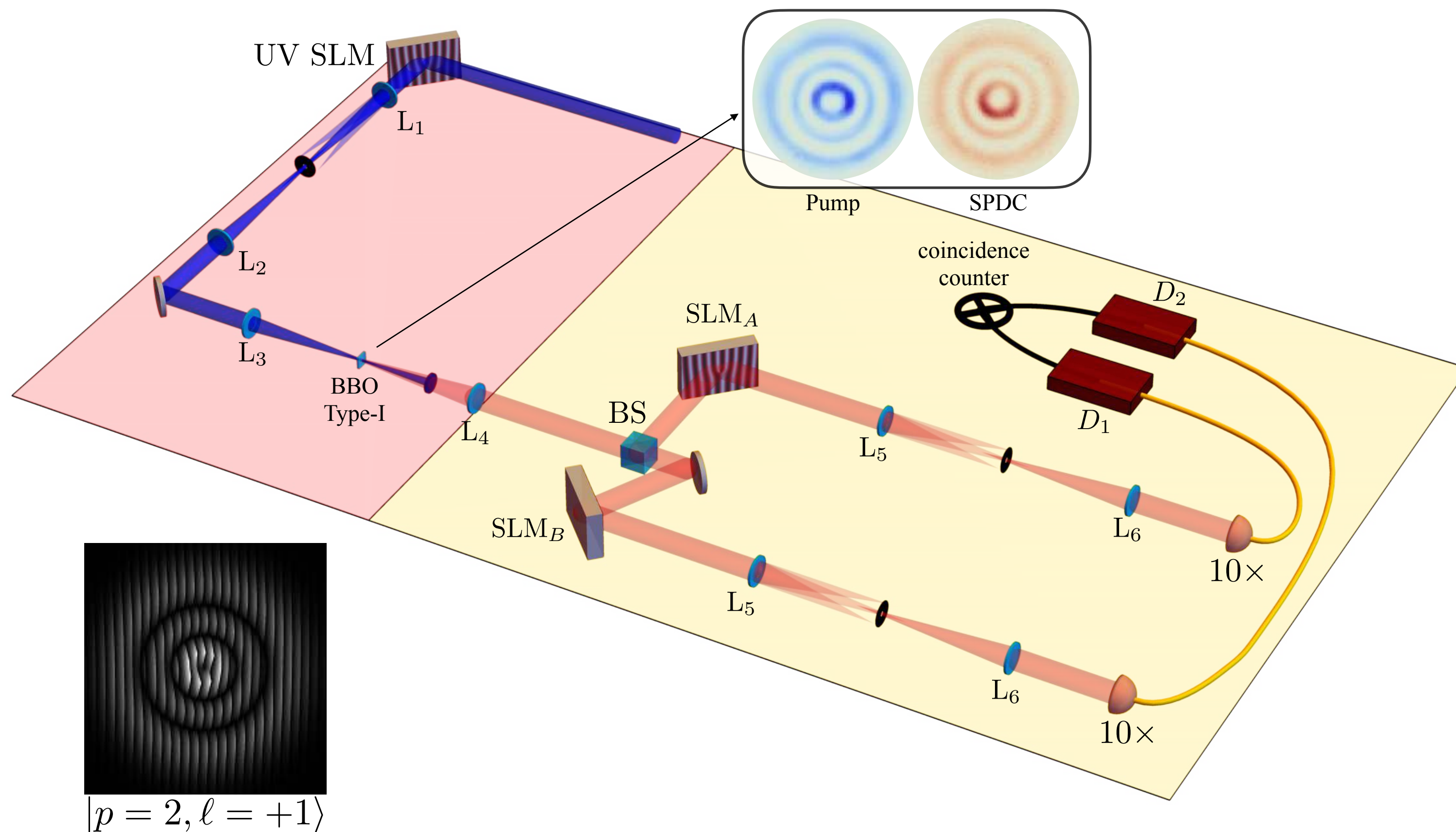

High-dimensional Entangled States

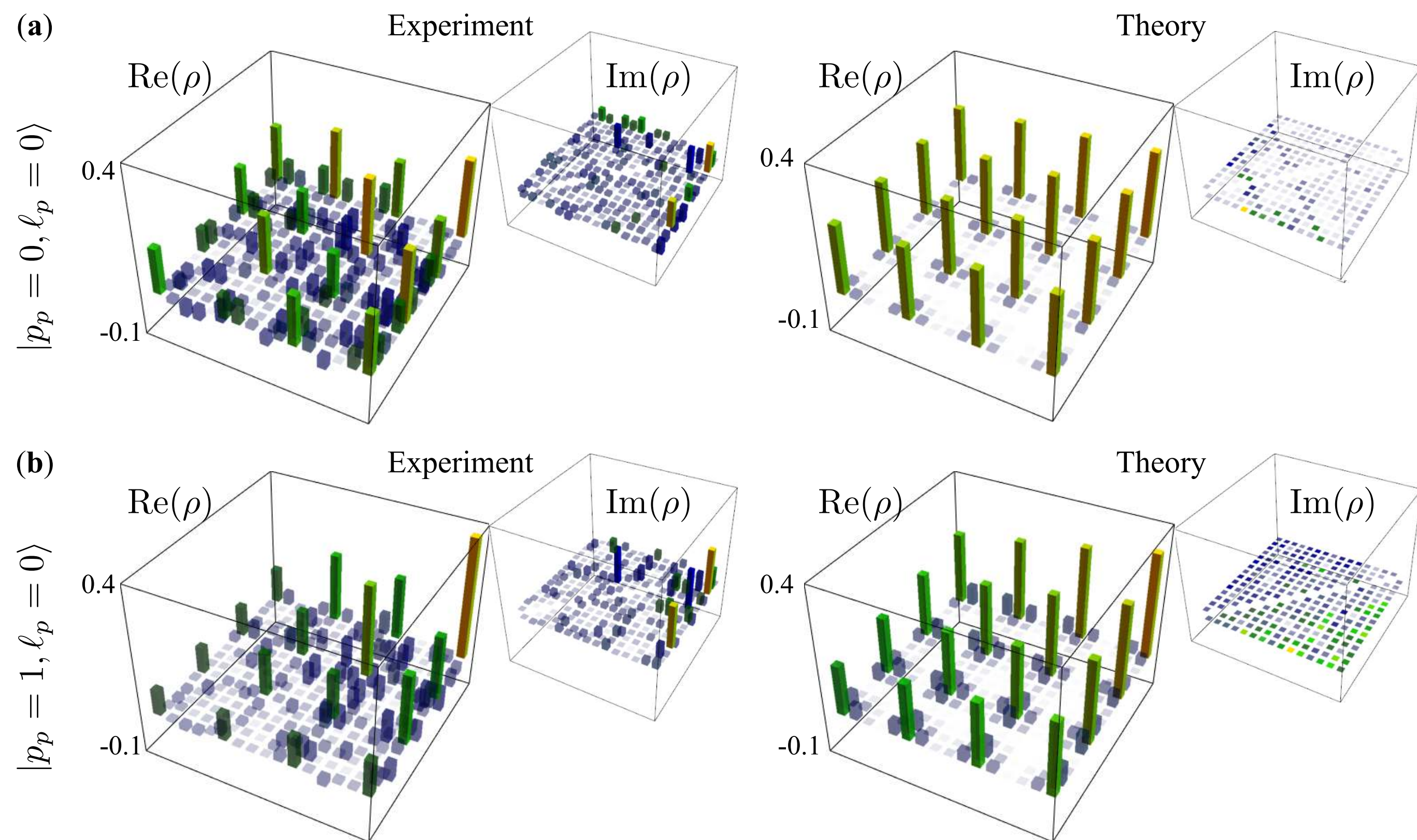
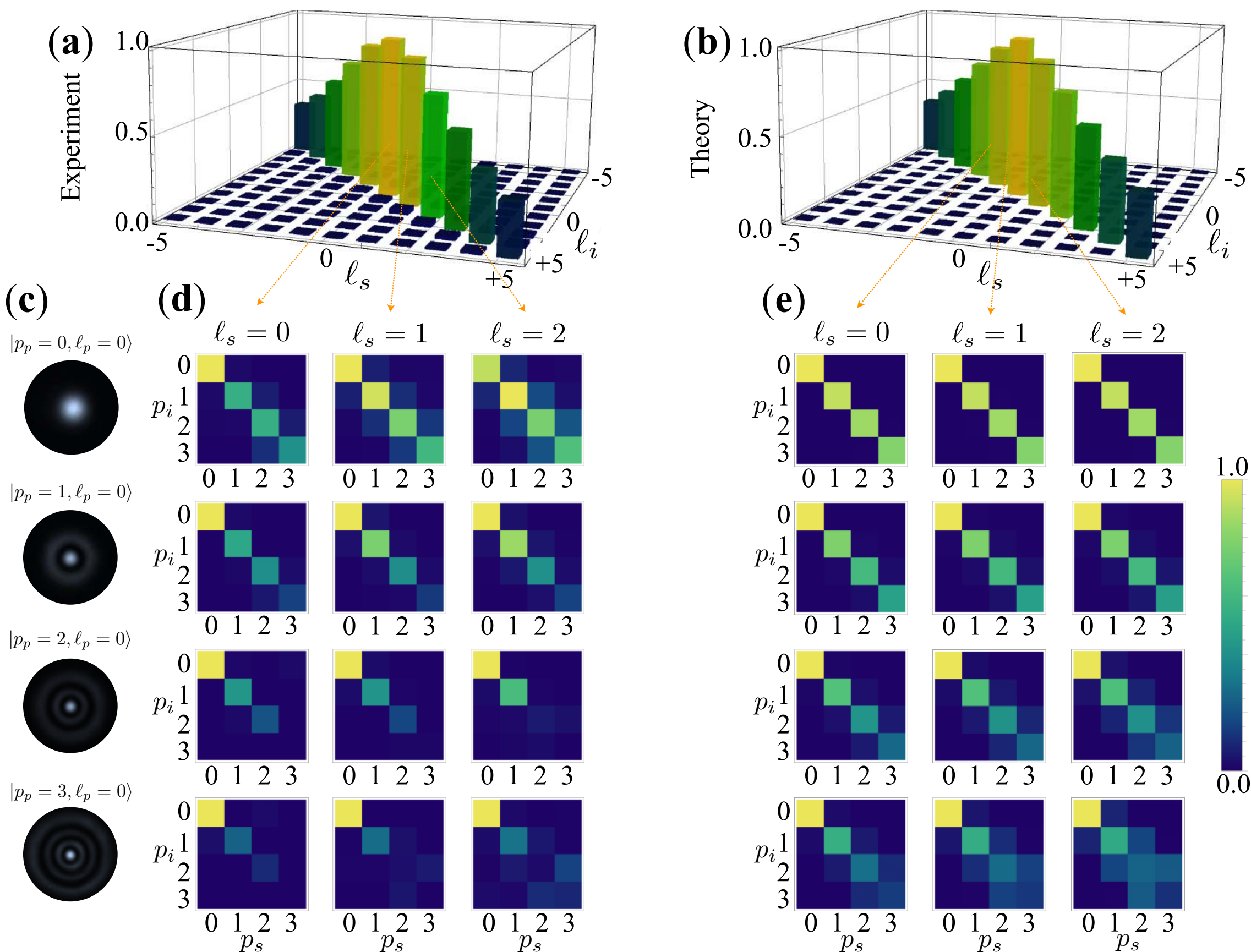

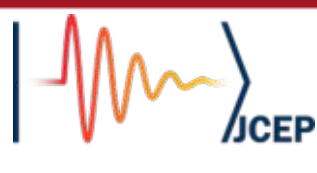

Application in Quantum Communication



Application in High-Dimensional Quantum Key Distribution

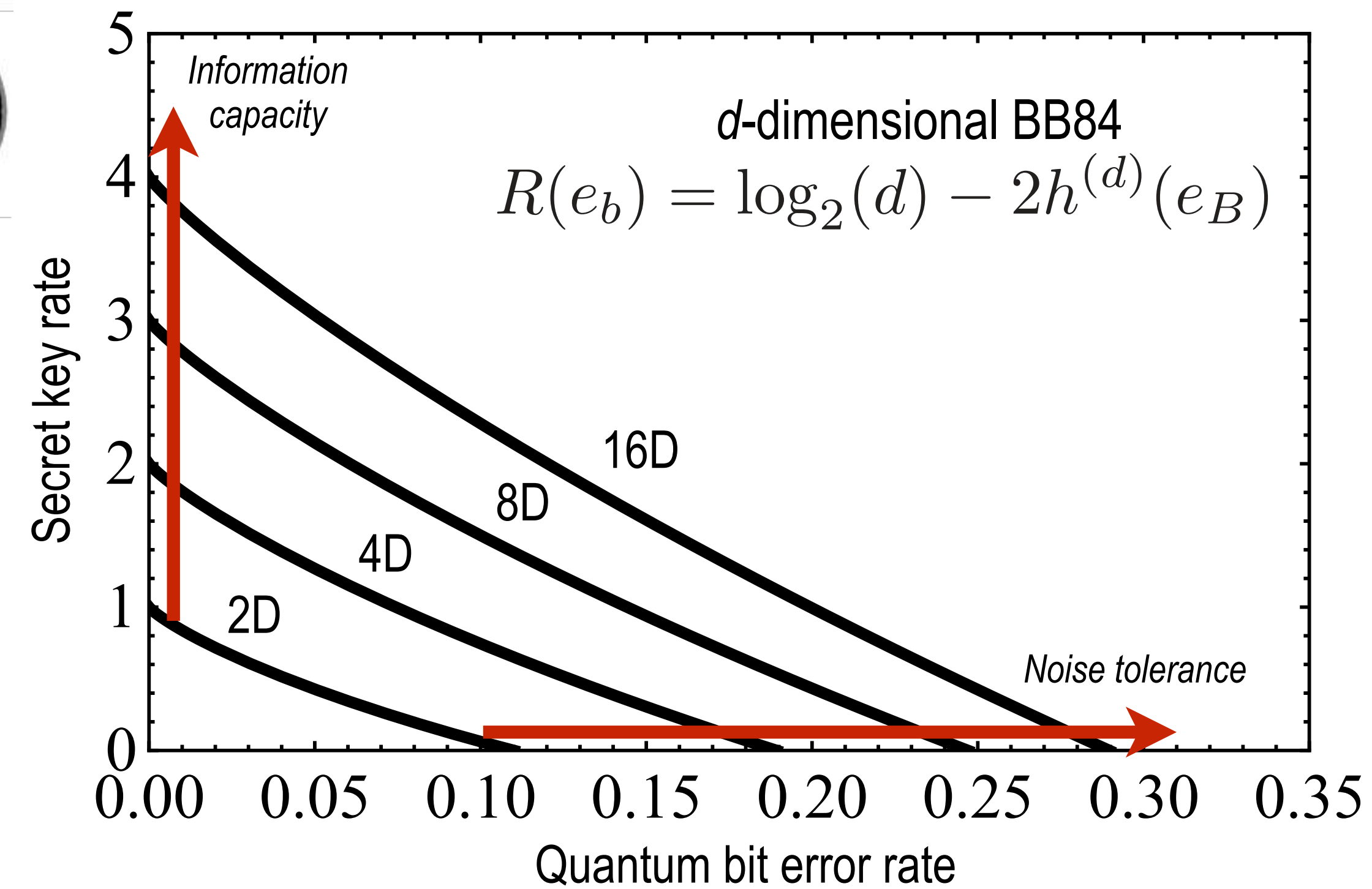
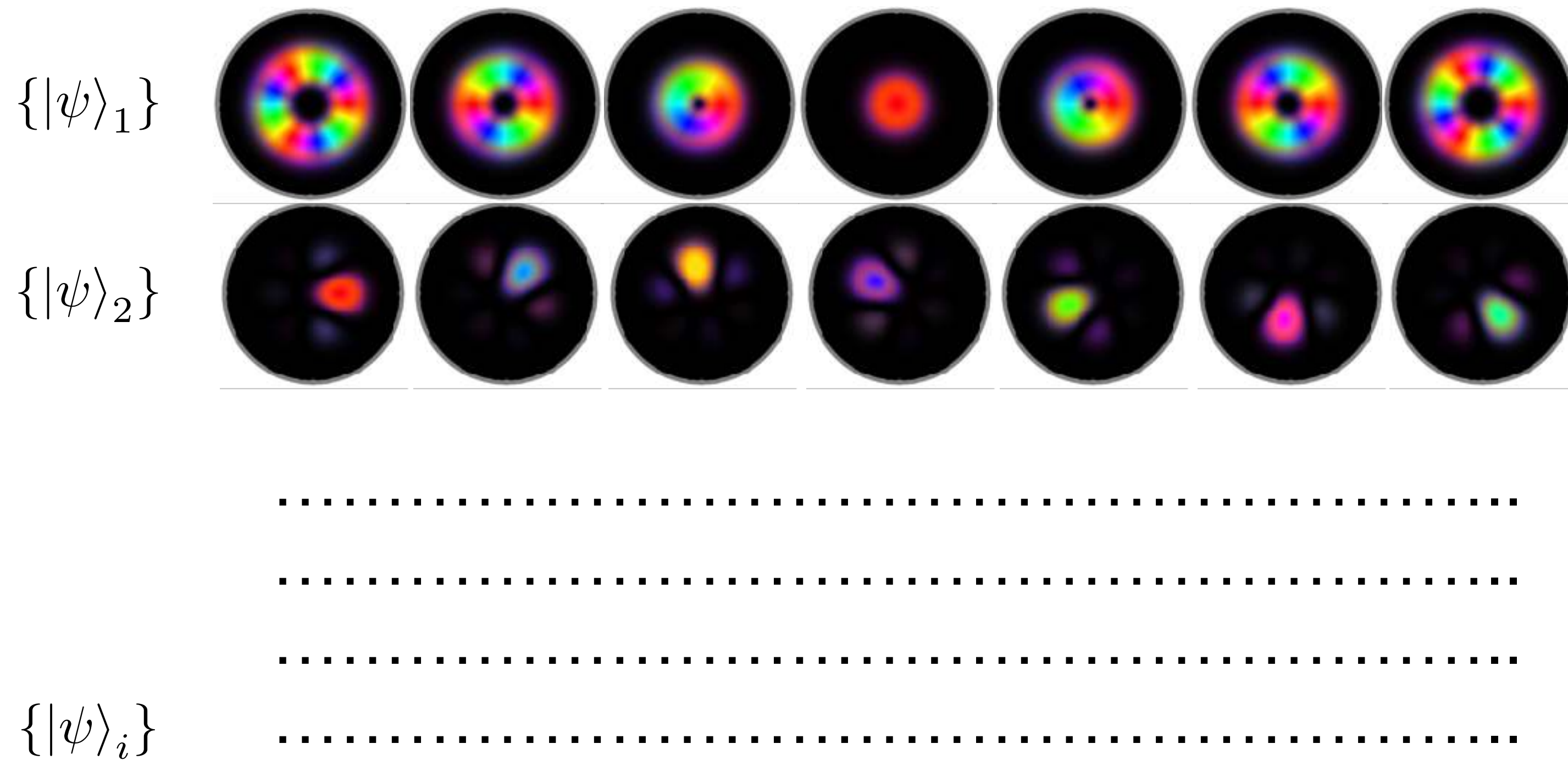

Quantum Key Distribution: Survey and Comparison

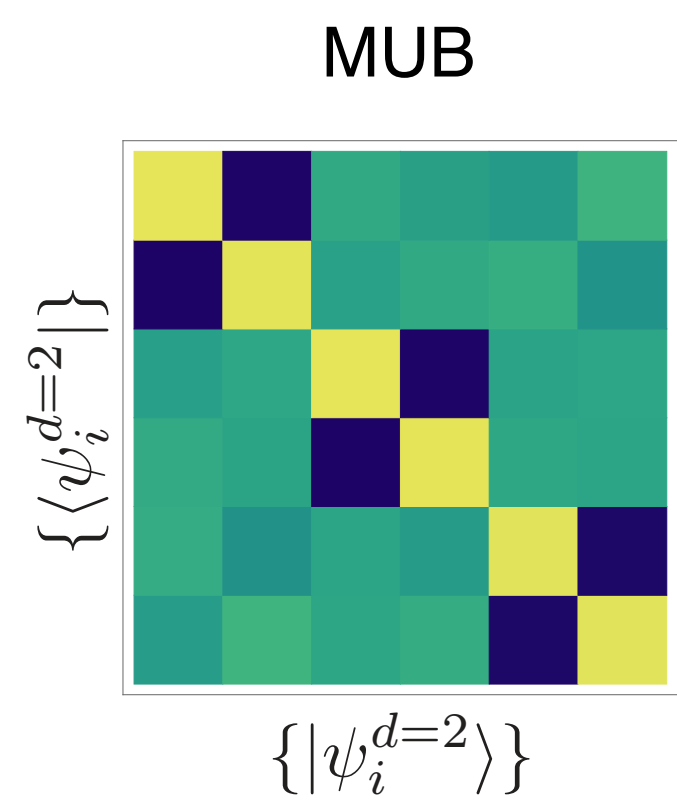
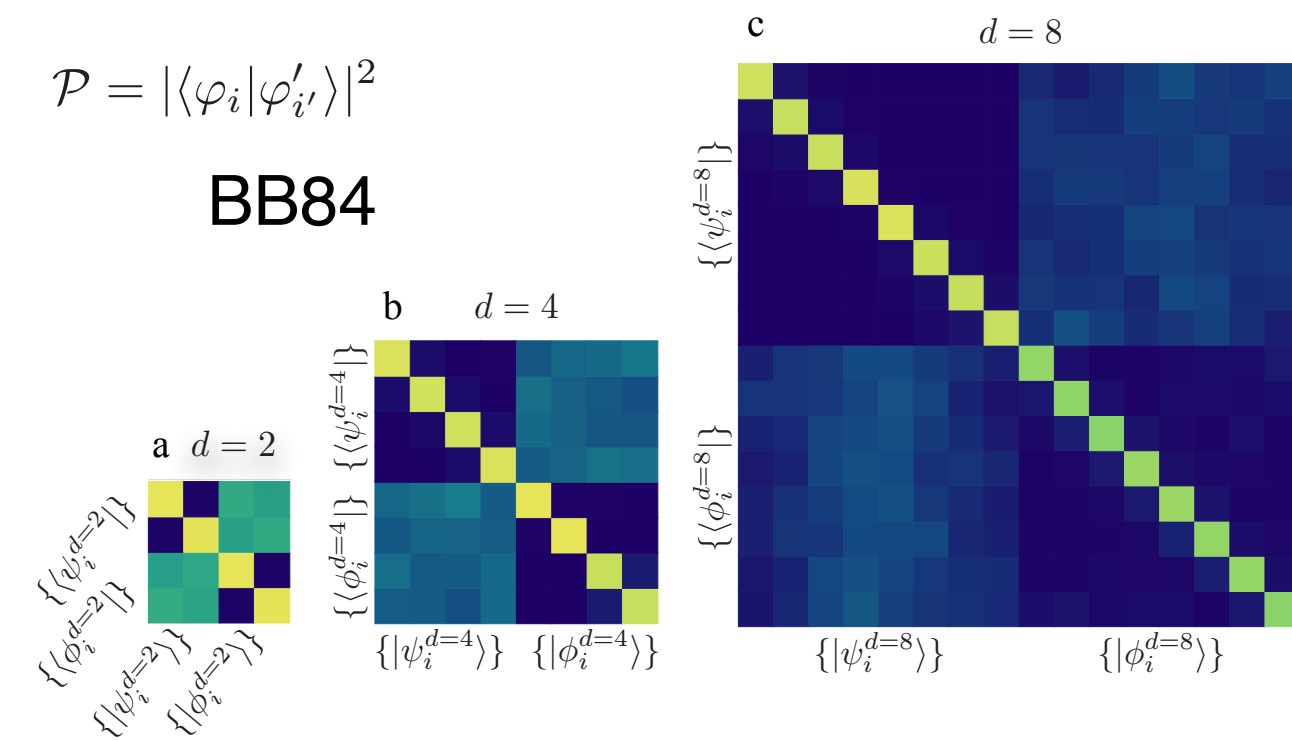
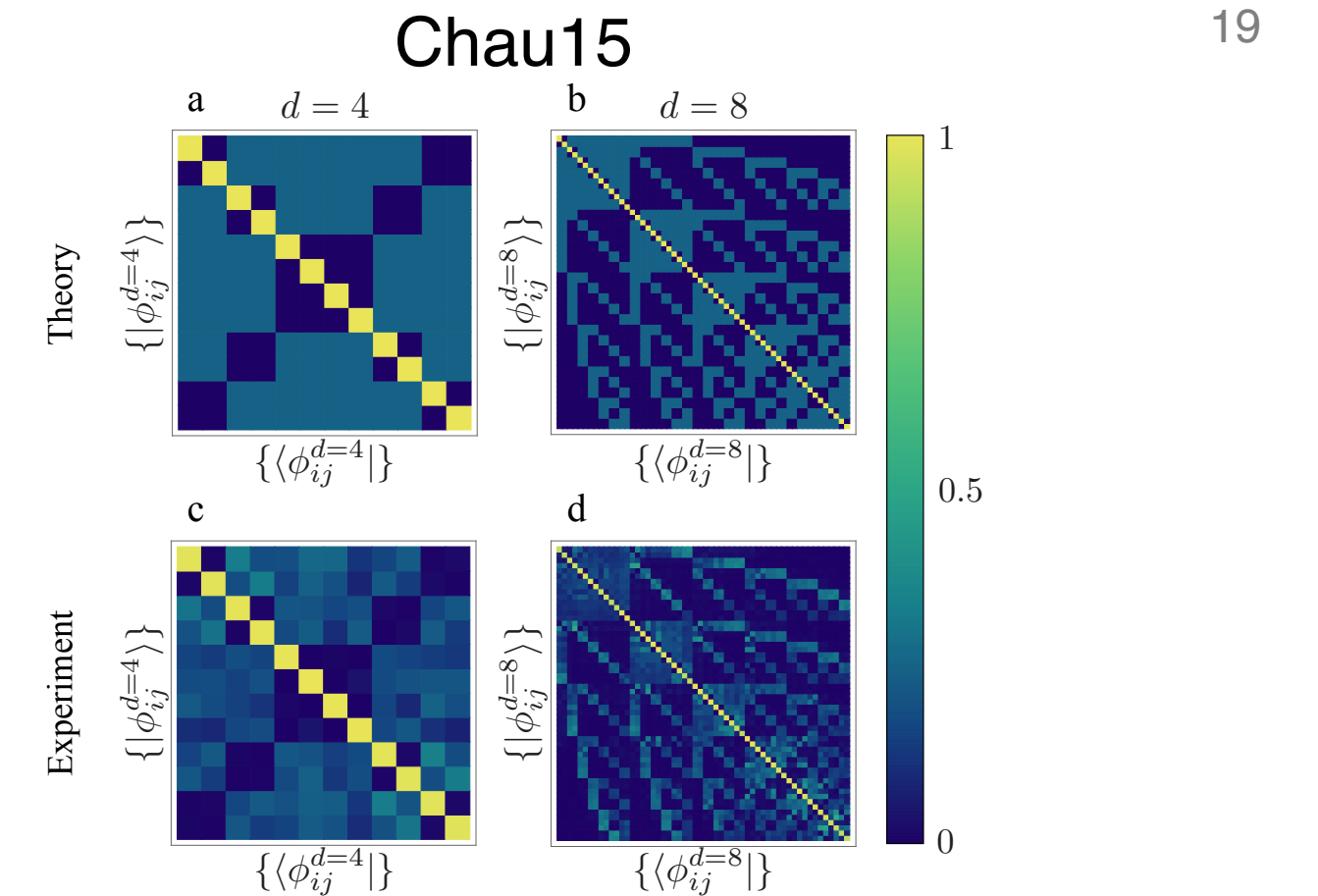
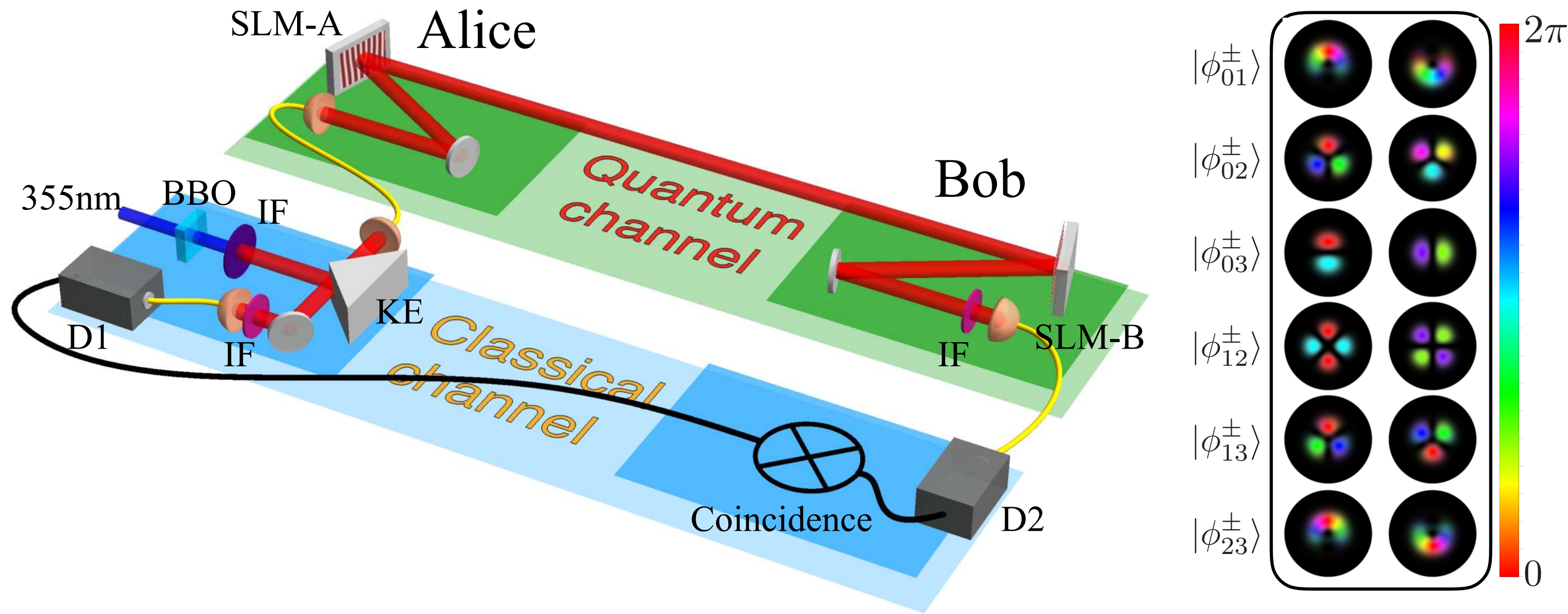

Protocol	d	e_b^{\max}	e_b^{\exp}	$R(0)$	R^{\exp}	Sifting	$R^{\exp} \times \text{Sifting}$
Chau15	4	50 %	0.778 %	1	0.8170	1/6	0.1362
	8	50 %	3.11 %	1	0.8172	1/28	0.0292
BB84	2	11.00 %	0.628 %	1	0.8901	1/2 - 1*	0.4451 - 0.8901
	4	18.93 %	3.51 %	2	1.4500	1/2 - 1*	0.7250 - 1.4500
	8	24.70 %	10.9 %	3	1.3942	1/2 - 1*	0.6971 - 1.3942
MUB	2	12.62 %	0.923 %	1	0.8727	1/3 - 1*	0.2909 - 0.8727
	4	23.17 %	3.87 %	2	1.5316	1/5 - 1*	0.3063 - 1.5316
Singapore	2	38.93 %	1.23 %	0.4	0.374**	1	0.374**



High-Dimensional Quantum Key Distribution: Security threshold

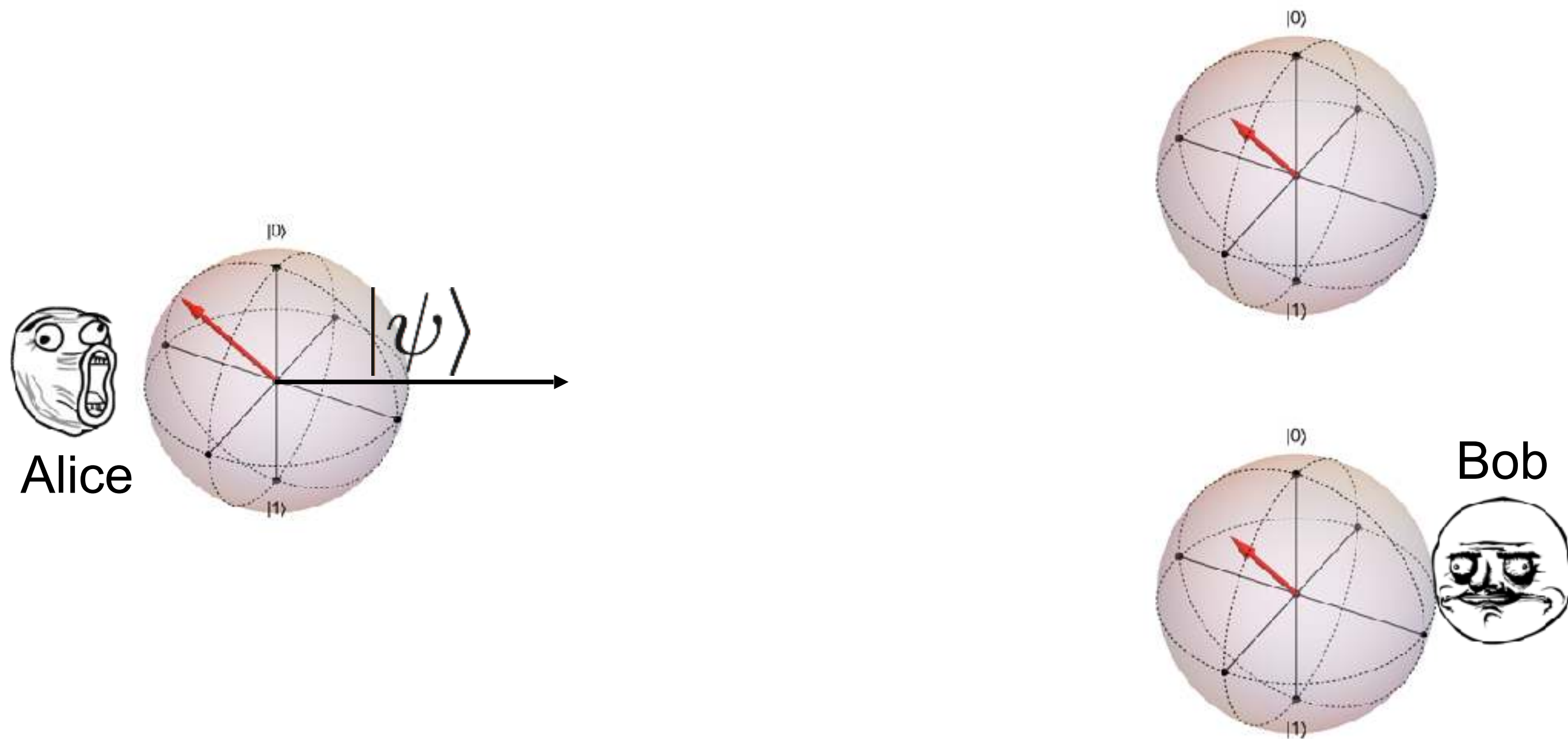

High-Dimensional Quantum Key Distribution: Security threshold

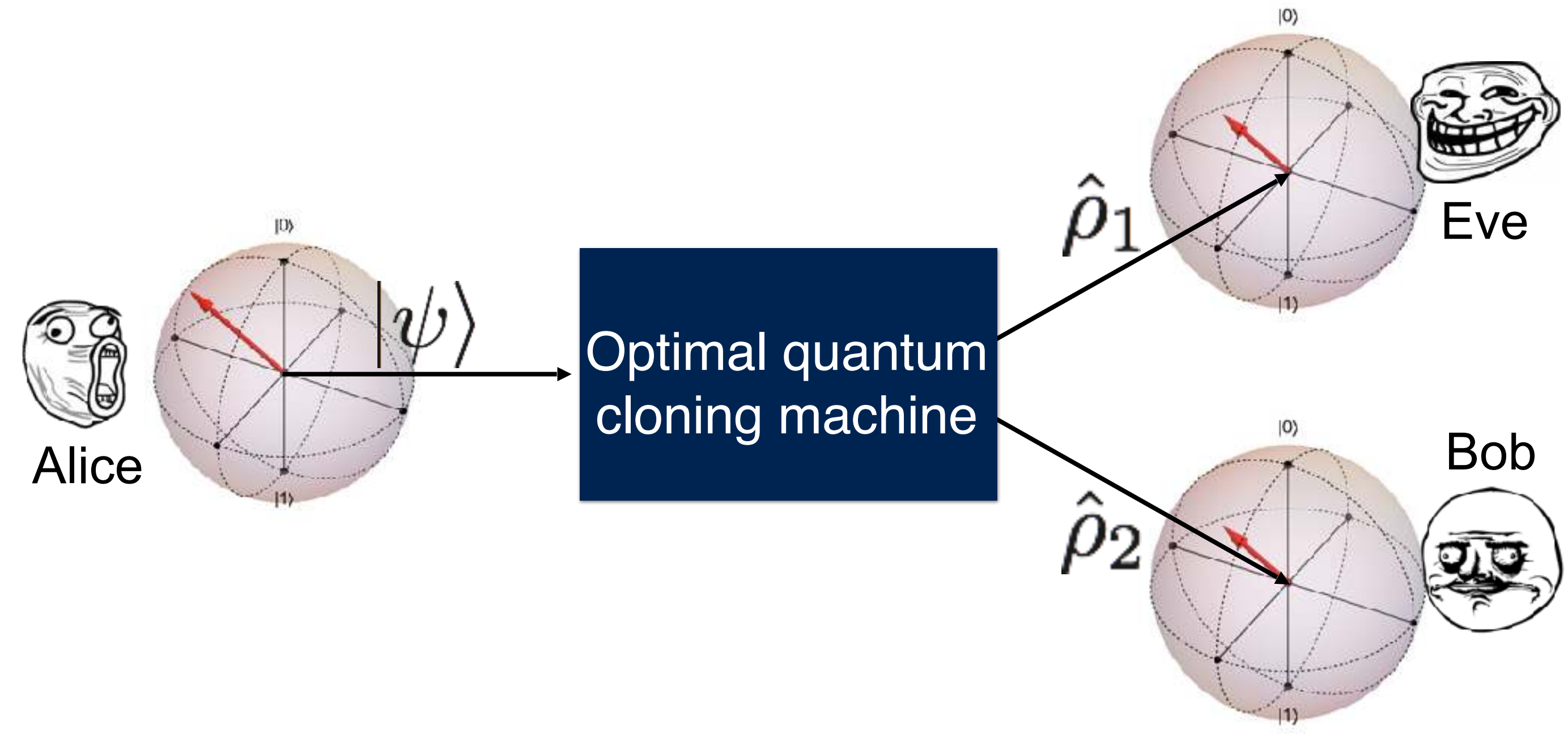

High-Dimensional Quantum Key Distribution: Security threshold

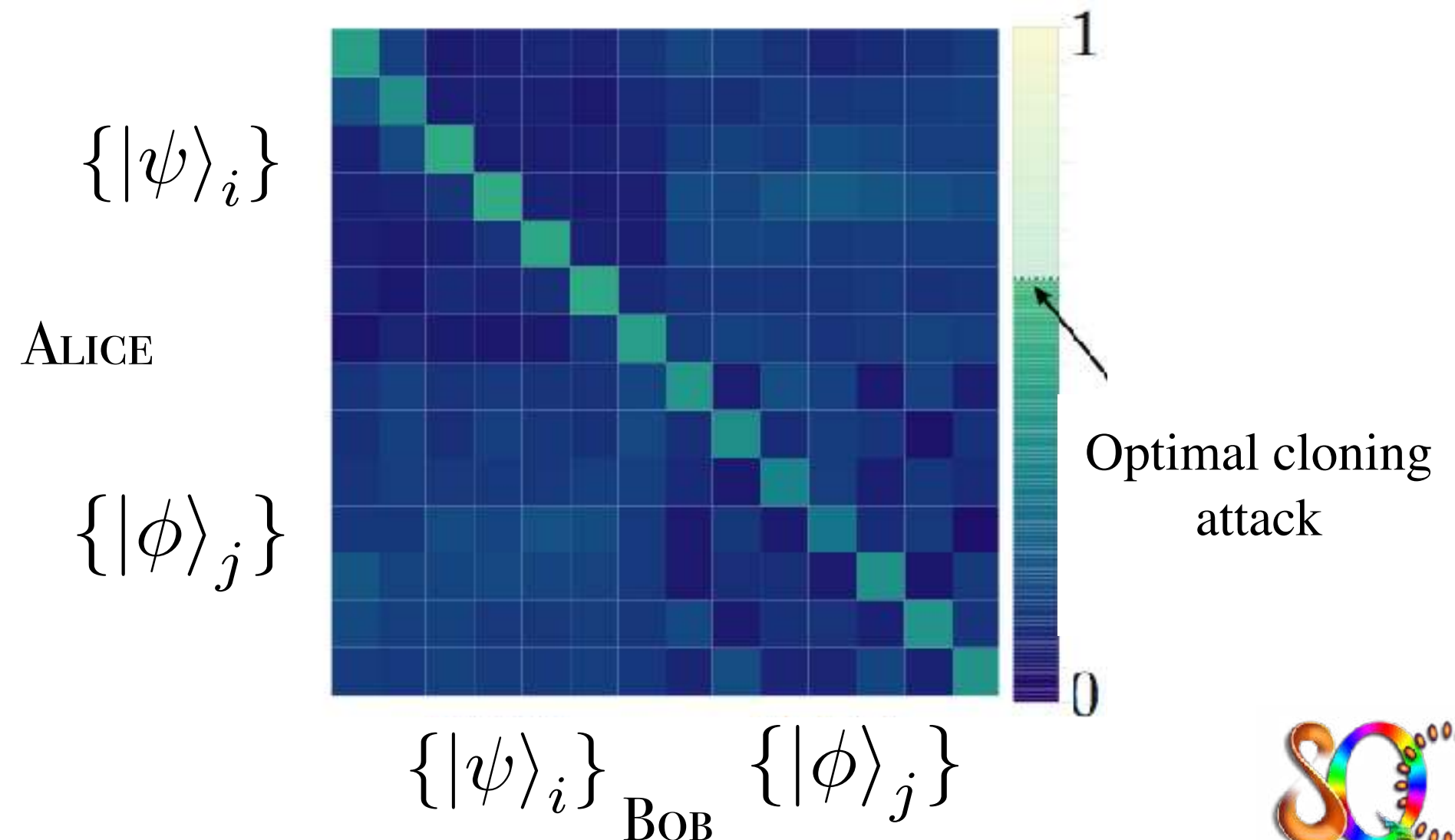
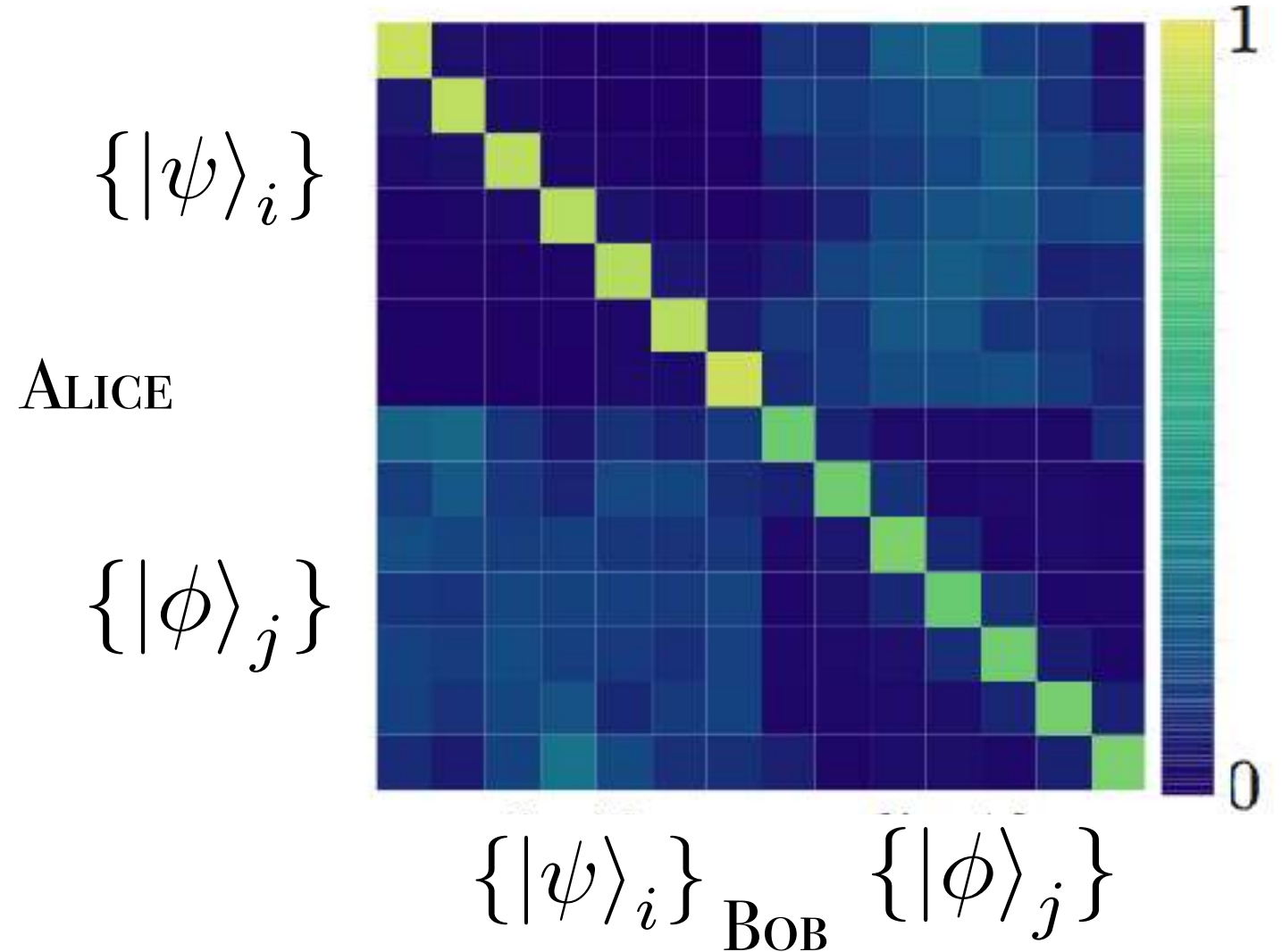
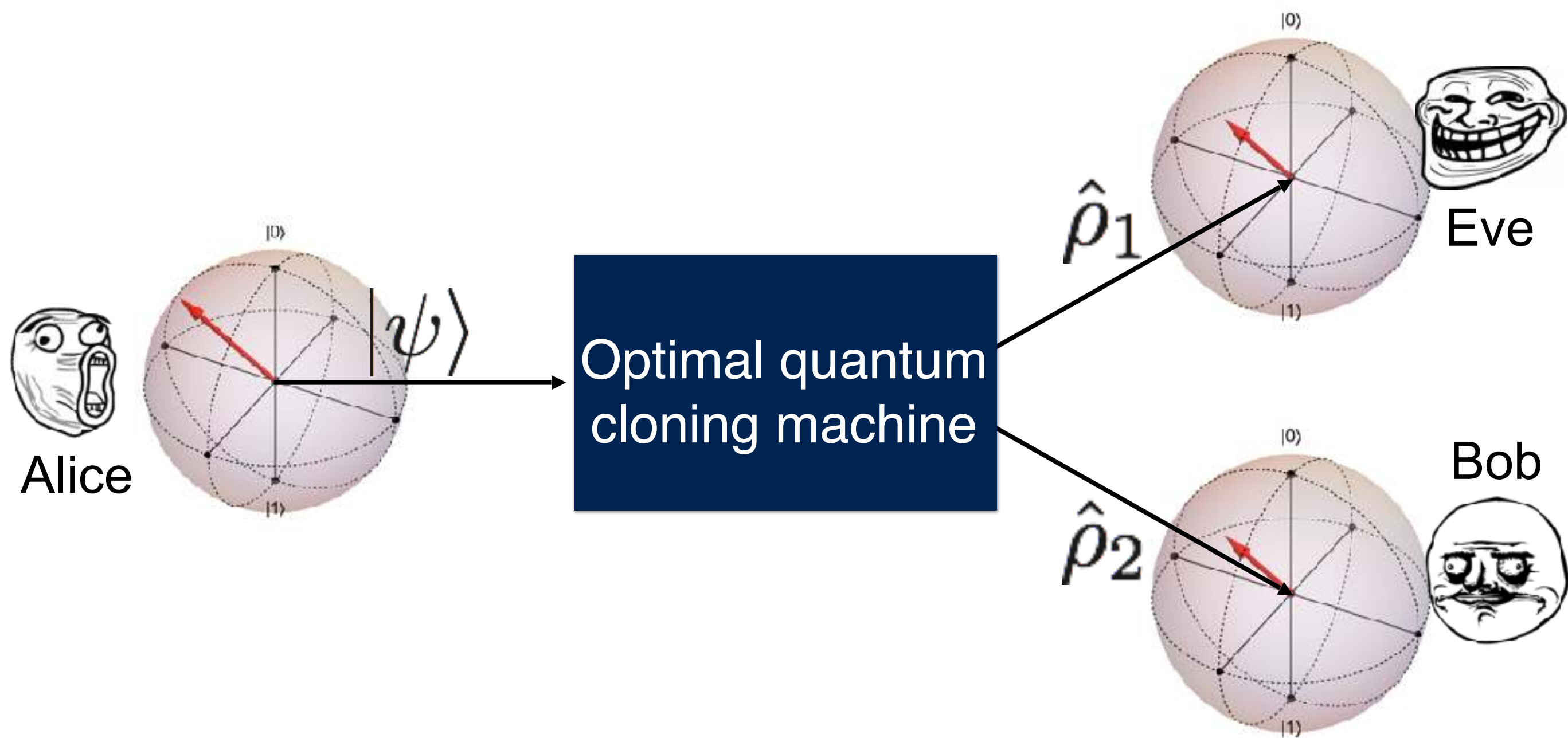

High-Dimensional Quantum Key Distribution: Security threshold

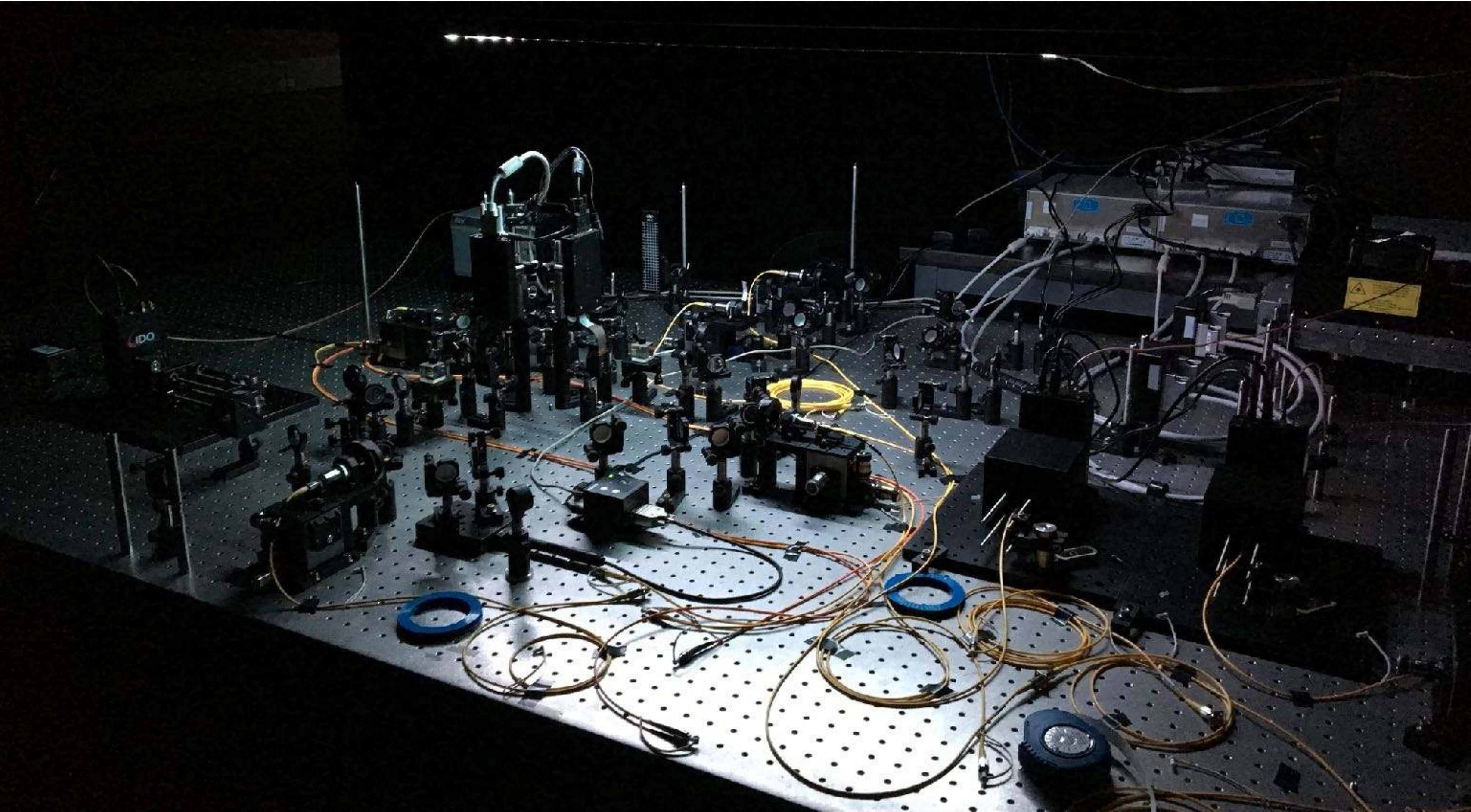

Alice

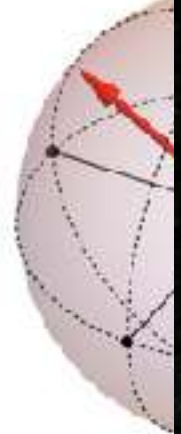

Optimal cloning attack



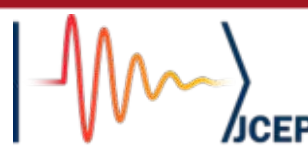

High-Dimensional Quantum Key Distribution: Security threshold

Dimension	$d = 2$	$d = 3$	$d = 4$	$d = 5$	$d = 6$	$d = 7$	$d \rightarrow \infty$
Theory	0.833	0.75	0.7	0.667	0.643	0.625	0.5
Experimental	0.82 ± 0.01	0.75 ± 0.01	0.70 ± 0.02	0.66 ± 0.01	0.64 ± 0.02	0.62 ± 0.02	
	0.84 ± 0.02	0.75 ± 0.01	0.70 ± 0.01	0.67 ± 0.01	0.62 ± 0.01	0.61 ± 0.01	
		0.75 ± 0.01	0.68 ± 0.01	0.65 ± 0.08	0.62 ± 0.01	0.61 ± 0.01	
			0.70 ± 0.02	0.66 ± 0.01	0.62 ± 0.01	0.60 ± 0.01	
				0.65 ± 0.02	0.62 ± 0.01	0.61 ± 0.01	
Average	0.83 ± 0.02	0.75 ± 0.01	0.70 ± 0.02	0.66 ± 0.01	0.63 ± 0.02	0.61 ± 0.01	

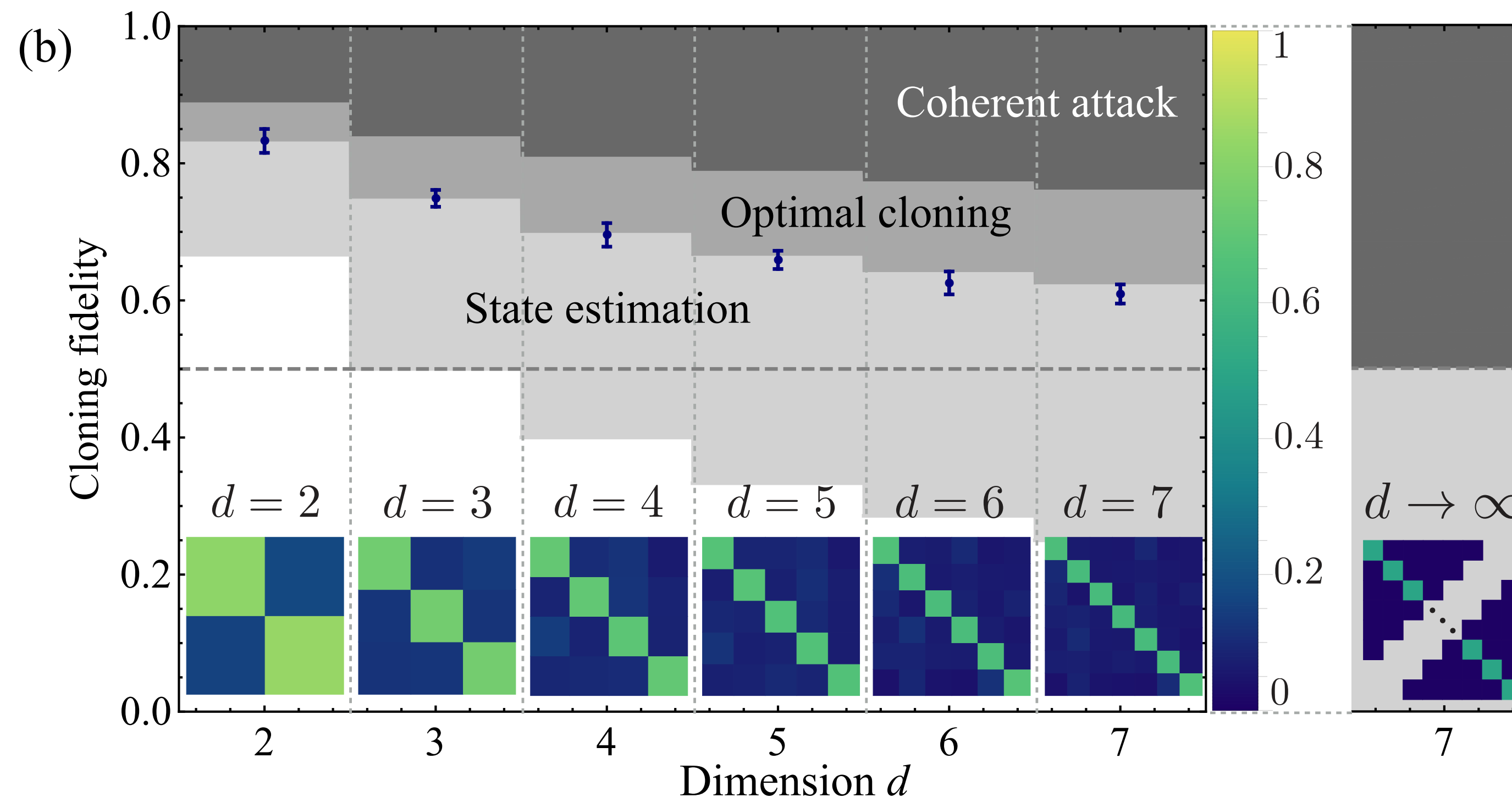

Quantum Key Distribution: Process Matrix and Detecting Eavesdropper

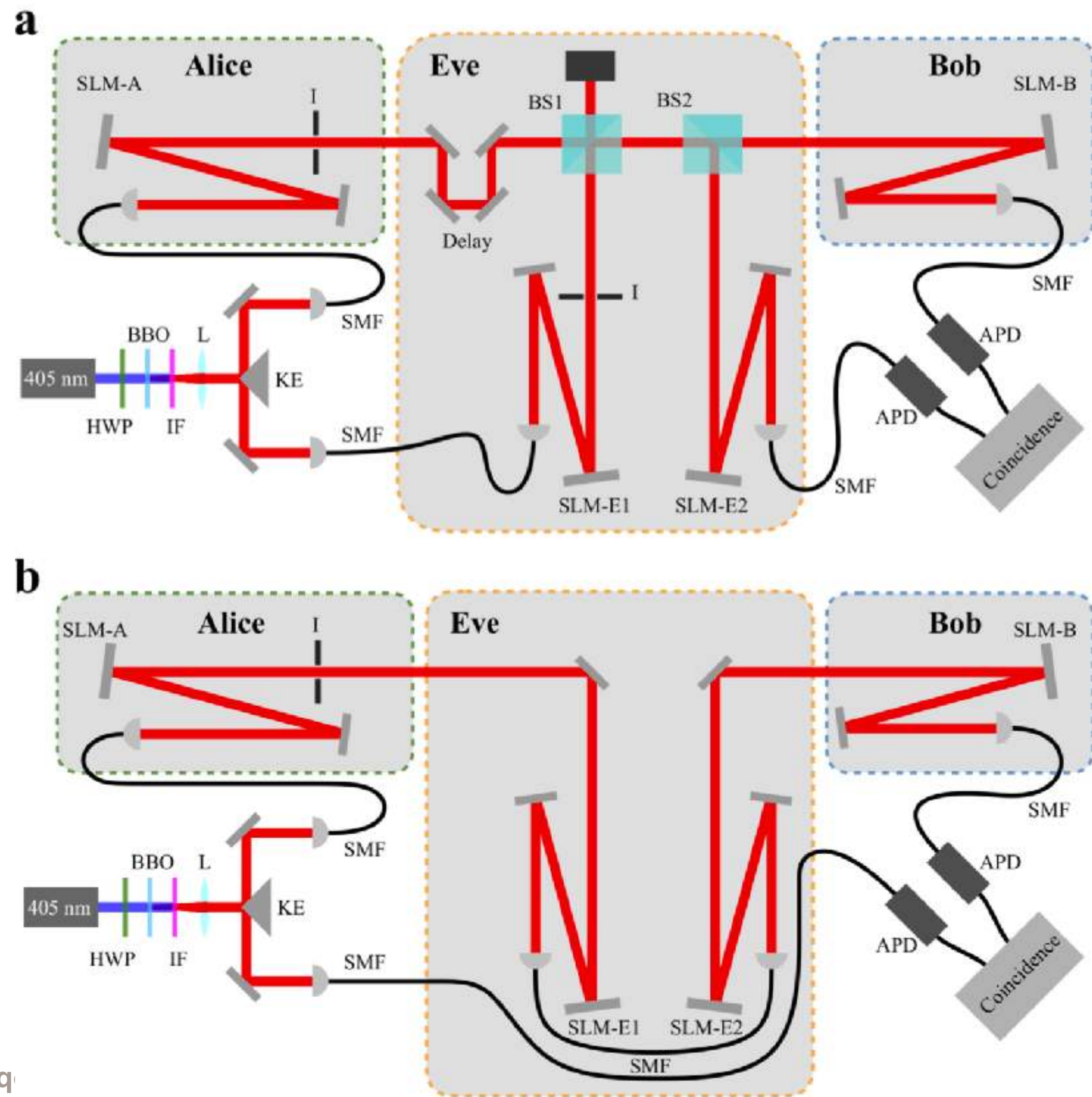

No attack

Optimal cloning

Intercept-resend

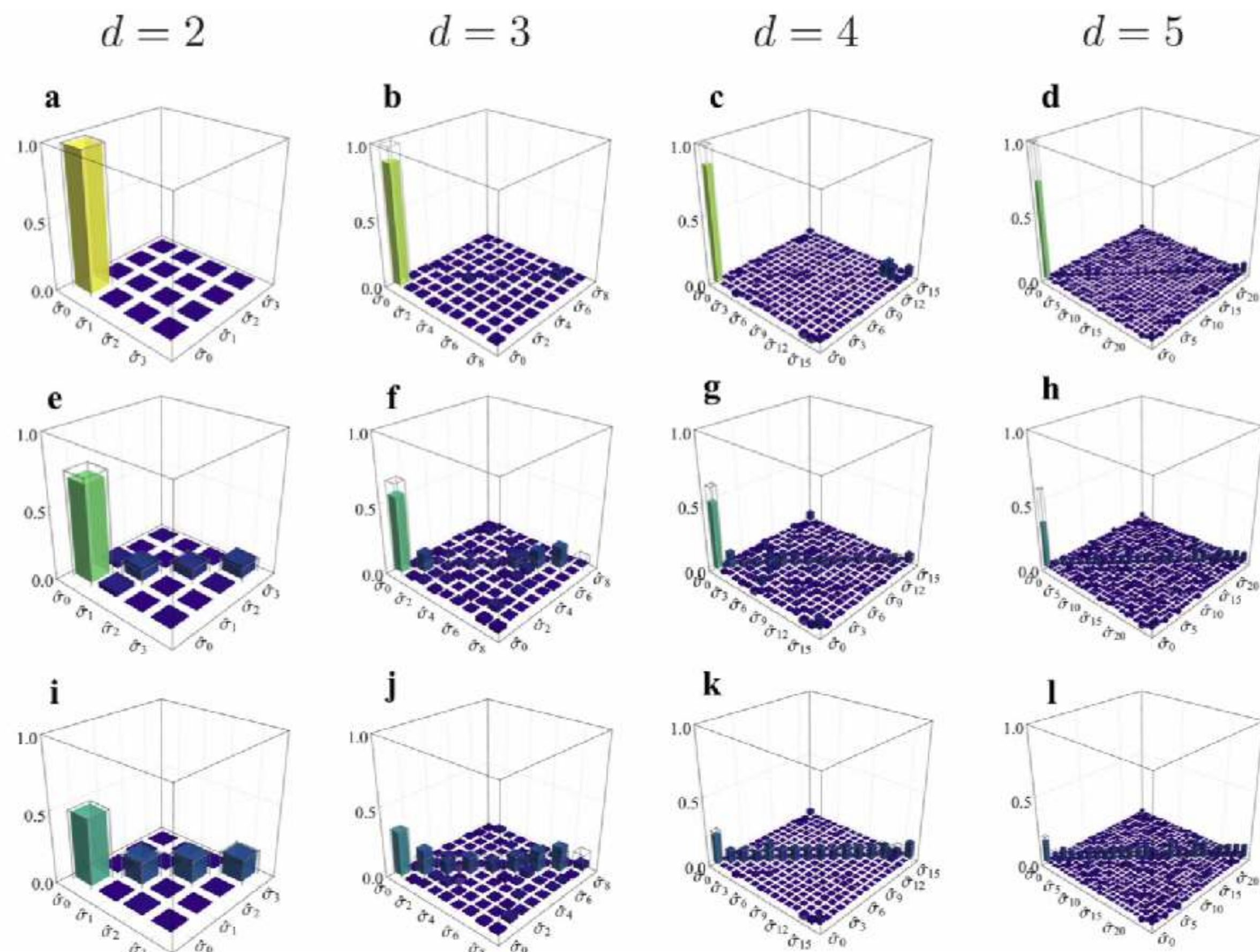

Structured Photons: Applications in Secure Communication

Structured Photons:

More information per carrier

They are robust in a noisier channel

$\{|\psi\rangle_i\}$

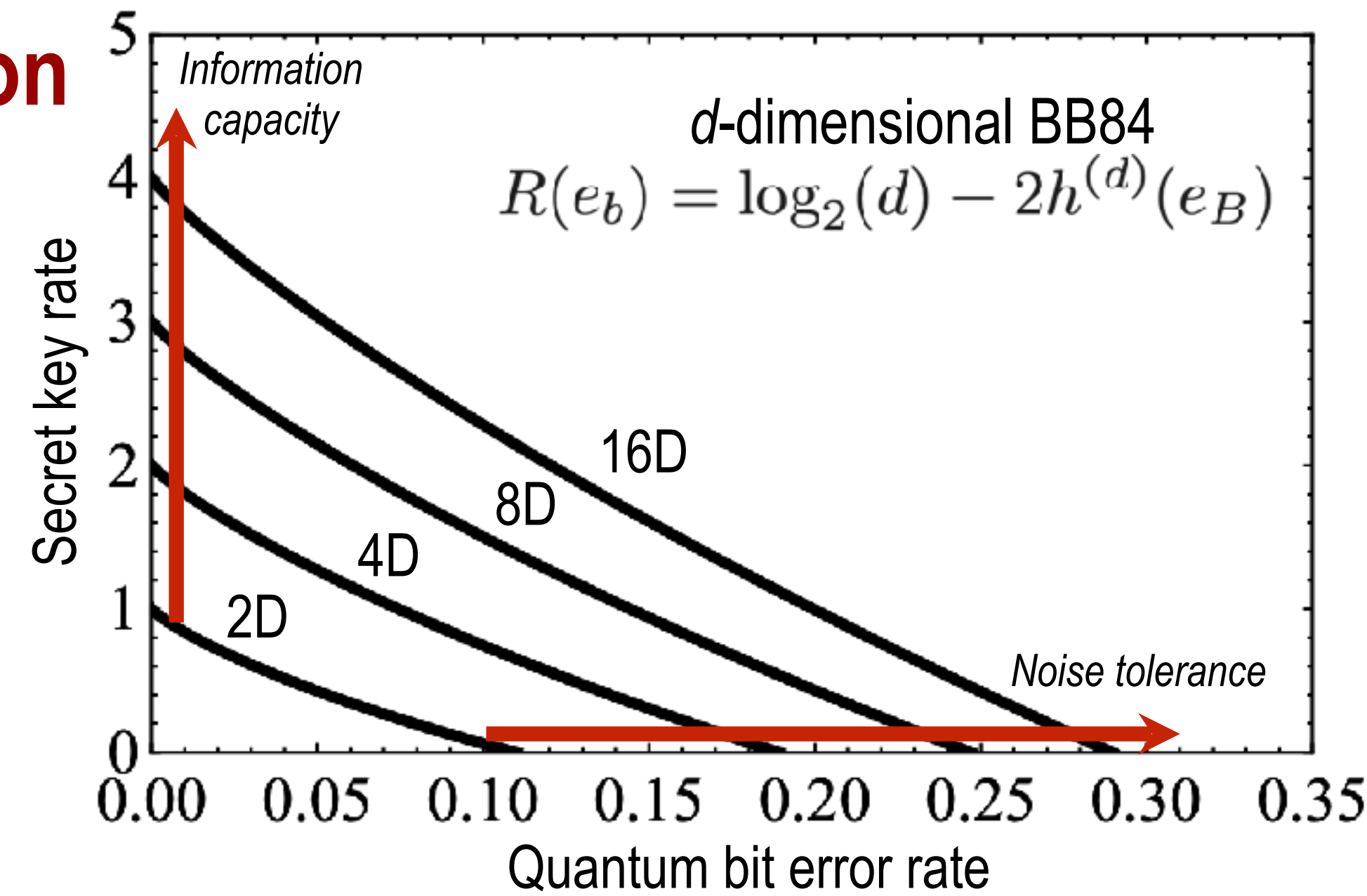
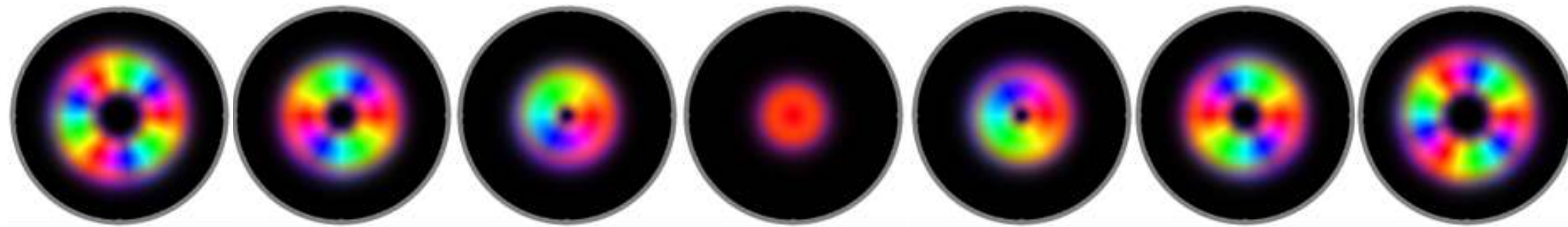

Structured Photons: Applications in Secure Communication

Structured Photons:

- More information per carrier
- They are robust in a noisier channel

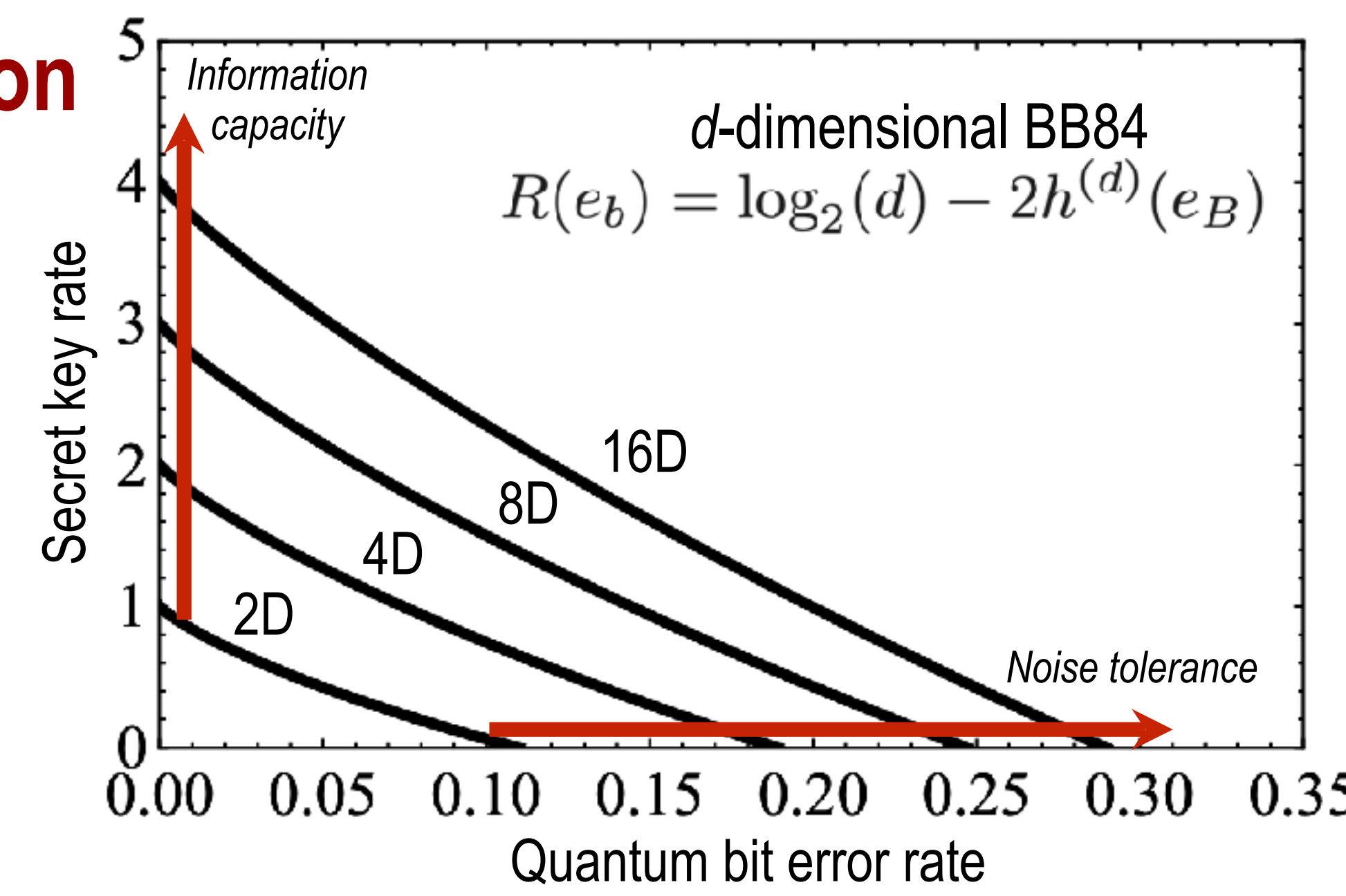
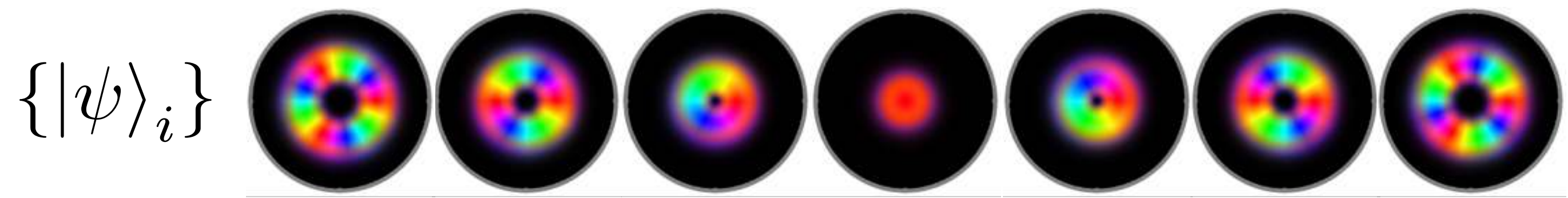

Free-space channel

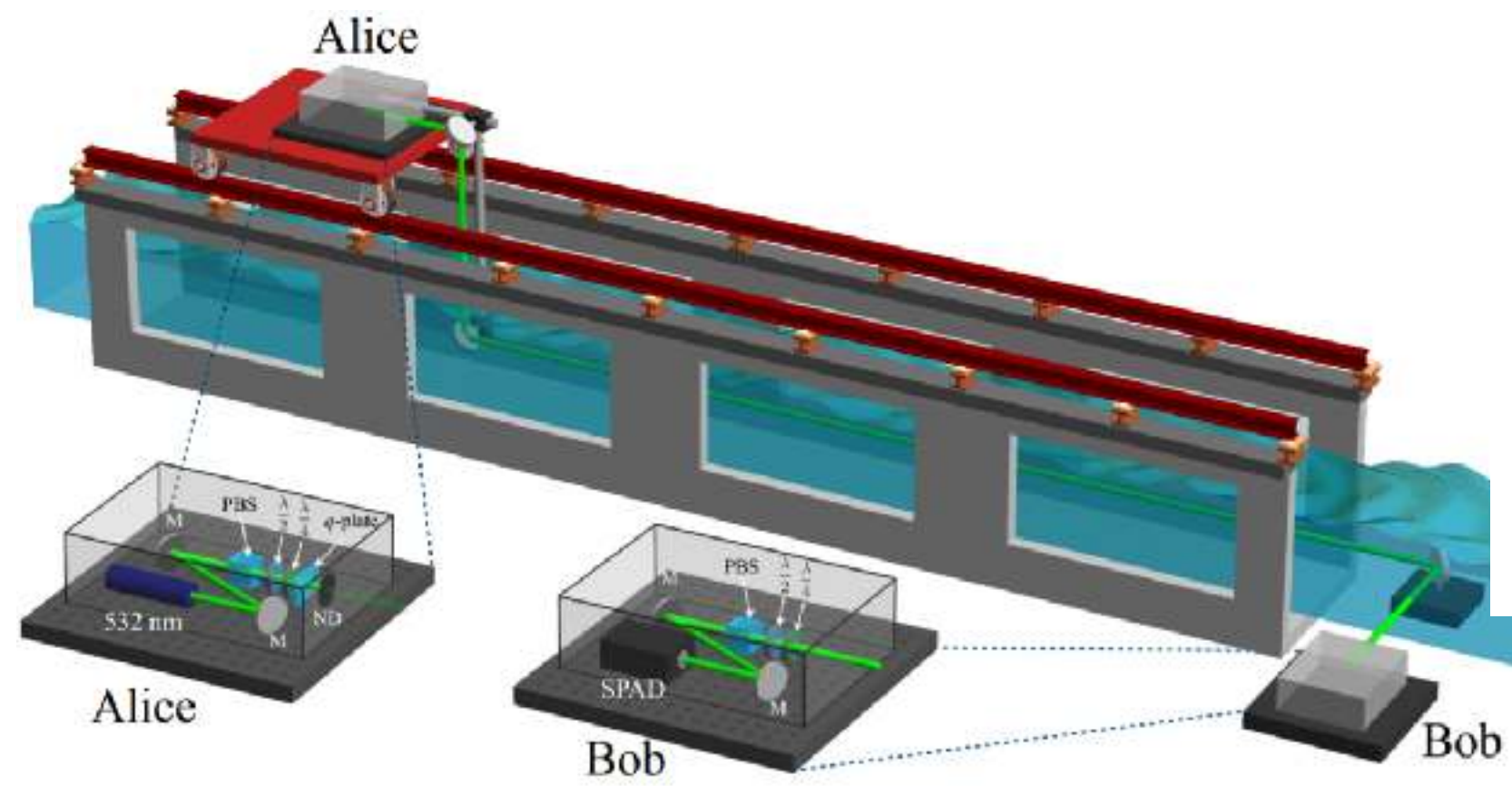

Underwater channel

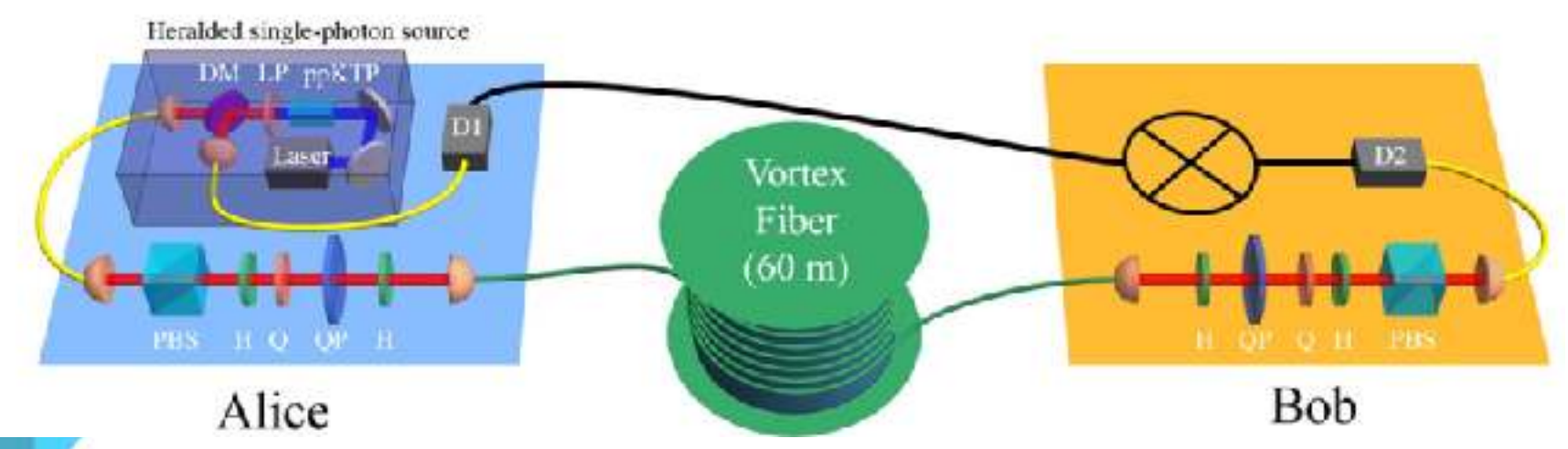

Fibre channel

A. Sit, F. Bouchard, R. Fickler, J. Gagnon-Bischoff, H. Larocque, K. Heshami, D. Elser, C. Peuntinger, K. Günthner, B. Heim, C. Marquardt, G. Leuchs, R. W. Boyd & E.K., *Optica* **4**, 1006 (2017).

F. Bouchard, A. Sit, F. Hufnagel, A. Abbas, Y. Zhang, K. Heshami, R. Fickler, C. Marquardt, G. Leuchs, R. W. Boyd & E.K., *Optics Express* **26**, 22563 (2018).

A Sit, R Fickler, F Alsaiani, F Bouchard, H Larocque, P Gregg, L Yan, R W Boyd, S Ramachandran & E.K., *Optics Letters* **43**, 4108 (2018).



NRC-uOttawa 5.4 km free-space link



A deck was designed with a cut-out allowing for an optical table to be isolated from the deck.

The shed of 11' by 8' can hold the optical table and all lab equipment while providing enough space for team members to work both inside and outside of the shed for alignment.

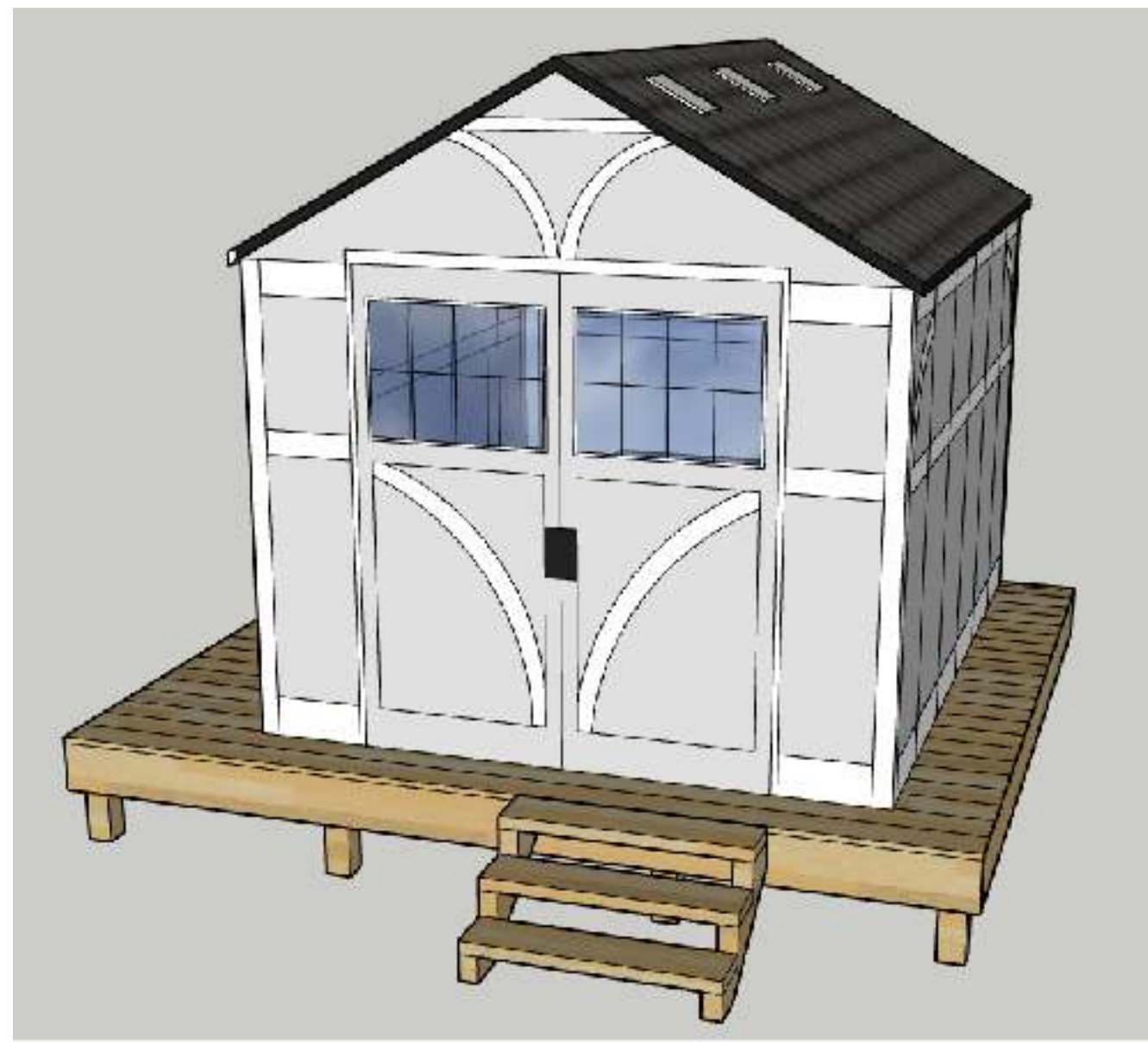

NRC-uOttawa 5.4 km free-space link



A deck was designed with a cut-out allowing for an optical table to be isolated from the deck.



The shed of 11' by 8' can hold the optical table and all lab equipment while providing enough space for team members to work both inside and outside of the shed for alignment.



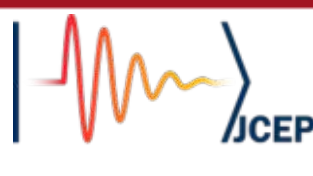

NRC-uOttawa 5.4 km free-space link

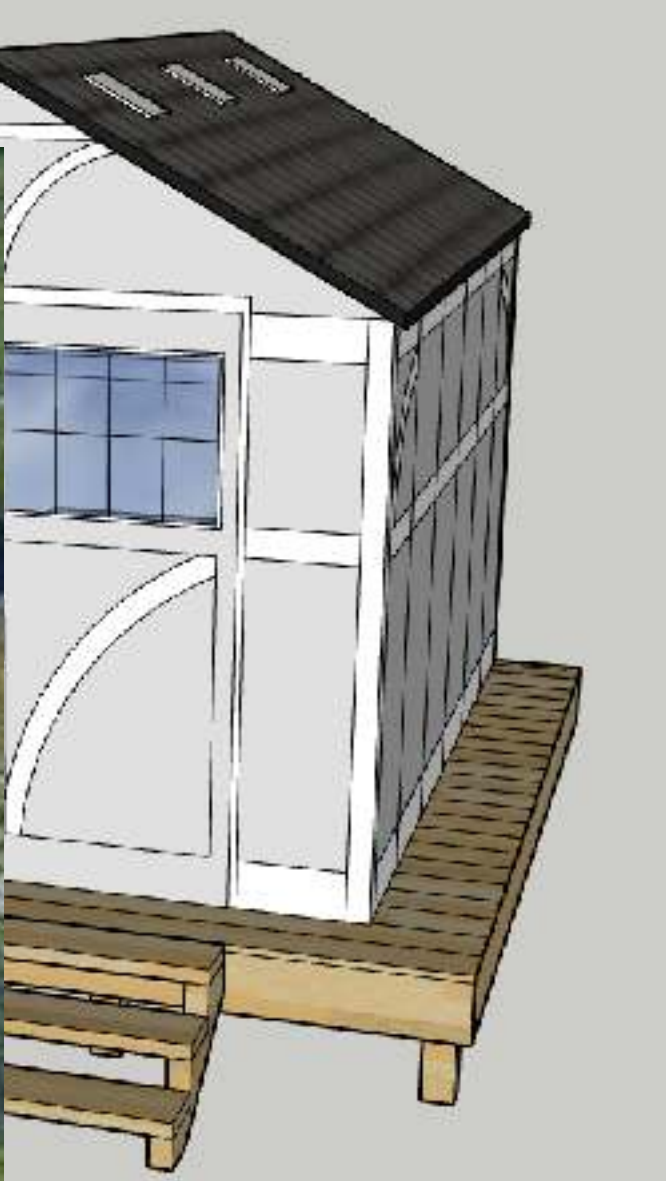
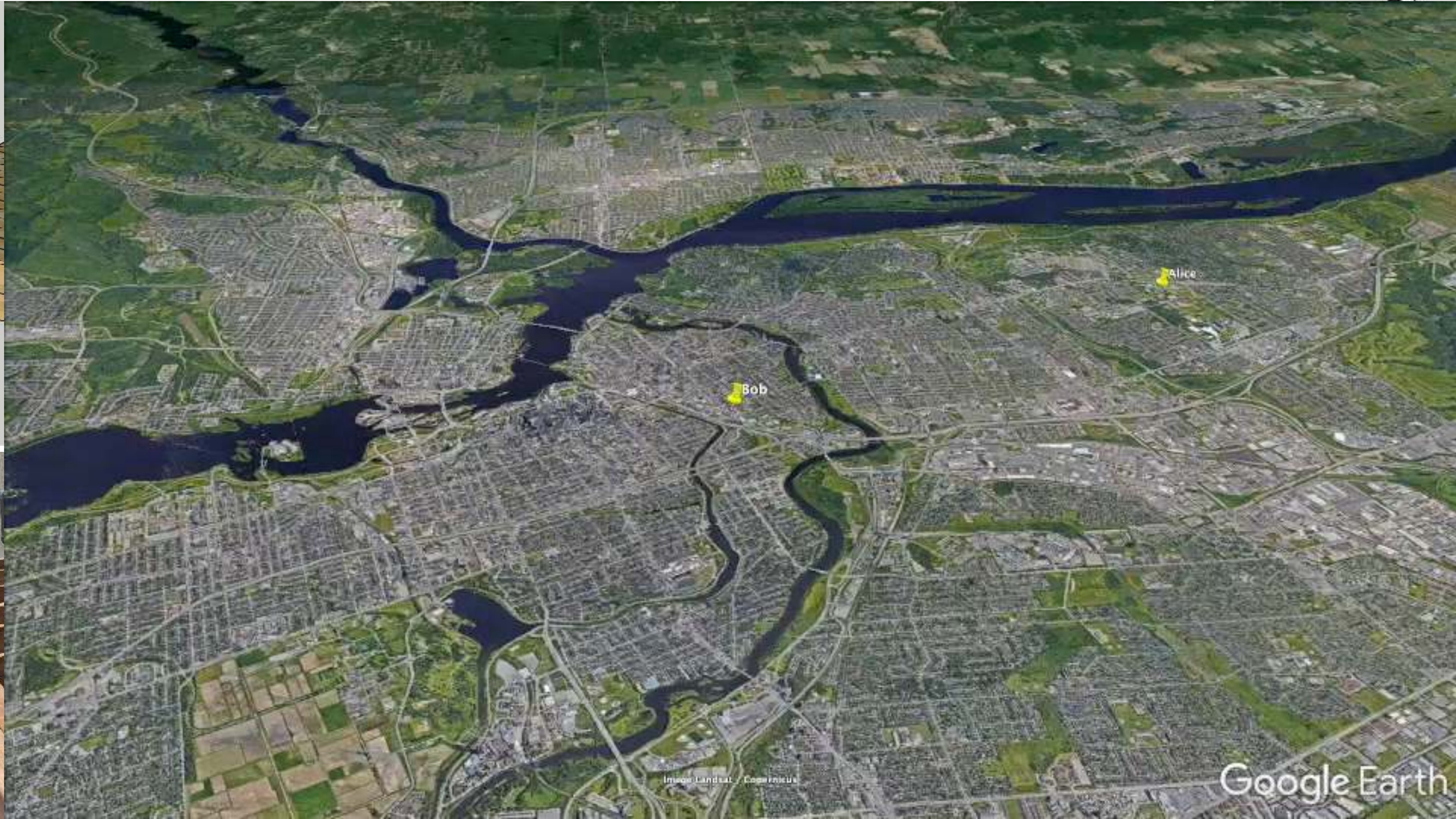

Google Earth

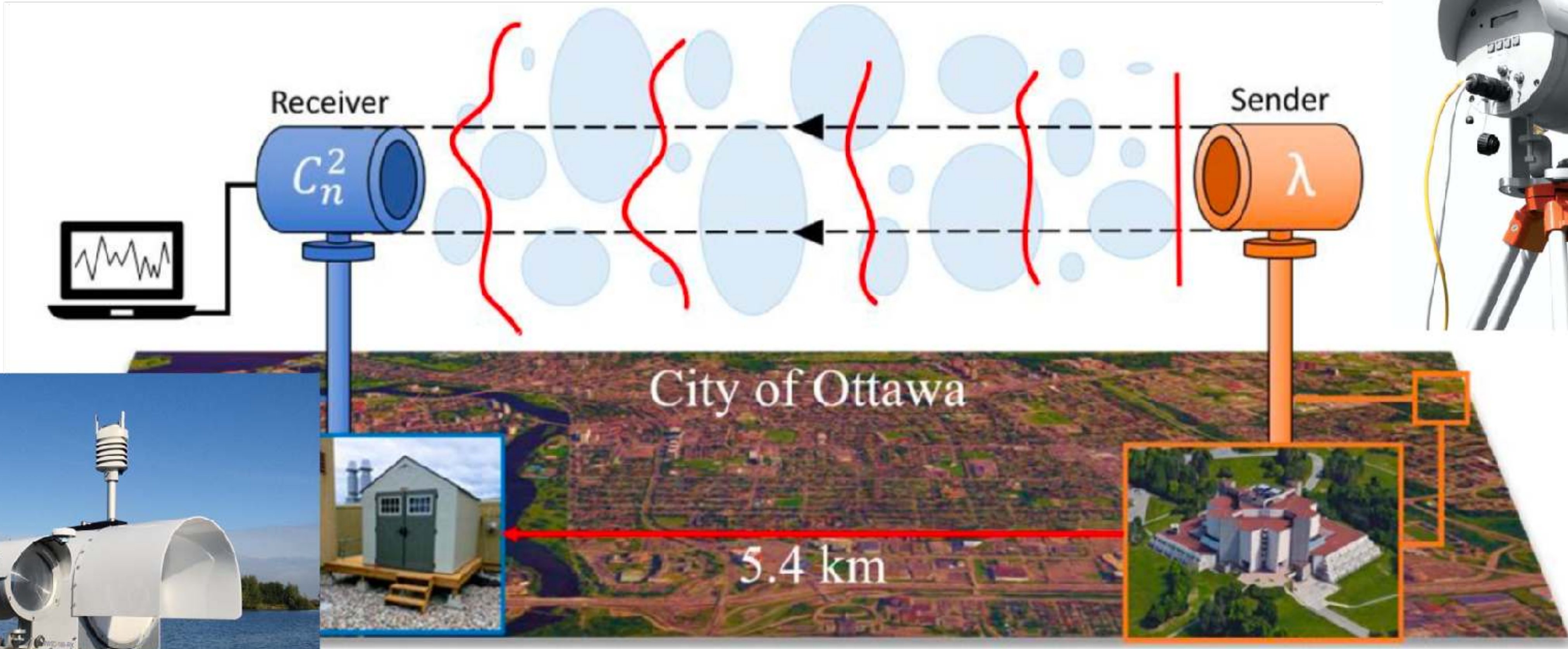
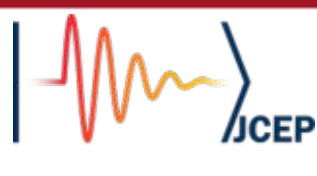

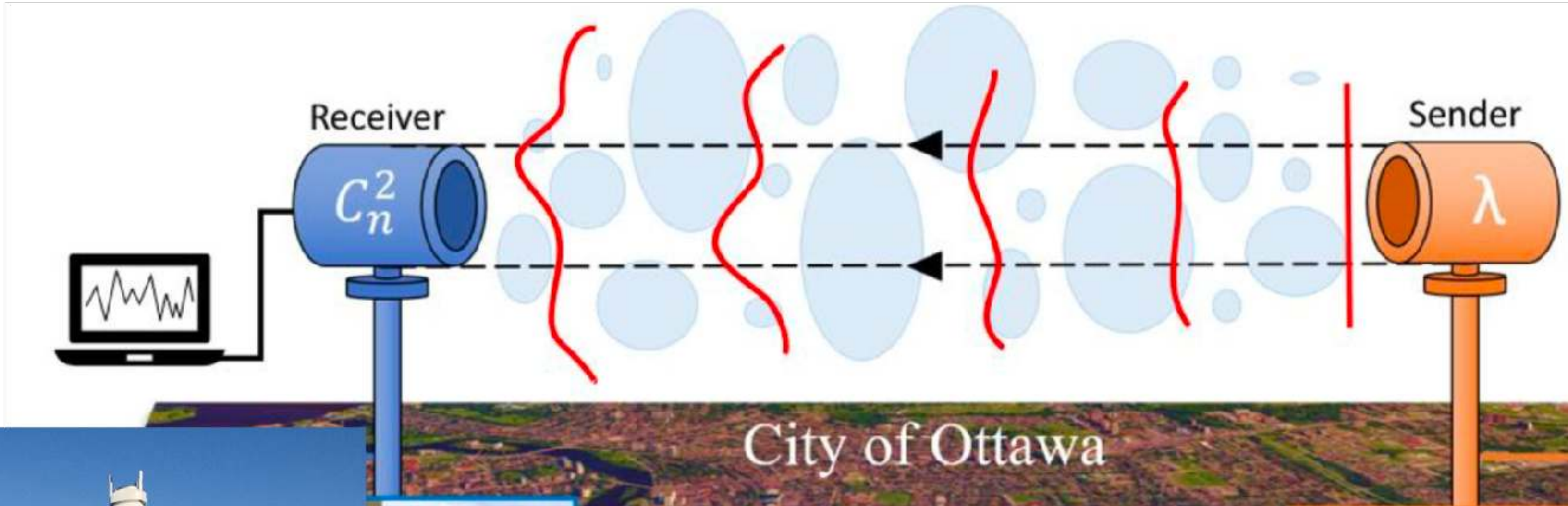
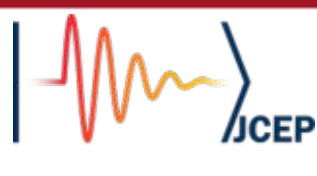

Adaptive Optics System

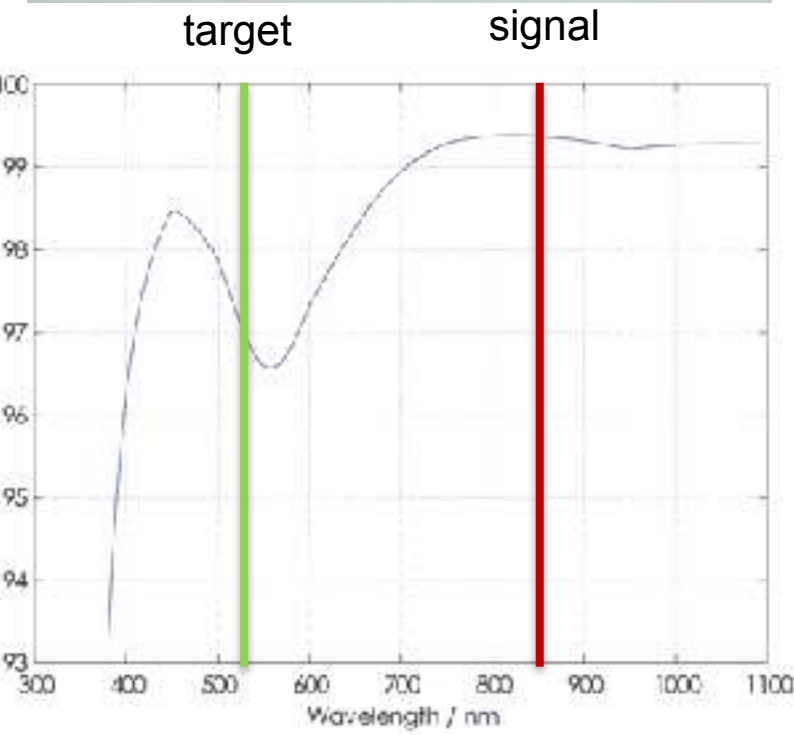
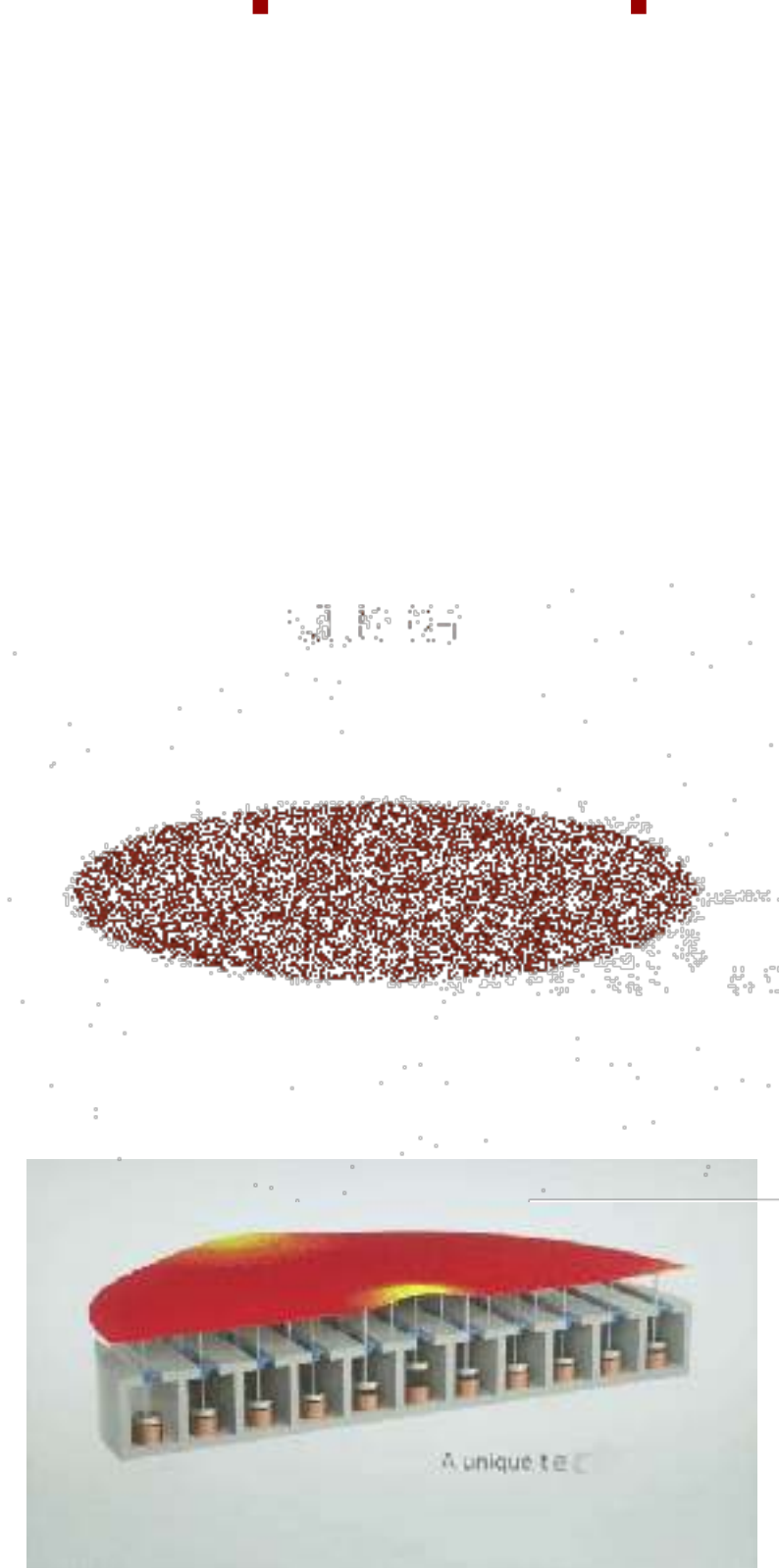

Property	Specification*	Result	Unit
Mirror best flat, residual error	<7	6.44	nm RMS
Wavefront 3x3 stroke	>12.5	17.11	µm PV
Wavefront tip/tilt stroke	>20	22.61	µm PV
Wavefront defocus stroke	>15	18.53	µm PV
Wavefront astigmatism stroke	>15	20.75	µm PV
Linearity	<3	0.28	%
Hysteresis	<2	0.63	%
Peak frequency	>1200	1556	Hz
Frequency at -45° phase	>1000	1832	Hz
Settling time	<0.75	0.61	ms

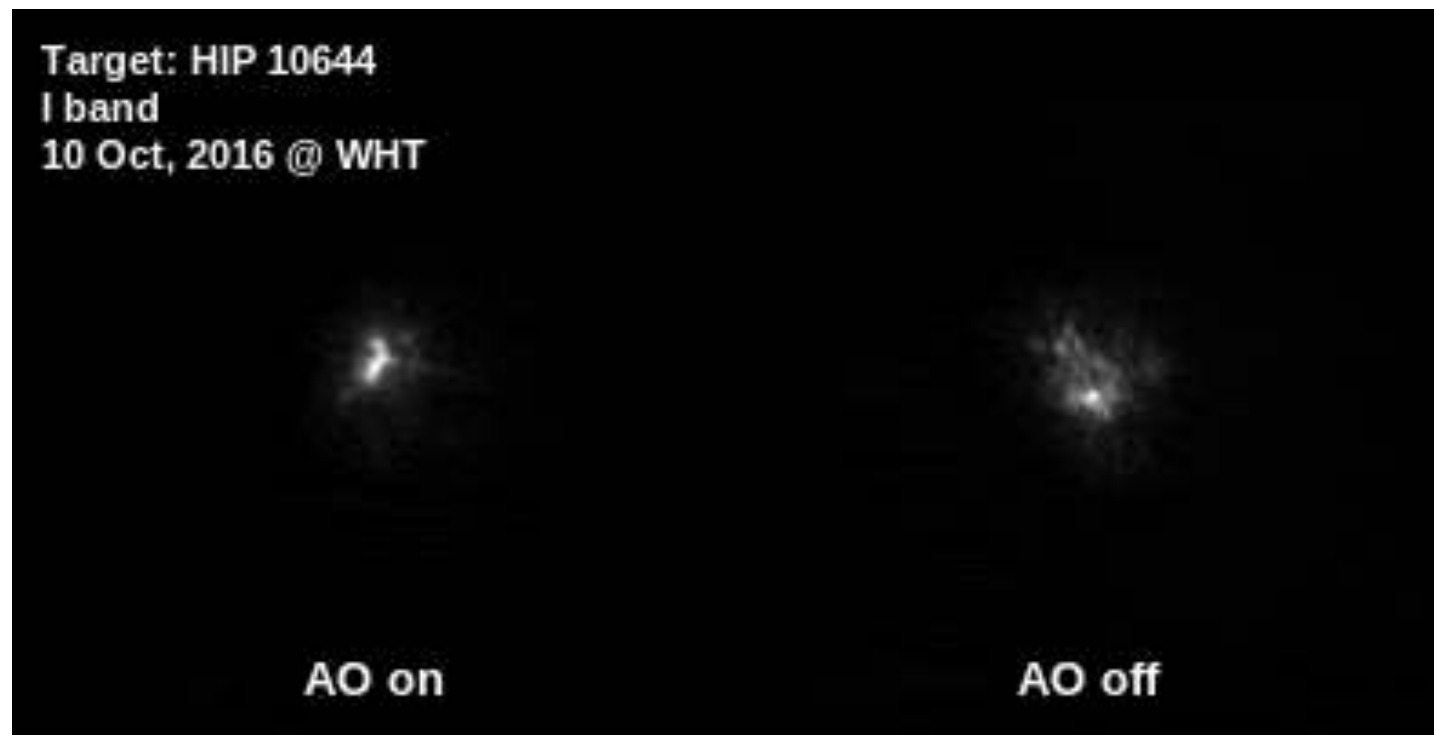
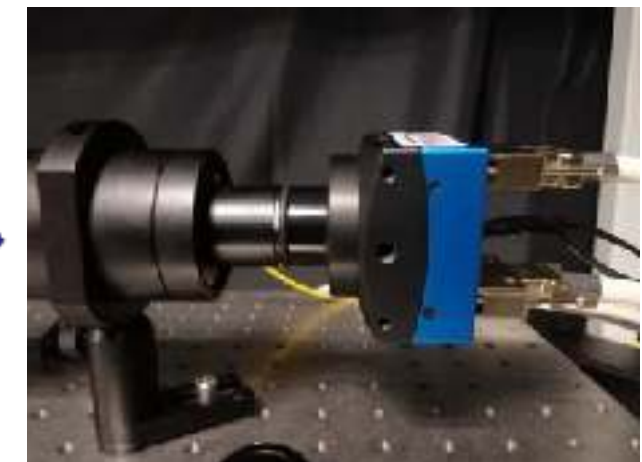
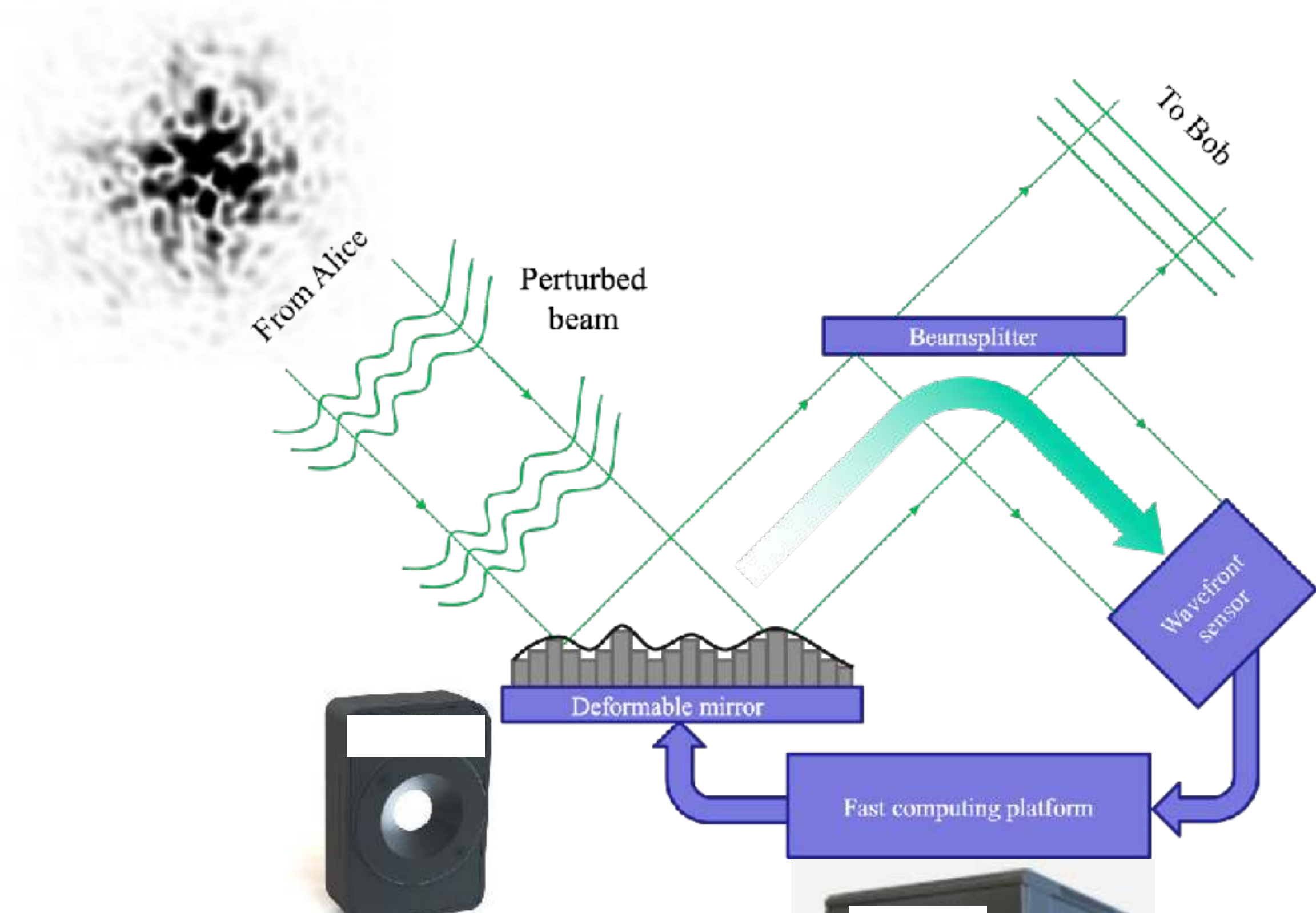

up to 5 kHz framerate, average 2 kHz
91 µs total latency
335 Hz rejection bandwidth

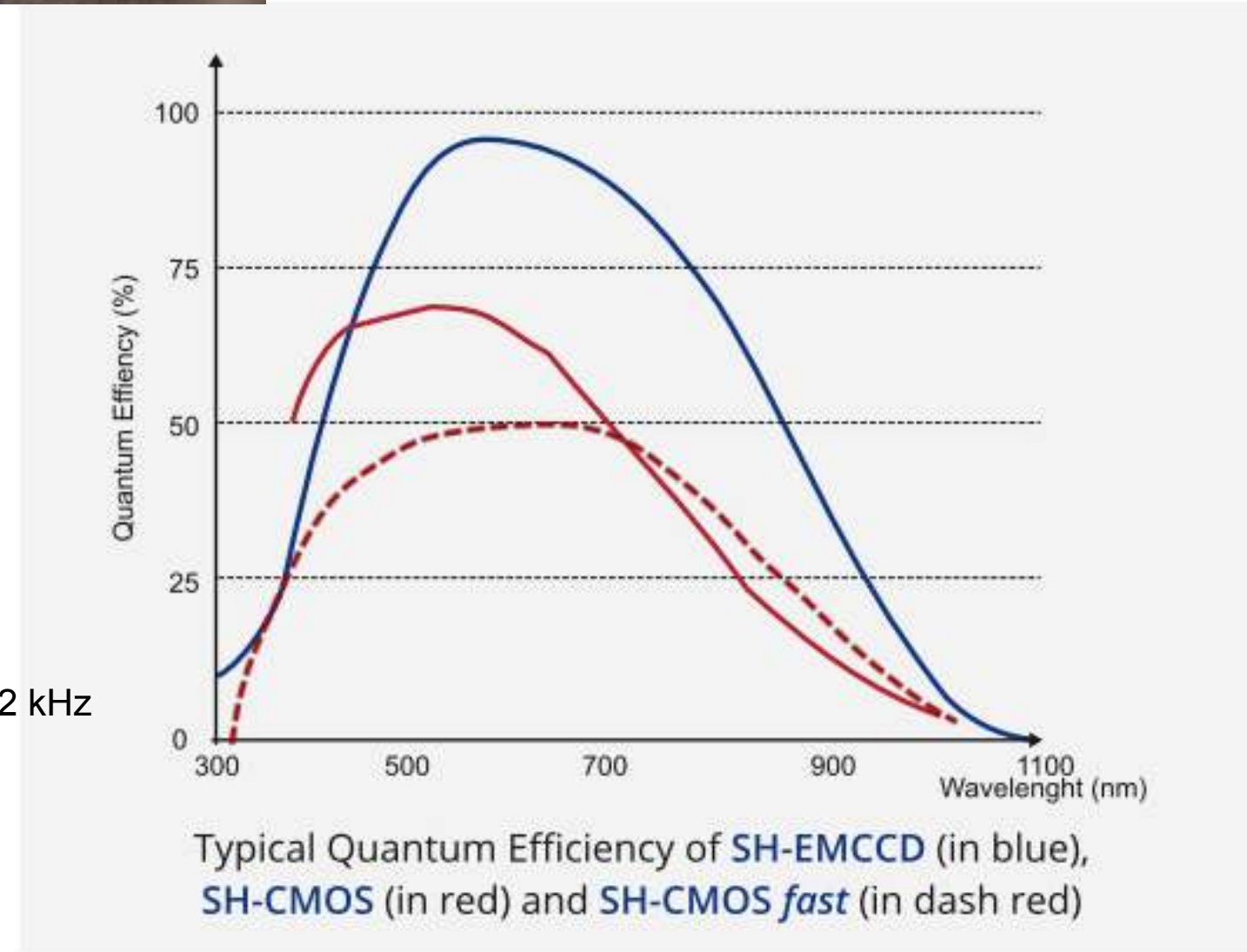

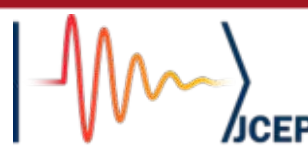

Other channels: water

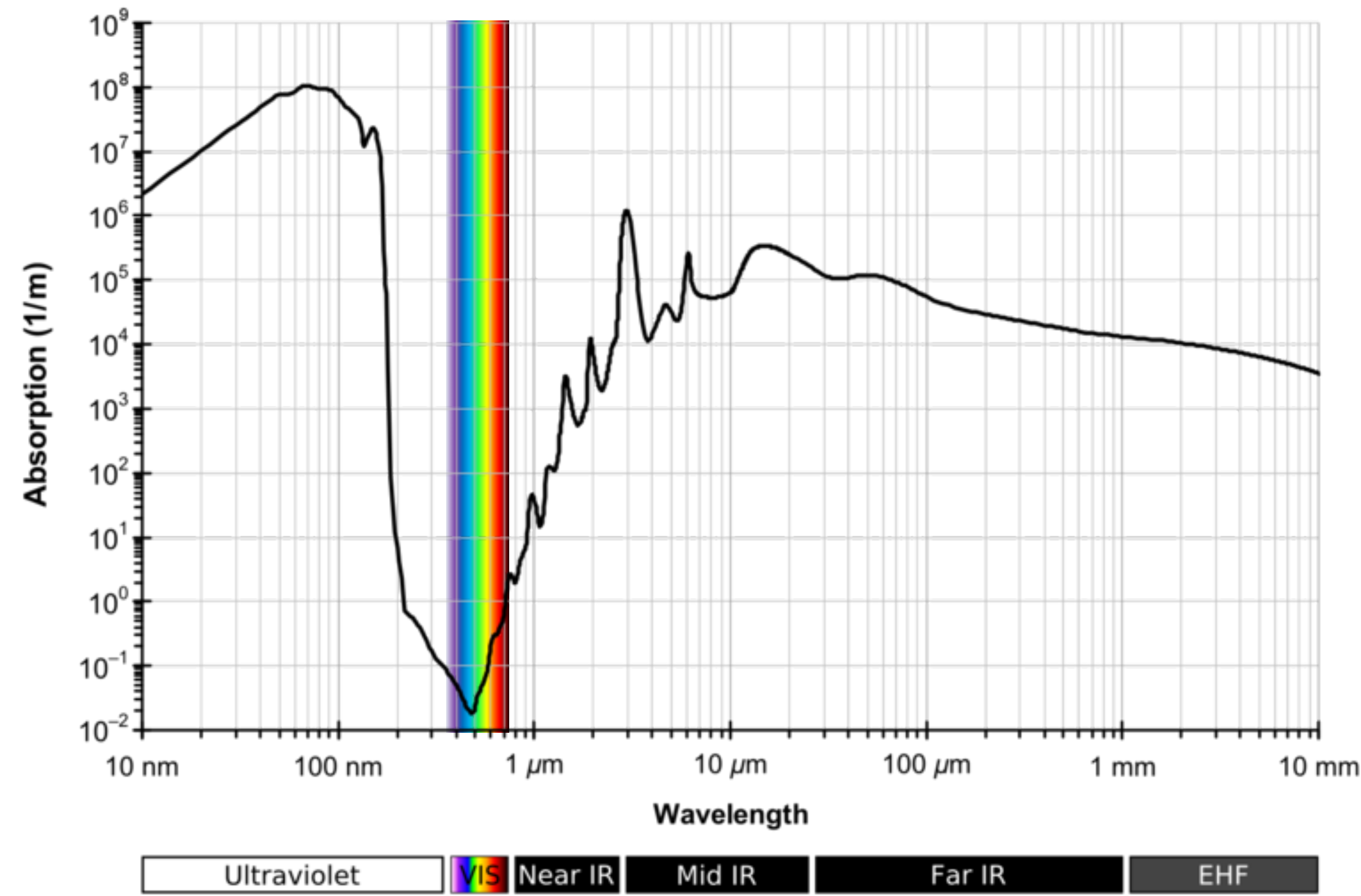

Beer's Law $L = -\frac{1}{\alpha} \ln\left(\frac{I}{I_0}\right)$

1550 nm	17000 m ⁻¹	300 μm
810 nm	2 m ⁻¹	2 m
633 nm	0.3 m ⁻¹	15 m
532 nm	0.06 m ⁻¹	75 m
420 nm	0.02 m ⁻¹	230 m



S. A. Sullivan, Opt. Soc. Am. J., 53, 962--968, (1963).
https://en.wikipedia.org/wiki/Electromagnetic_absorption_by_water

Other channels: water

710 nm $\xrightarrow{0.9 \text{ m}^{-1}}$ 5 m

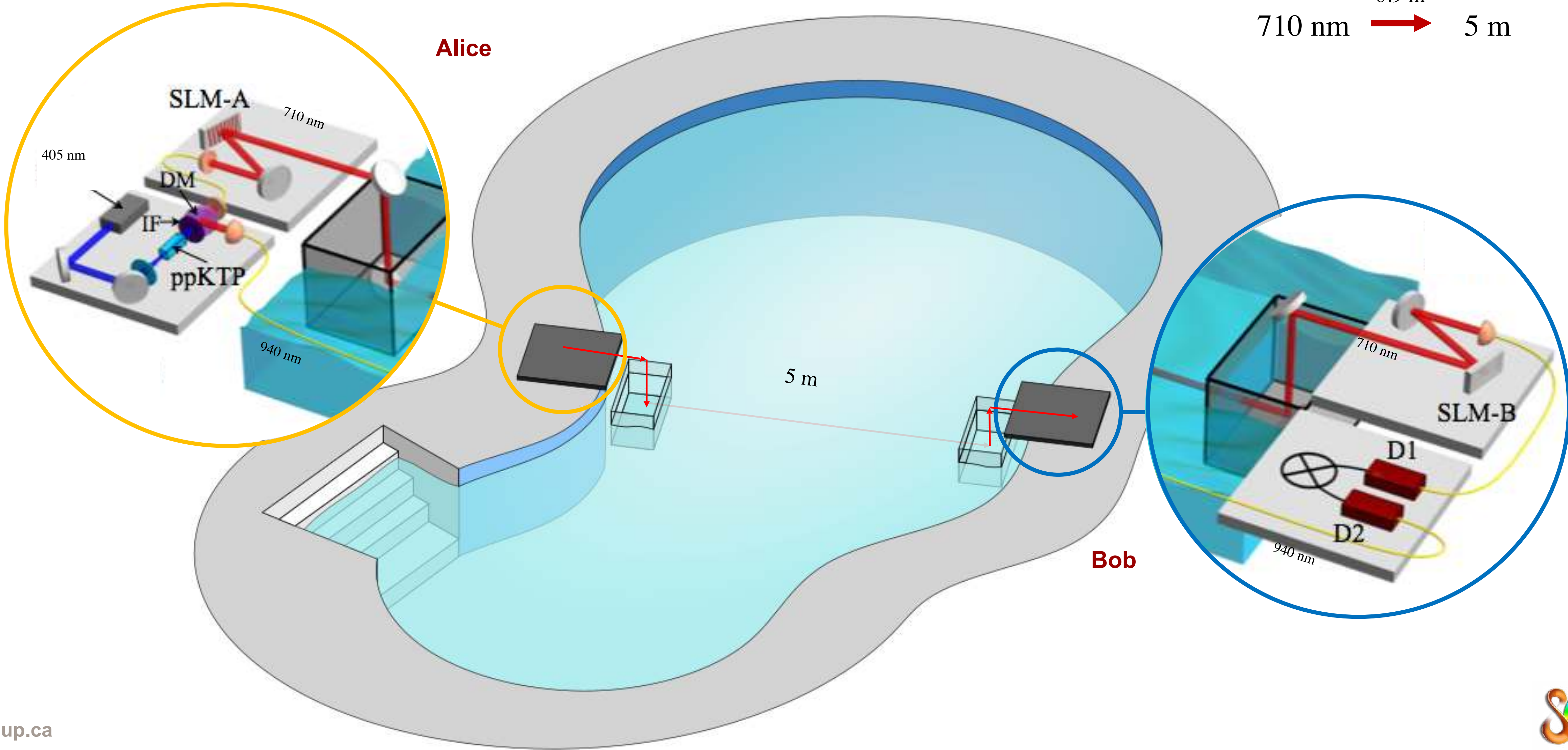

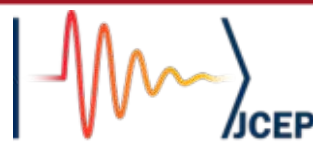

Quantum Cryptography through Underwater Channels



Quantum Cryptography through Underwater Channels

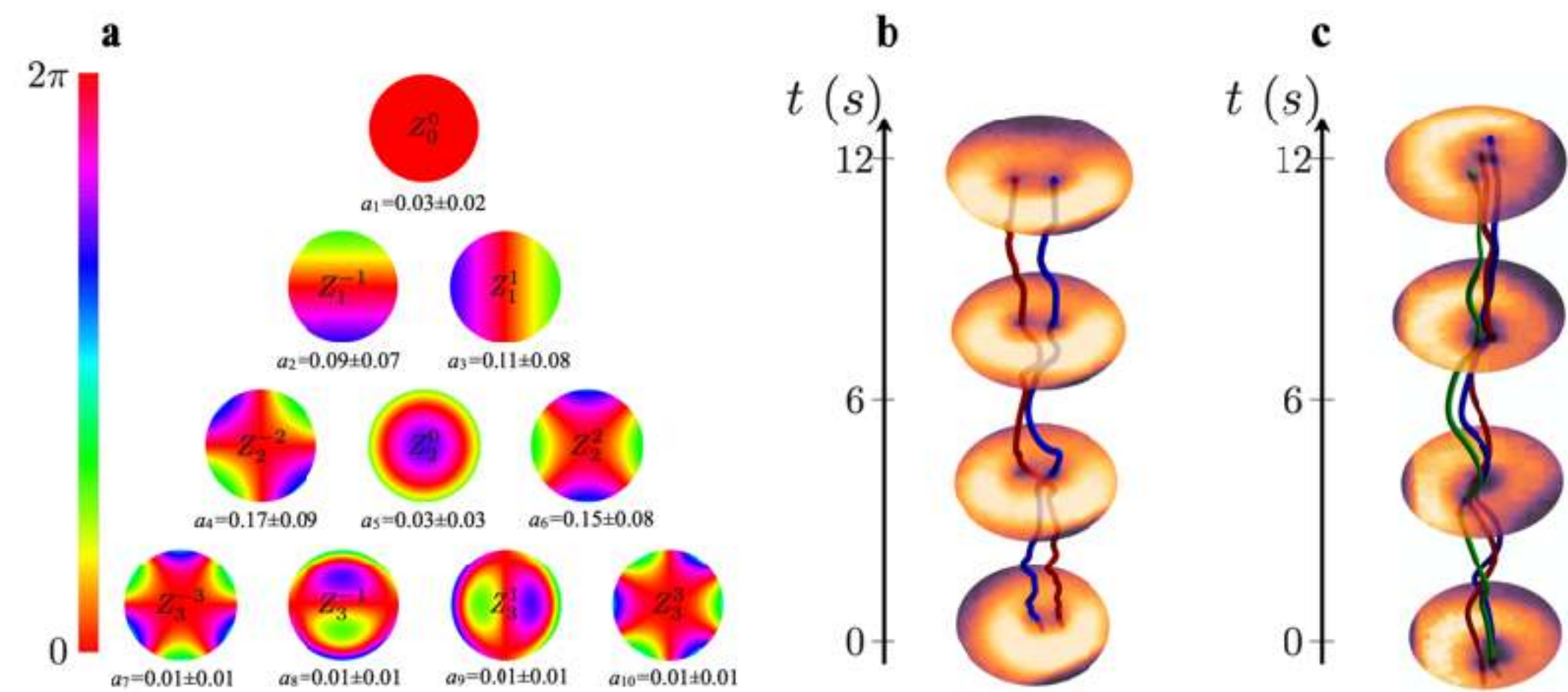

Quantum Cryptography through Underwater Channels

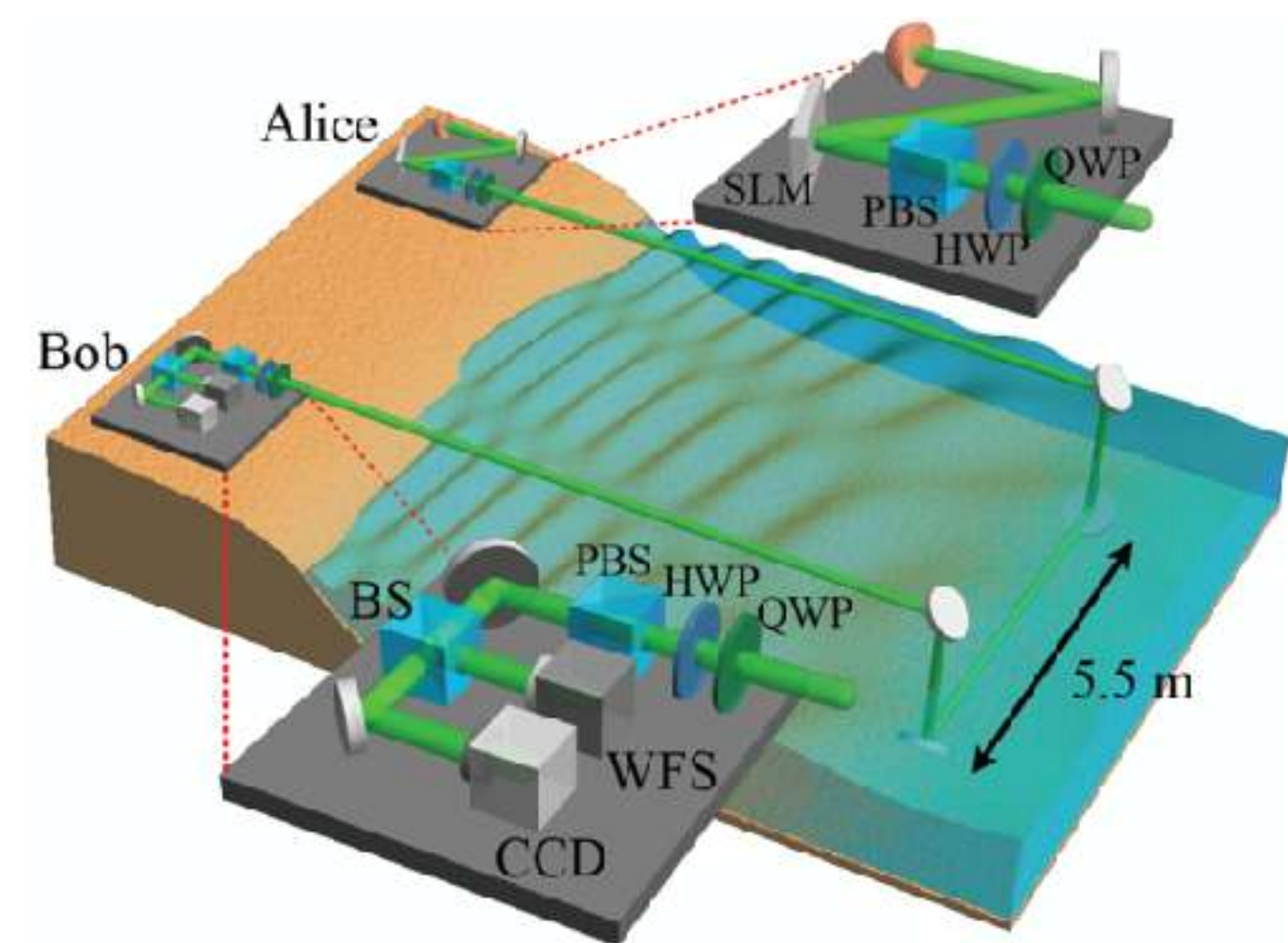
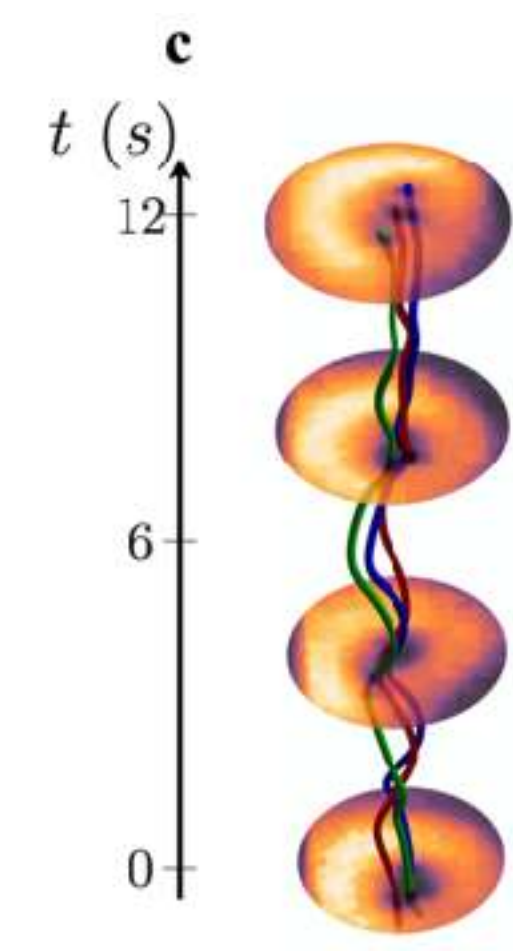
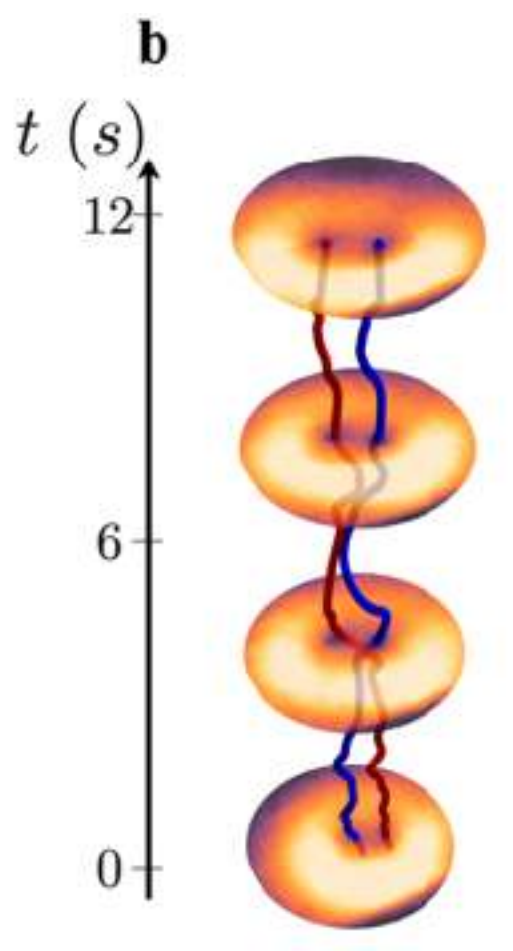
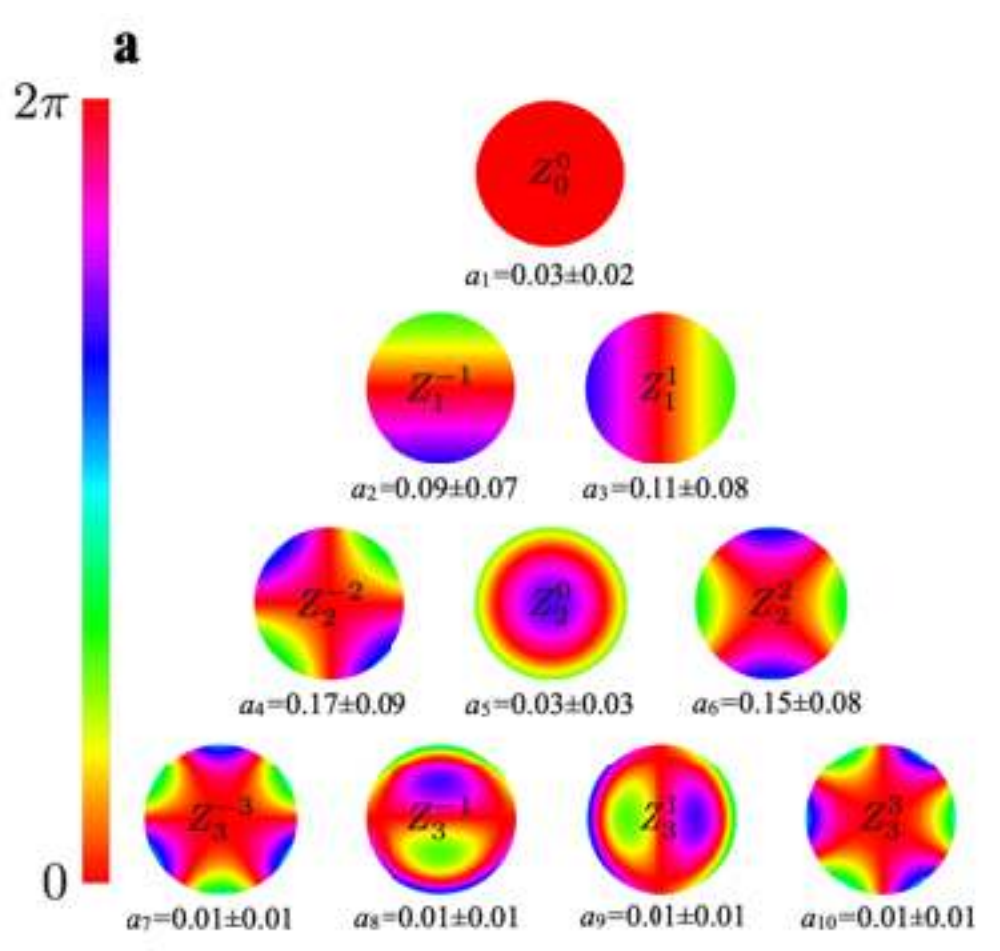
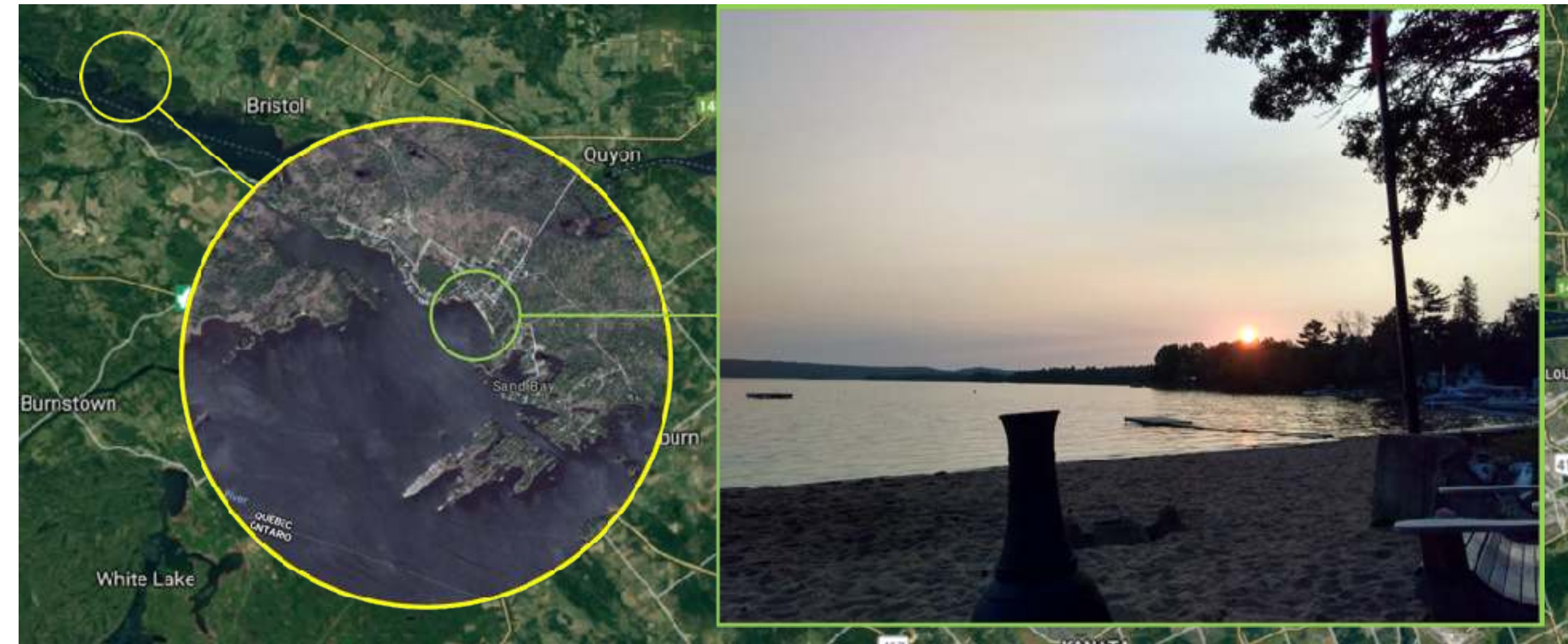

$ H\rangle$	0.93	0.06	0.40	0.59
$ V\rangle$	0.02	0.97	0.45	0.54
$ A\rangle$	0.49	0.50	0.97	0.03
$ D\rangle$	0.53	0.47	0.04	0.96
	$ H\rangle$	$ V\rangle$	$ A\rangle$	$ D\rangle$

Underwater Quantum Cryptography through 30 m Channel

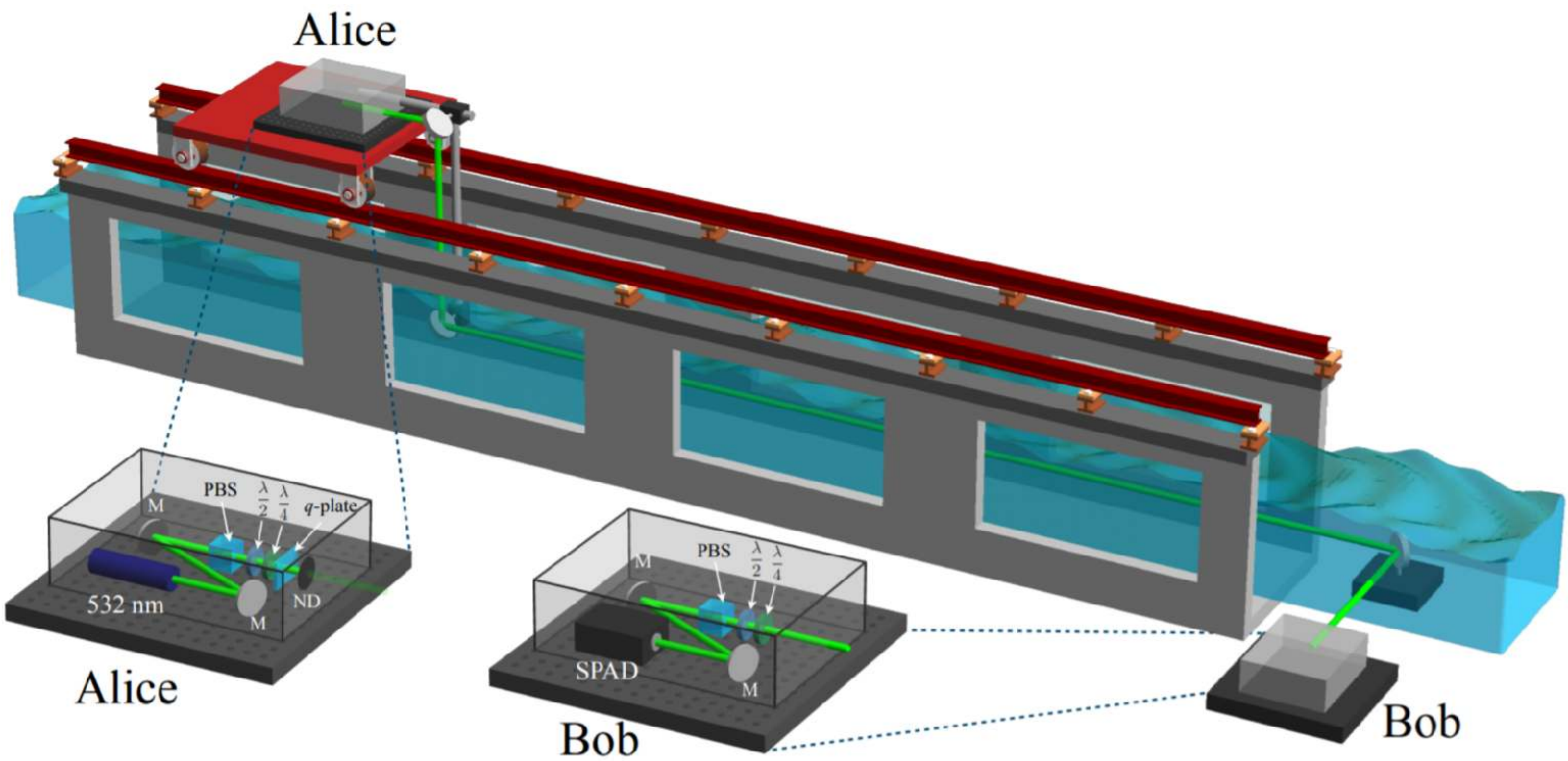

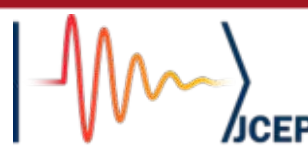

Underwater Quantum Cryptography through 30 m Channel



Bob

Bob



Underwater Quantum Cryptography through 30 m Channel

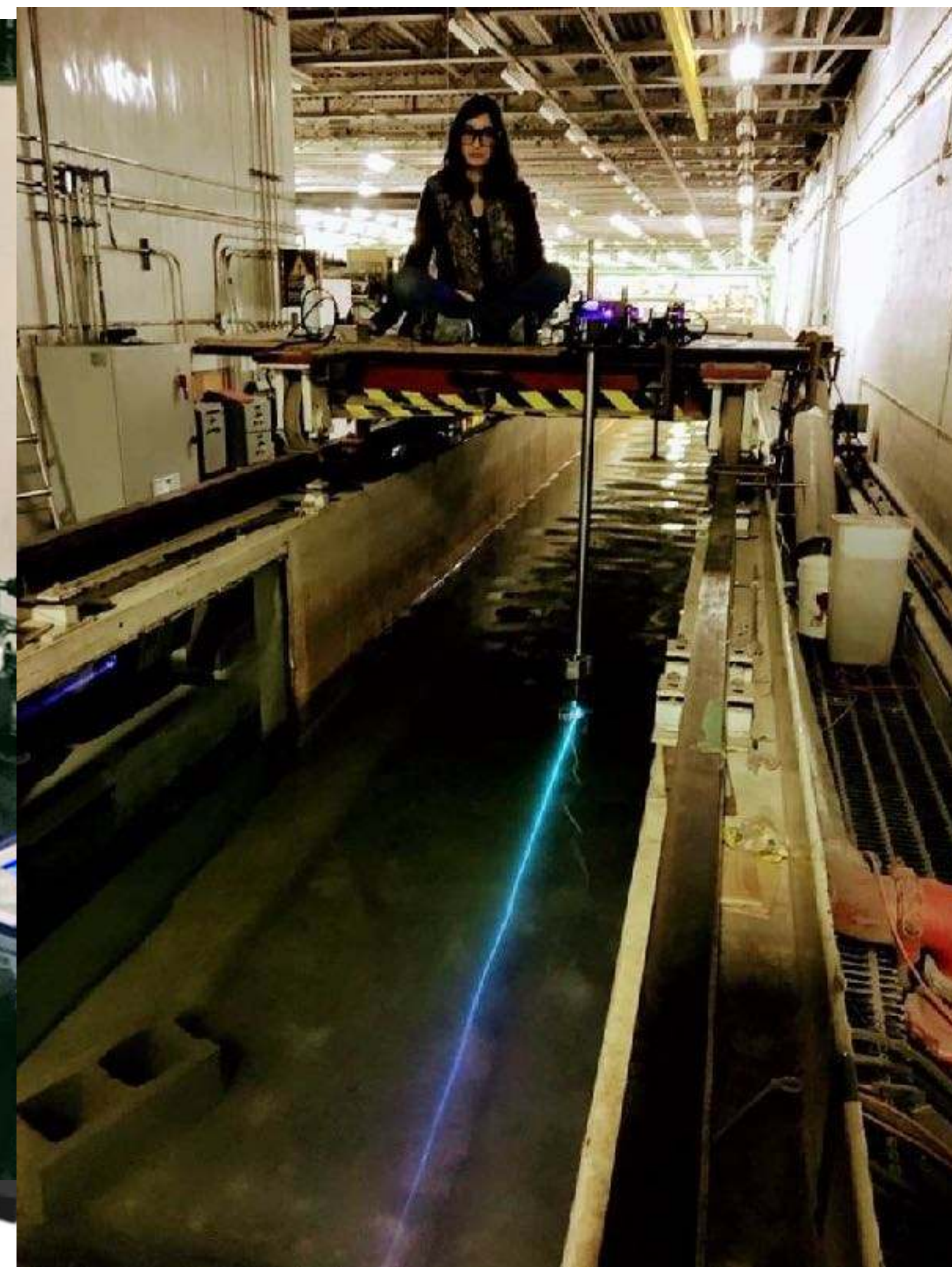

Bob

Underwater Quantum Cryptography in the NRC Flumes

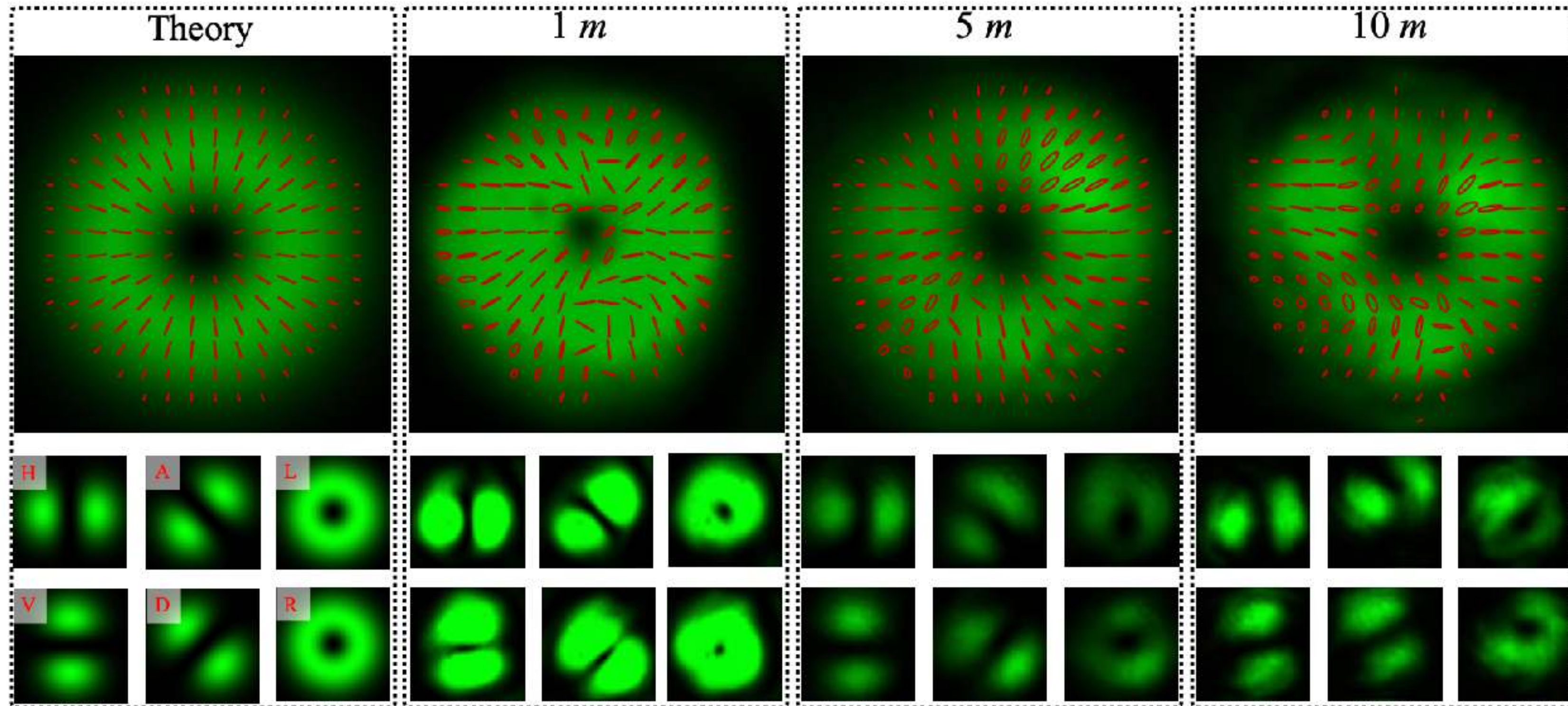

Underwater Quantum Cryptography in the NRC Flumes

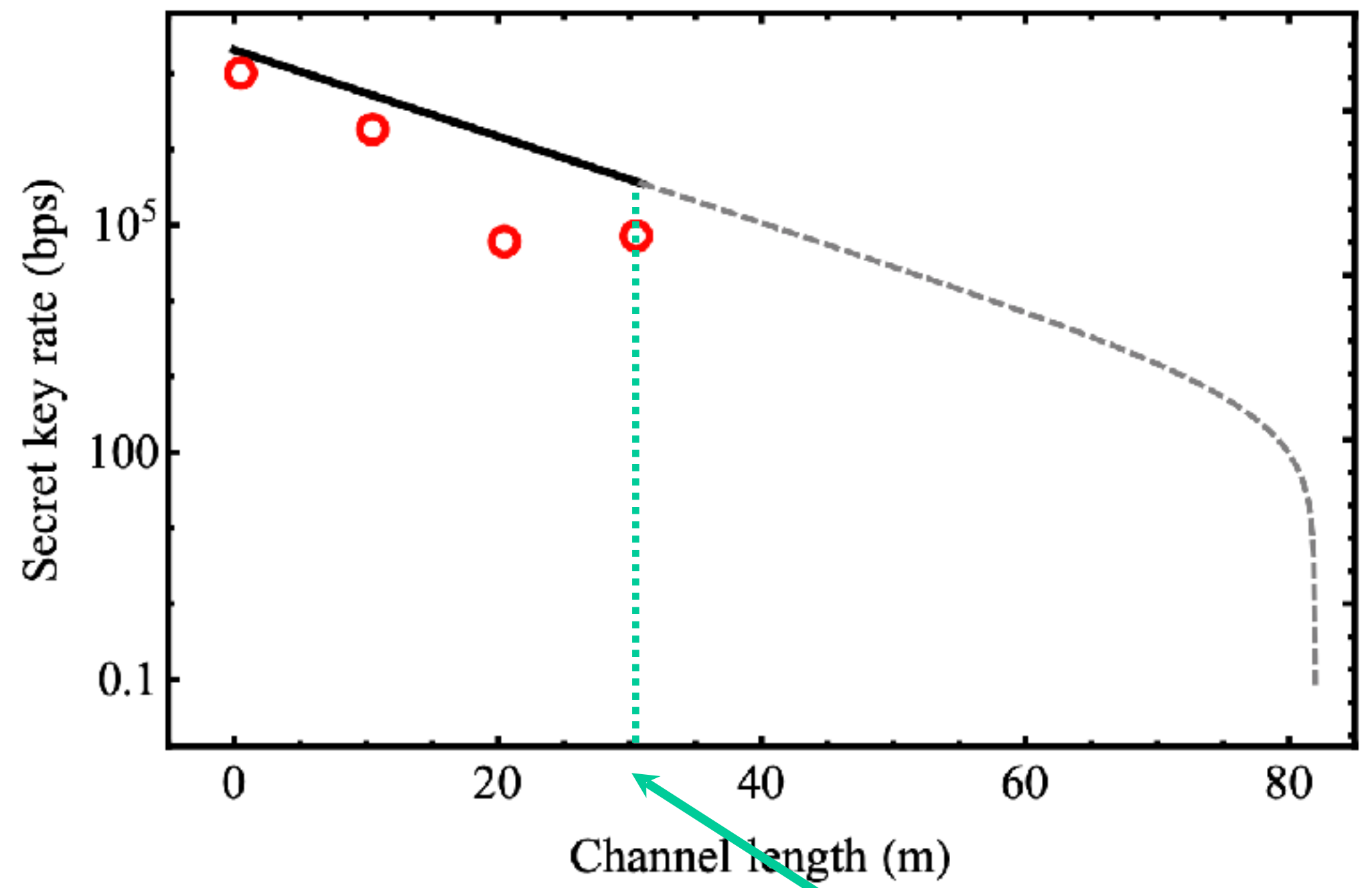
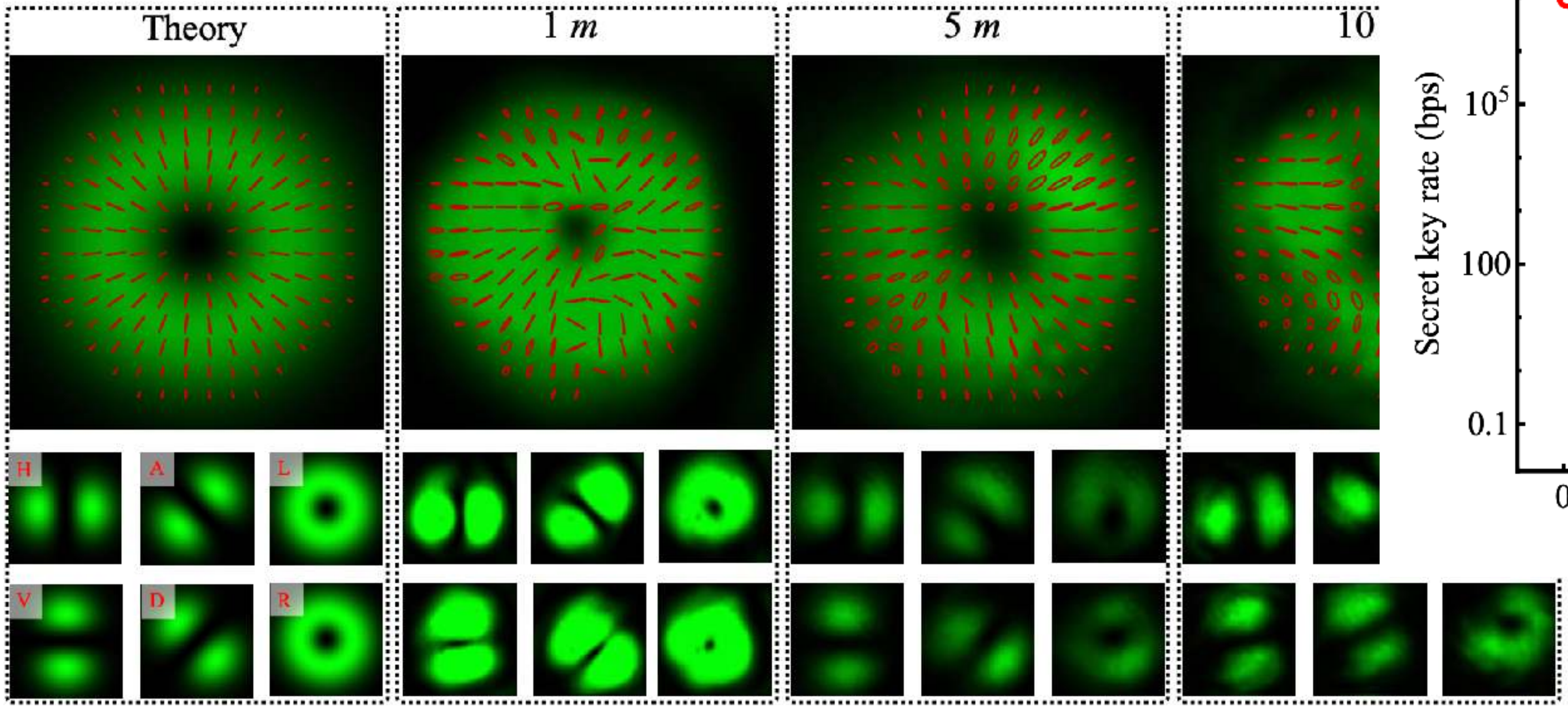

Key rate at 30.5 m is about 80 kb/s

Quantum Communication in a Curved Spacetime Geometry

$$\psi_{\text{Bob}}(x^\mu) \simeq \psi^{(0)}(x^\mu) + \epsilon\psi^{(1)}(x^\mu) + \dots$$

$$\square^{(0)}\psi^{(1)} = -R_{+\bar{a}+\bar{b}} x^{\bar{a}} x^{\bar{b}} \partial_-^2 \psi^{(0)}$$

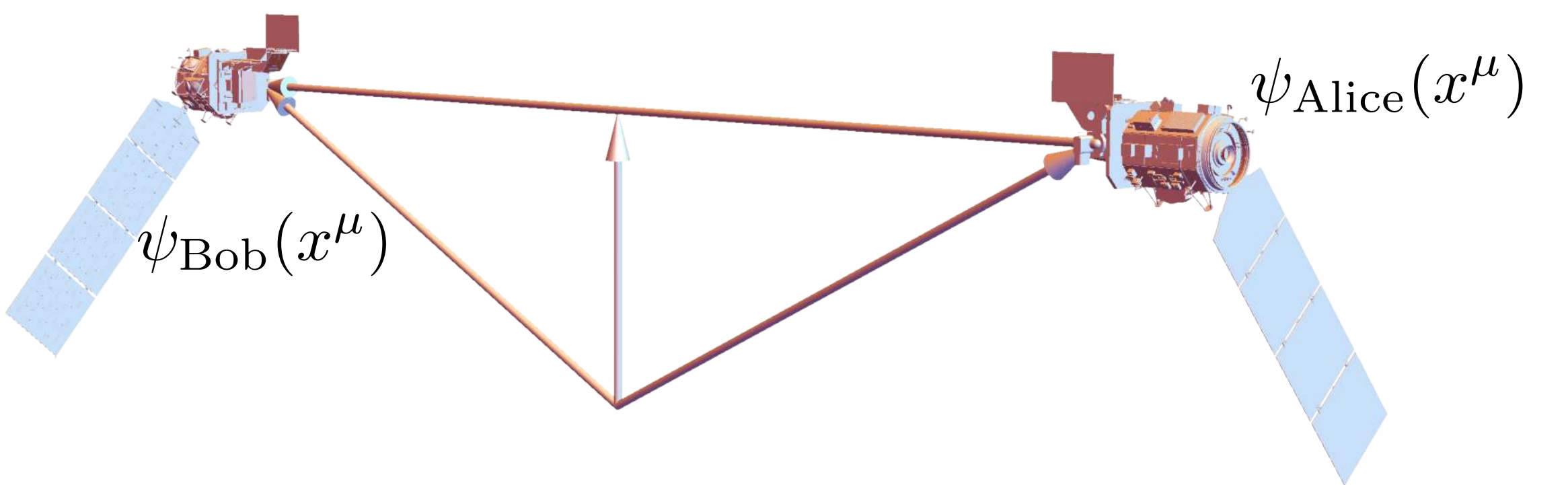
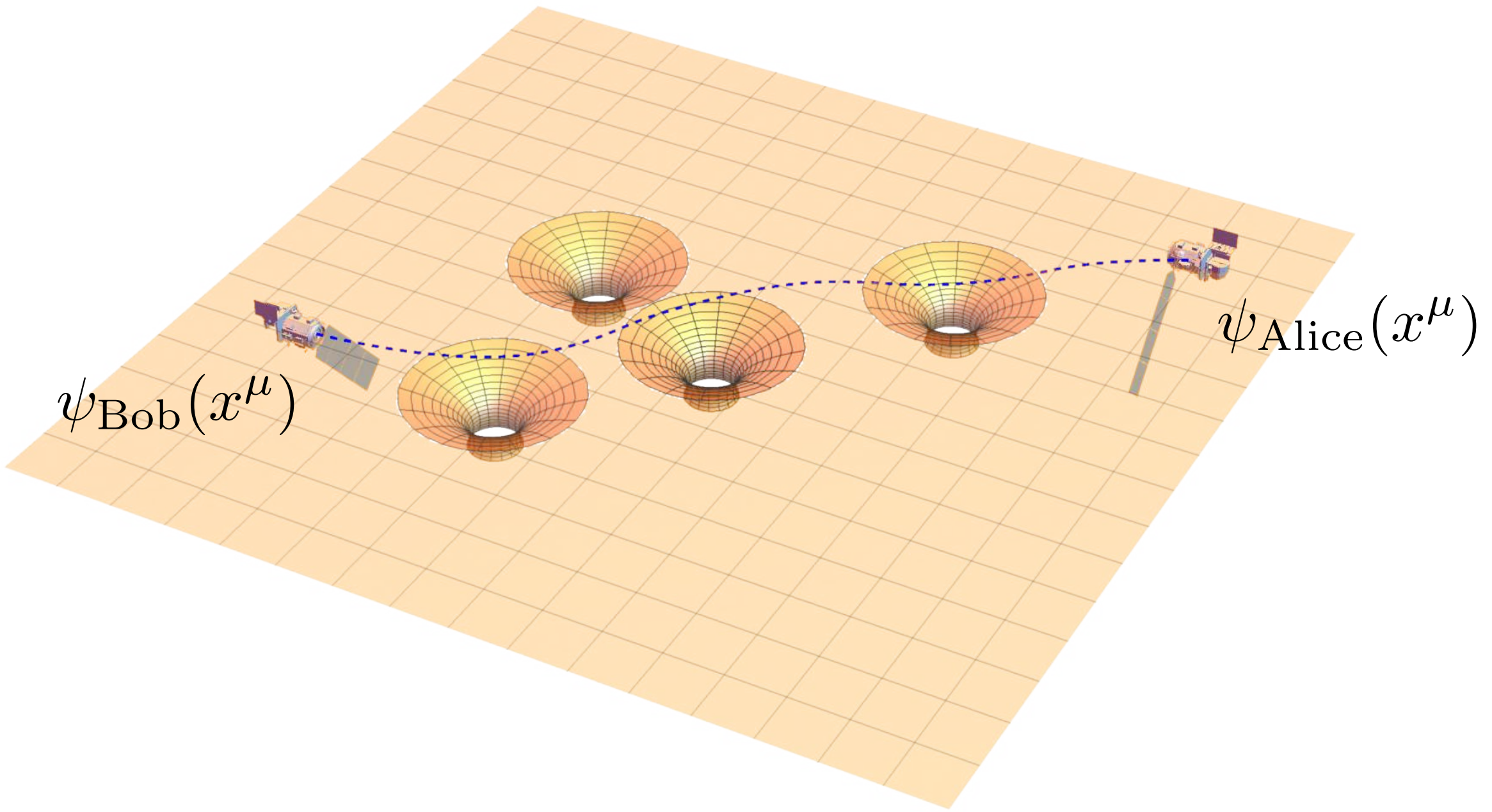

Quantum Communication in a Curved Spacetime Geometry

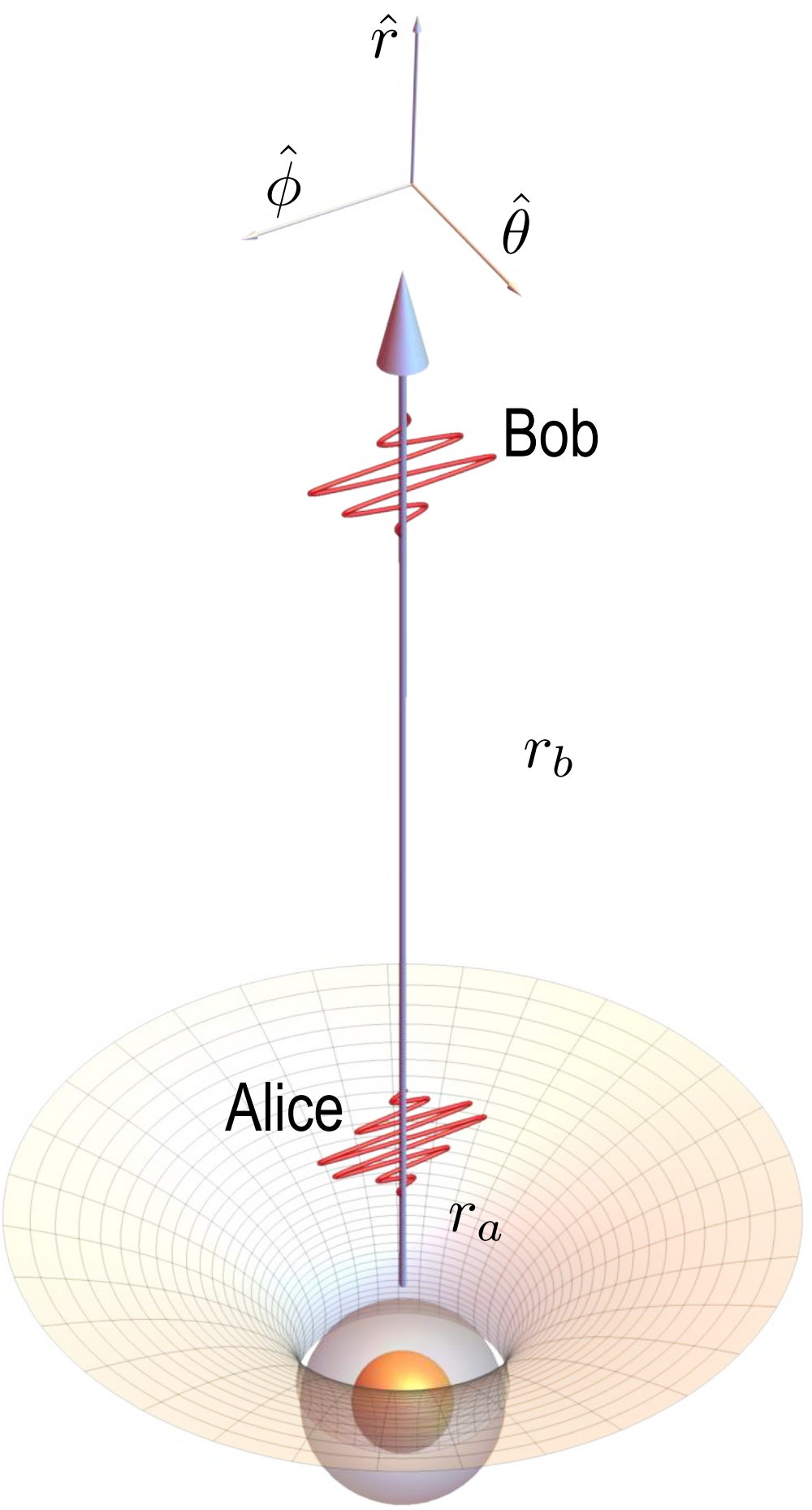
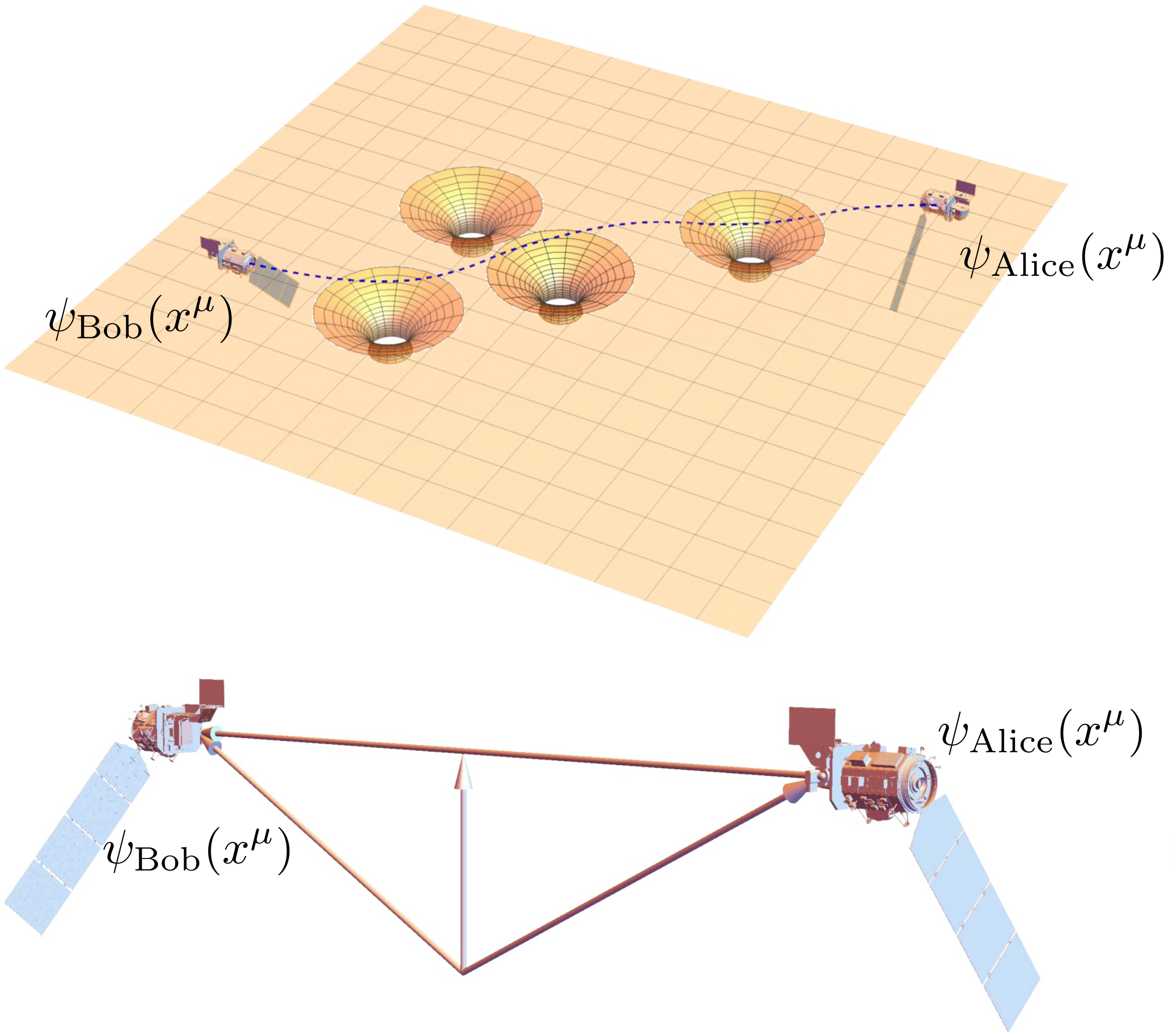

$$\psi_{\text{Bob}}(x^\mu) \simeq \psi^{(0)}(x^\mu) + \epsilon \psi^{(1)}(x^\mu) + \dots$$

$$\square^{(0)} \psi^{(1)} = -R_{+\bar{a}+\bar{b}} x^{\bar{a}} x^{\bar{b}} \partial_-^2 \psi^{(0)}$$

Quantum Communication in a Curved Spacetime Geometry

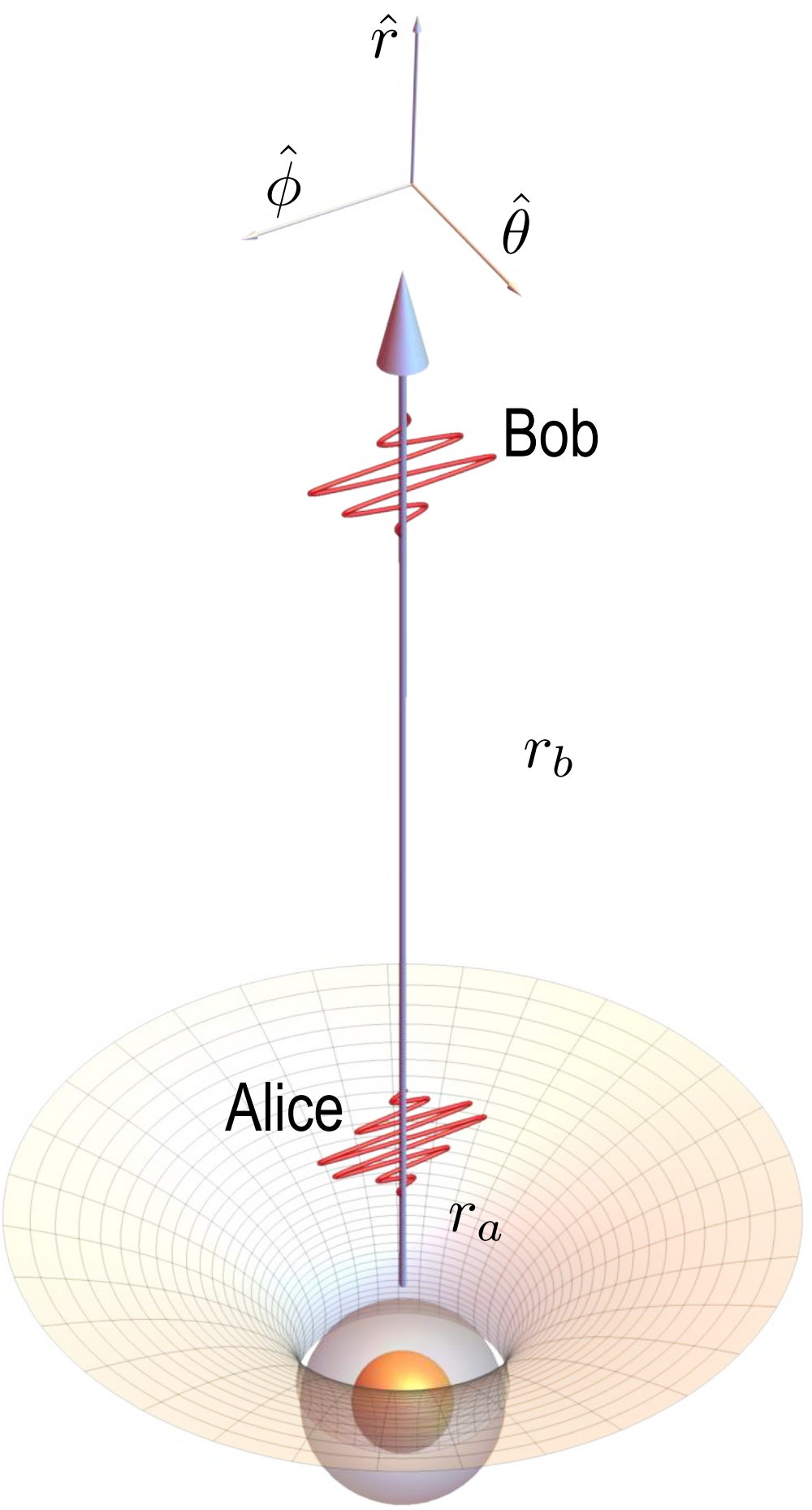
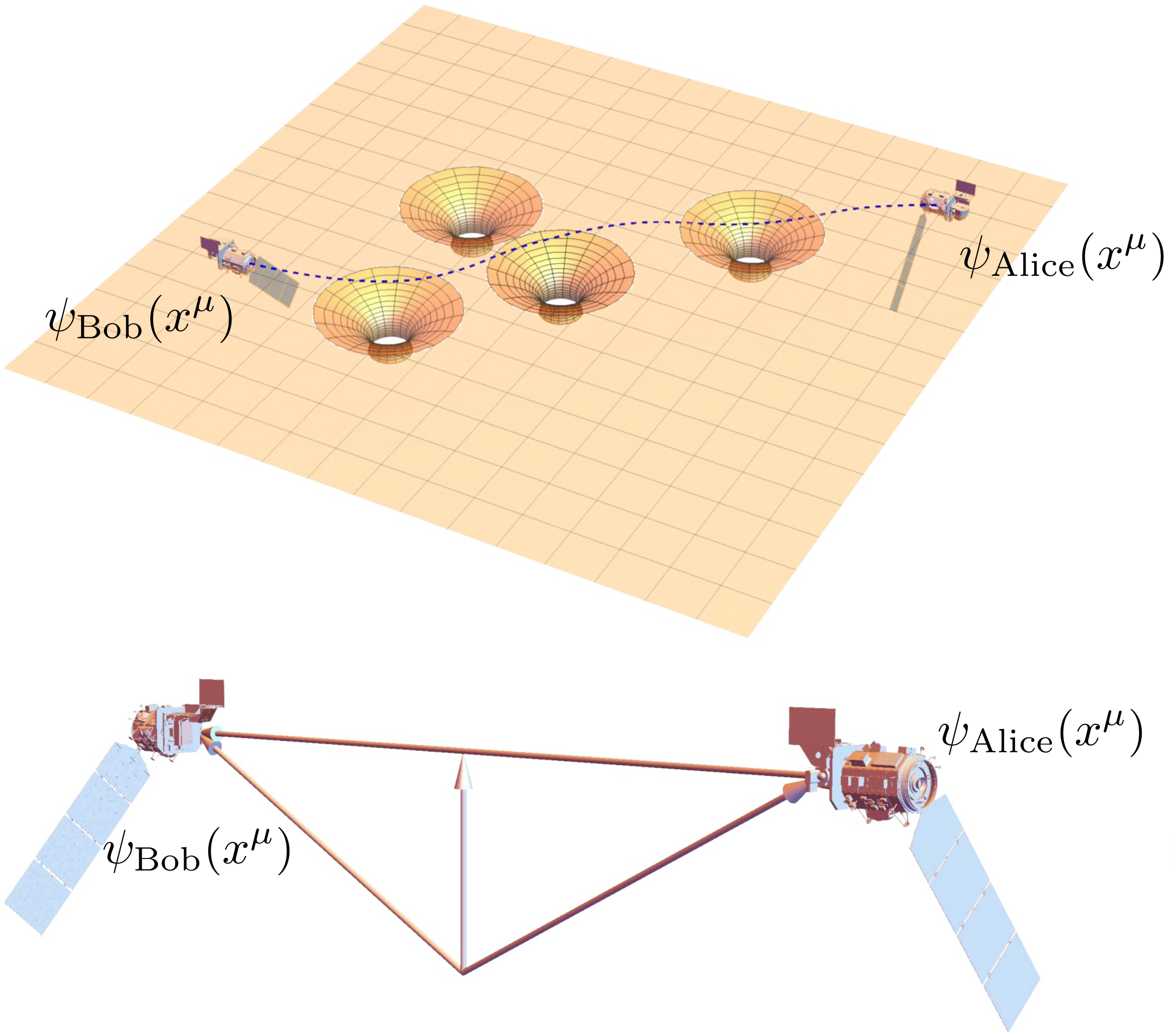

$$\psi_{\text{Bob}}(x^\mu) \simeq \psi^{(0)}(x^\mu) + \epsilon \psi^{(1)}(x^\mu) + \dots$$

$$\square^{(0)} \psi^{(1)} = -R_{+\bar{a}+\bar{b}} x^{\bar{a}} x^{\bar{b}} \partial_-^2 \psi^{(0)}$$

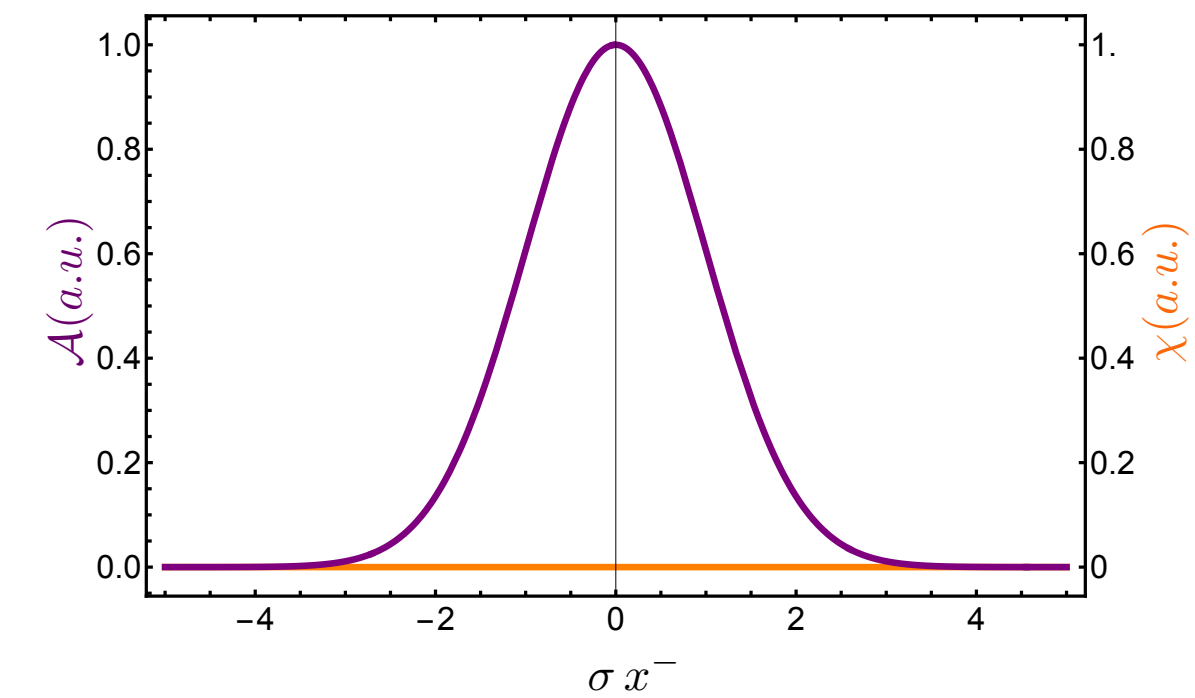

Quantum Communication in a Curved Spacetime Geometry

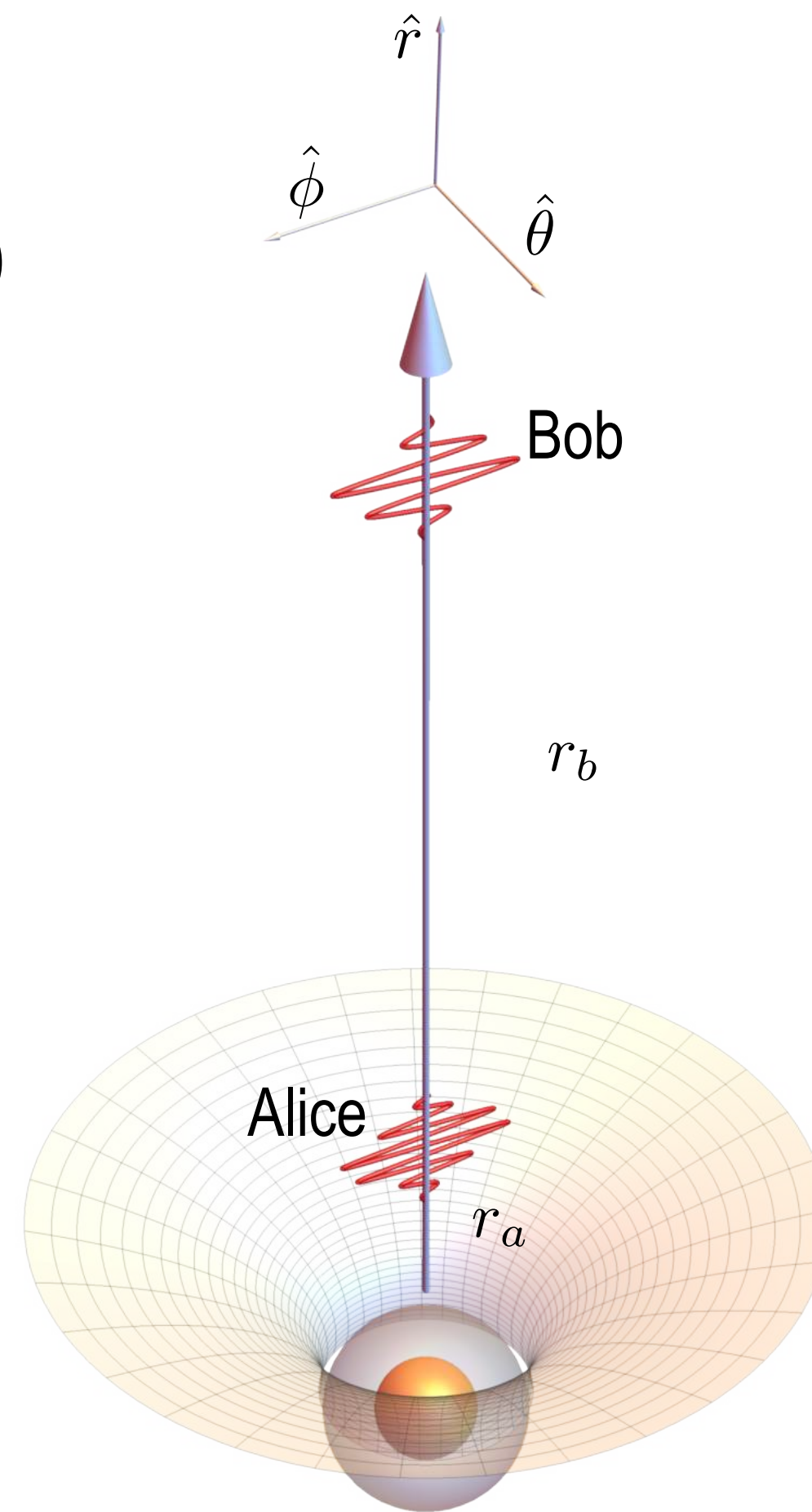
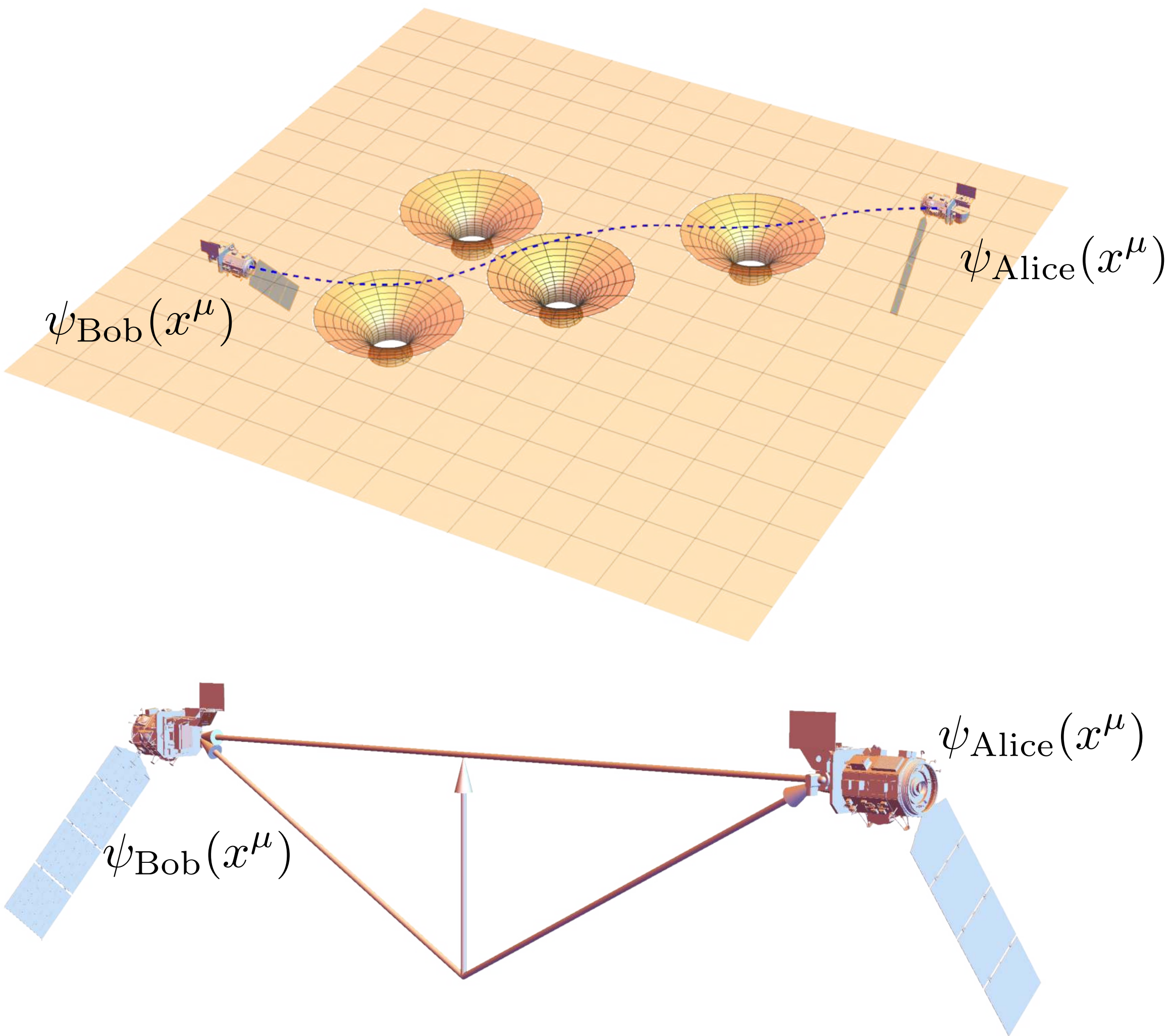

$$\psi_{\text{Bob}}(x^\mu) \simeq \psi^{(0)}(x^\mu) + \epsilon \psi^{(1)}(x^\mu) + \dots$$

$$\square^{(0)} \psi^{(1)} = -R_{+\bar{a}+\bar{b}} x^{\bar{a}} x^{\bar{b}} \partial_-^2 \psi^{(0)}$$

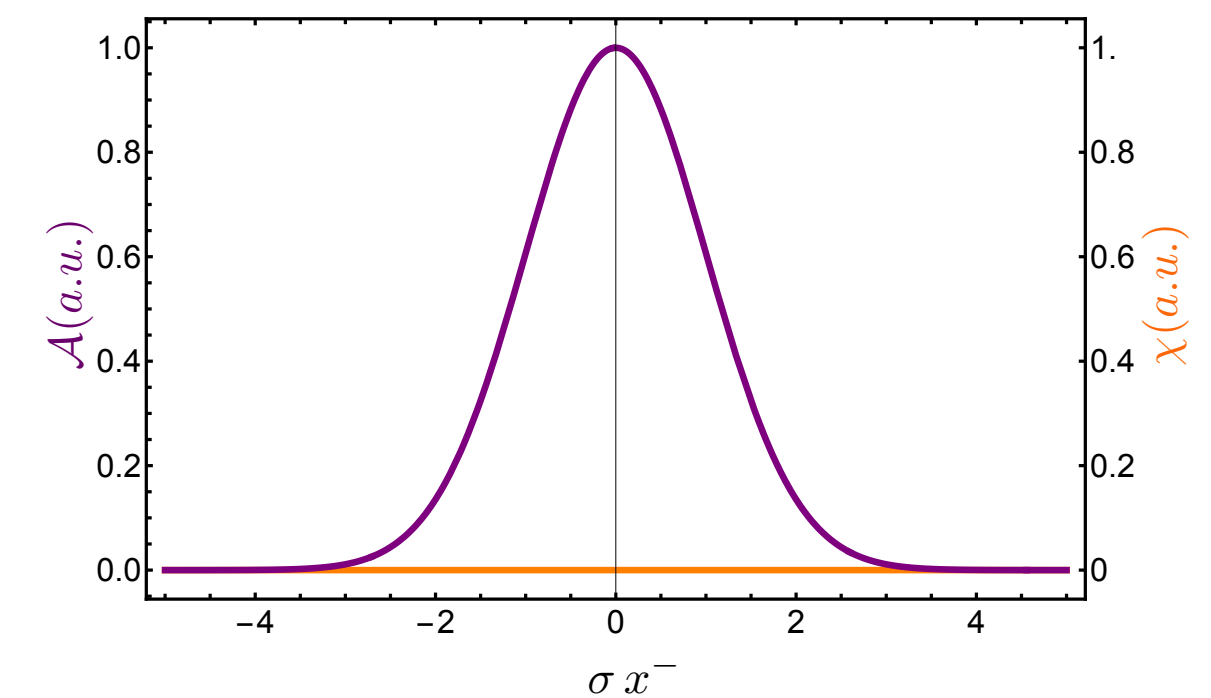
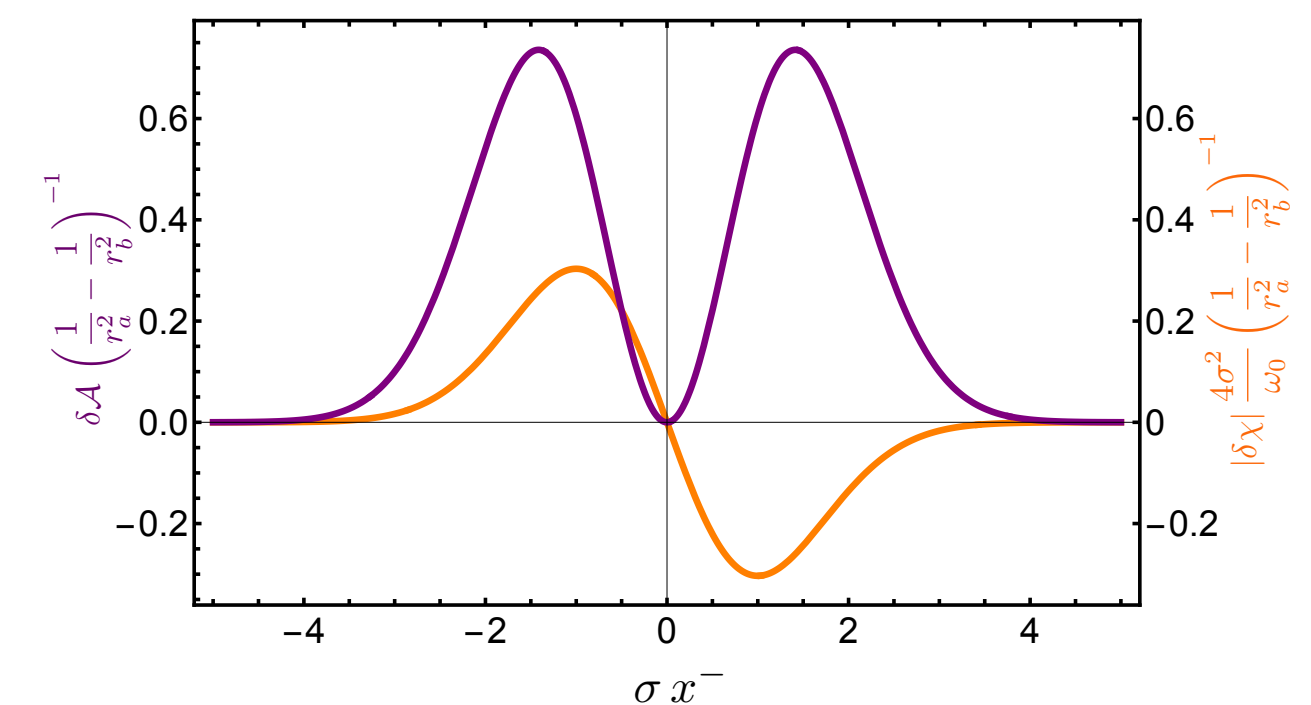

Structured Matter Waves

Elementary particles

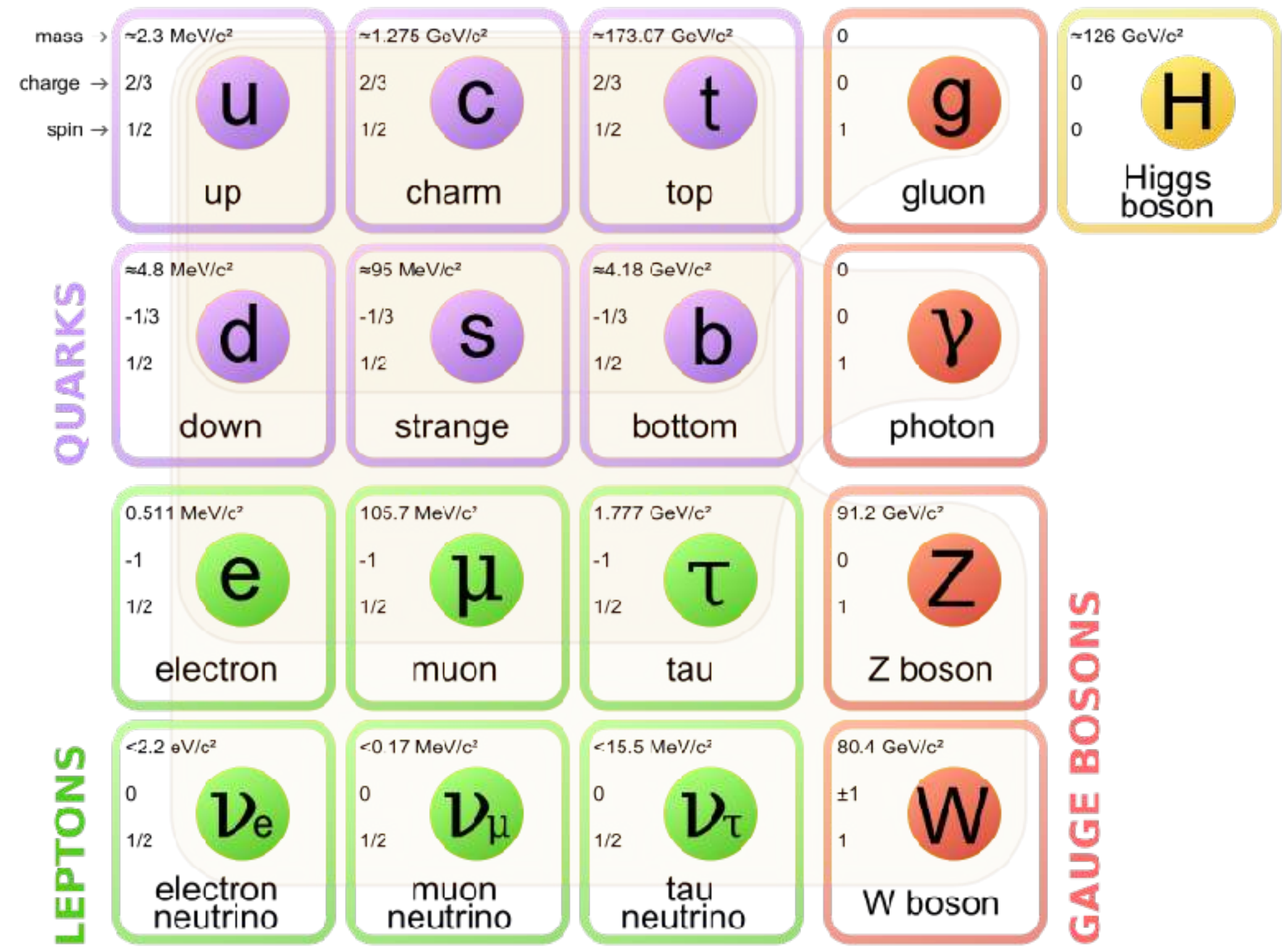

Elementary particles

	mass → $\approx 2.3 \text{ MeV}/c^2$ charge → $2/3$ spin → $1/2$ u up	mass → $\approx 1.275 \text{ GeV}/c^2$ charge → $2/3$ spin → $1/2$ c charm	mass → $\approx 173.07 \text{ GeV}/c^2$ charge → $2/3$ spin → $1/2$ t top	mass → 0 charge → 0 spin → 1 g gluon	mass → $\approx 126 \text{ GeV}/c^2$ charge → 0 spin → 0 H Higgs boson
QUARKS	mass → $\approx 4.8 \text{ MeV}/c^2$ charge → $-1/3$ spin → $1/2$ d down	mass → $\approx 95 \text{ MeV}/c^2$ charge → $-1/3$ spin → $1/2$ s strange	mass → $\approx 4.18 \text{ GeV}/c^2$ charge → $-1/3$ spin → $1/2$ b bottom	mass → 0 charge → 0 spin → 1 γ photon	
	mass → $0.511 \text{ MeV}/c^2$ charge → -1 spin → $1/2$ e electron	mass → $105.7 \text{ MeV}/c^2$ charge → -1 spin → $1/2$ μ muon	mass → $1.777 \text{ GeV}/c^2$ charge → -1 spin → $1/2$ τ tau	mass → $91.2 \text{ GeV}/c^2$ charge → 0 spin → 1 Z Z boson	
LEPTONS	mass → $< 2.2 \text{ eV}/c^2$ charge → 0 spin → $1/2$ ν_e electron neutrino	mass → $< 0.17 \text{ MeV}/c^2$ charge → 0 spin → $1/2$ ν_μ muon neutrino	mass → $< 15.5 \text{ MeV}/c^2$ charge → 0 spin → $1/2$ ν_τ tau neutrino	mass → $80.4 \text{ GeV}/c^2$ charge → ± 1 spin → 1 W W boson	GAUGE BOSONS

» An elementary particle

$$m_e = 9.10 \times 10^{-31} \text{ kg}$$

$$e = -1.6 \times 10^{-19} \text{ C}$$

$$|S| = \frac{1}{2}$$



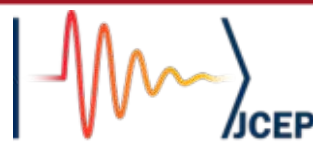

Structured Massive Particles

$\psi(\mathbf{r}; t)$ Wavefunction



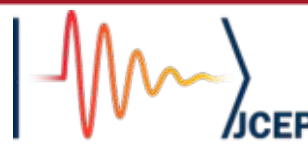

Structured Massive Particles

$\psi(\mathbf{r}; t)$ Wavefunction

relativistic $(i\hbar\gamma^\mu\partial_\mu - mc)\psi(\mathbf{r}; t) = 0$



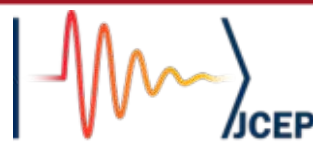

Structured Massive Particles

$\psi(\mathbf{r}; t)$ Wavefunction

non-relativistic $-\frac{\hbar^2}{2m} \nabla^2 \psi(\mathbf{r}; t) = i\hbar \partial_t \psi(\mathbf{r}; t)$



Structured Massive Particles

$\psi(\mathbf{r}; t)$ Wavefunction

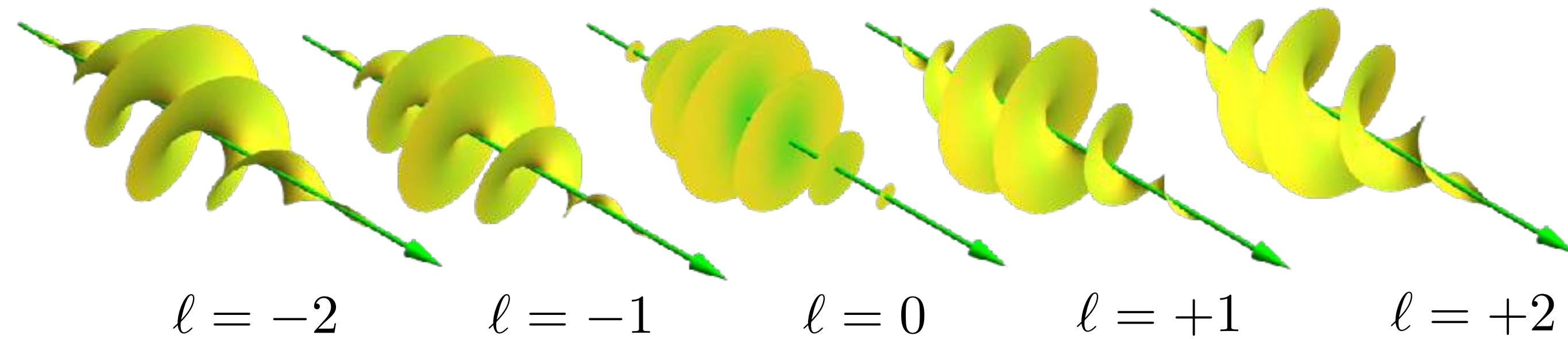

non-relativistic $-\frac{\hbar^2}{2m} \nabla^2 \psi(\mathbf{r}; t) = i\hbar \partial_t \psi(\mathbf{r}; t)$

$$\phi_{\ell,p,n}(r, \varphi, z; t) = \psi_{\ell,p}^{\text{LG}}(r, \varphi; t) u_n^{\text{HG}}(z - (p_0/m_e)t)$$



Structured Massive Particles

$\psi(\mathbf{r}; t)$ Wavefunction

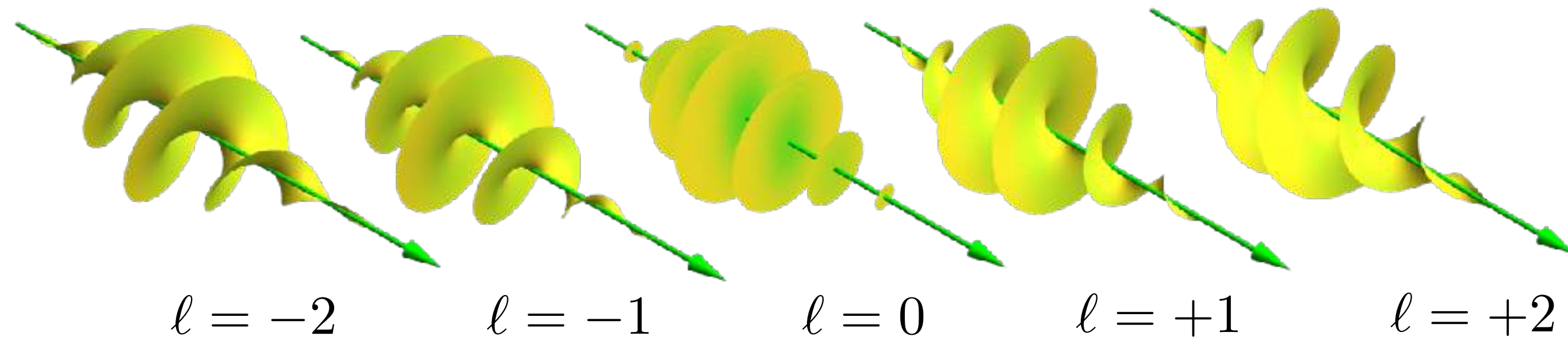

non-relativistic $-\frac{\hbar^2}{2m} \nabla^2 \psi(\mathbf{r}; t) = i\hbar \partial_t \psi(\mathbf{r}; t)$

$$\phi_{\ell,p,n}(r, \varphi, z; t) = \psi_{\ell,p}^{\text{LG}}(r, \varphi; t) u_n^{\text{HG}}(z - (p_0/m_e)t)$$

azimuthal \uparrow radial \uparrow longitudinal index
 transverse indices

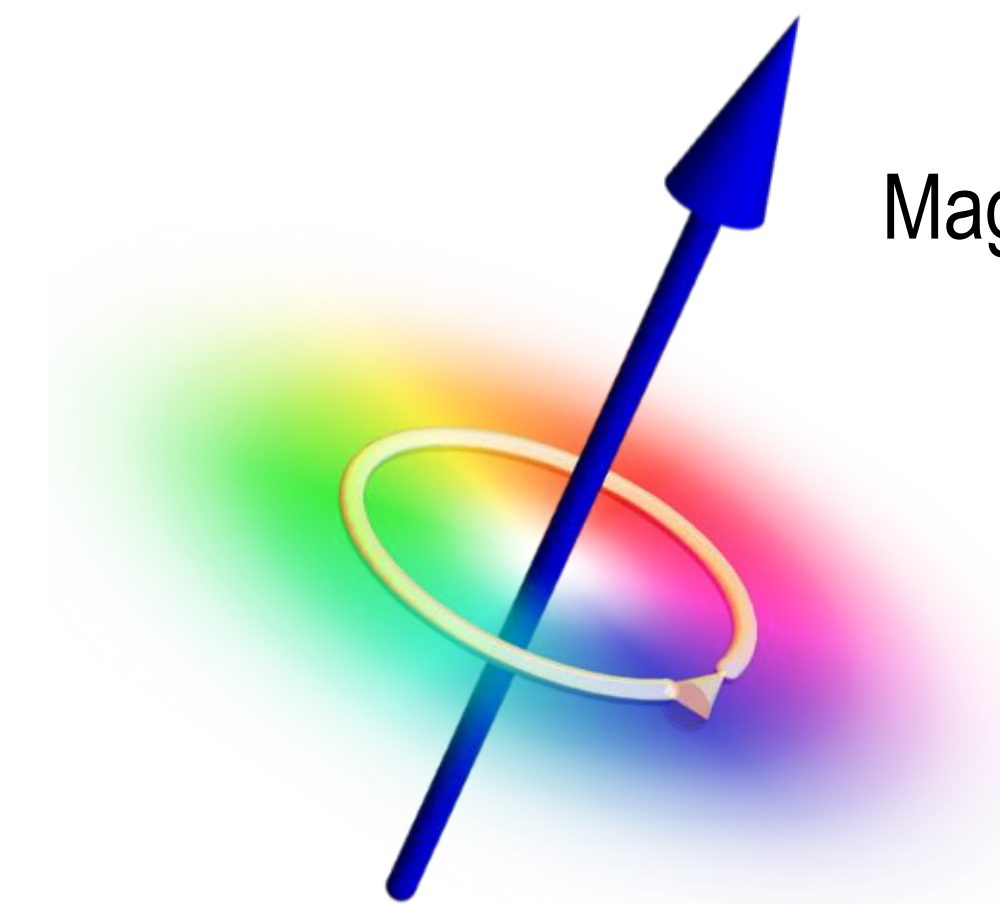

Magnetic dipole

$$\mu = \frac{e\hbar}{2m} \ell \hat{\mathbf{z}}$$



Structured Electrons

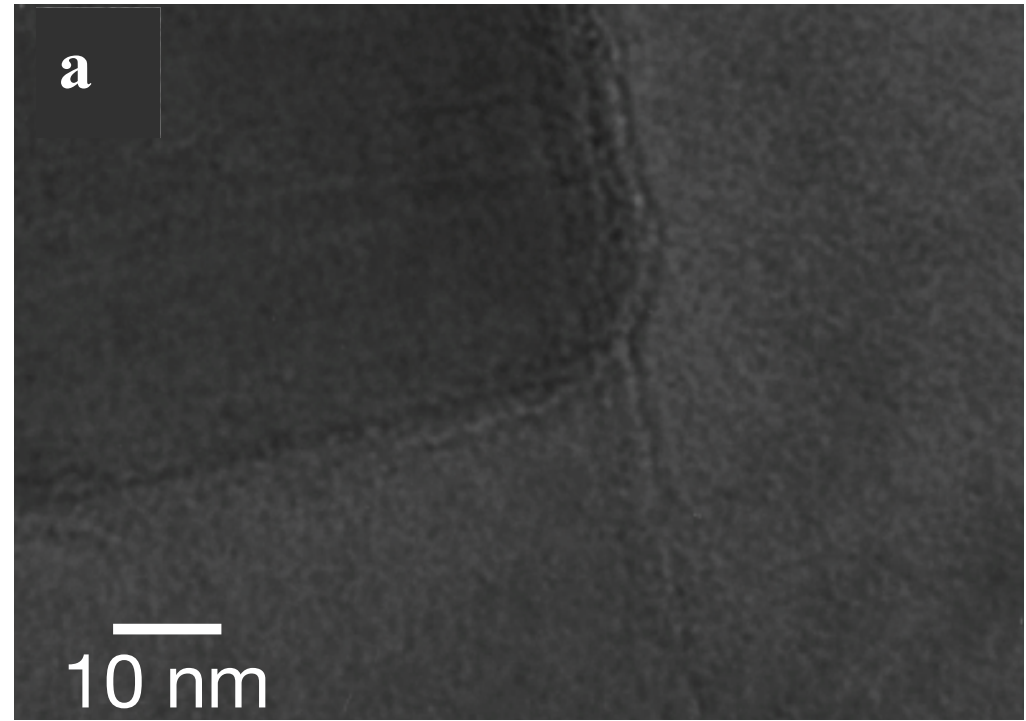

Uchida & Tonomura *Nature* **464**, 737 (2010).

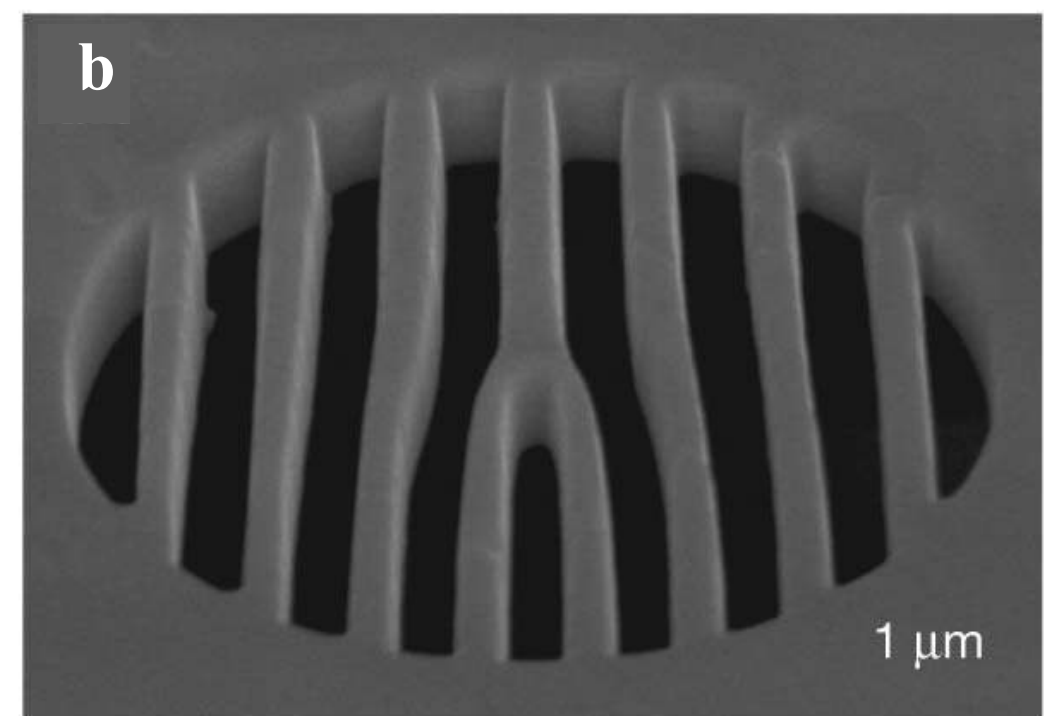

Verbeeck *et al.*, *Nature* **467**, 301 (2010).

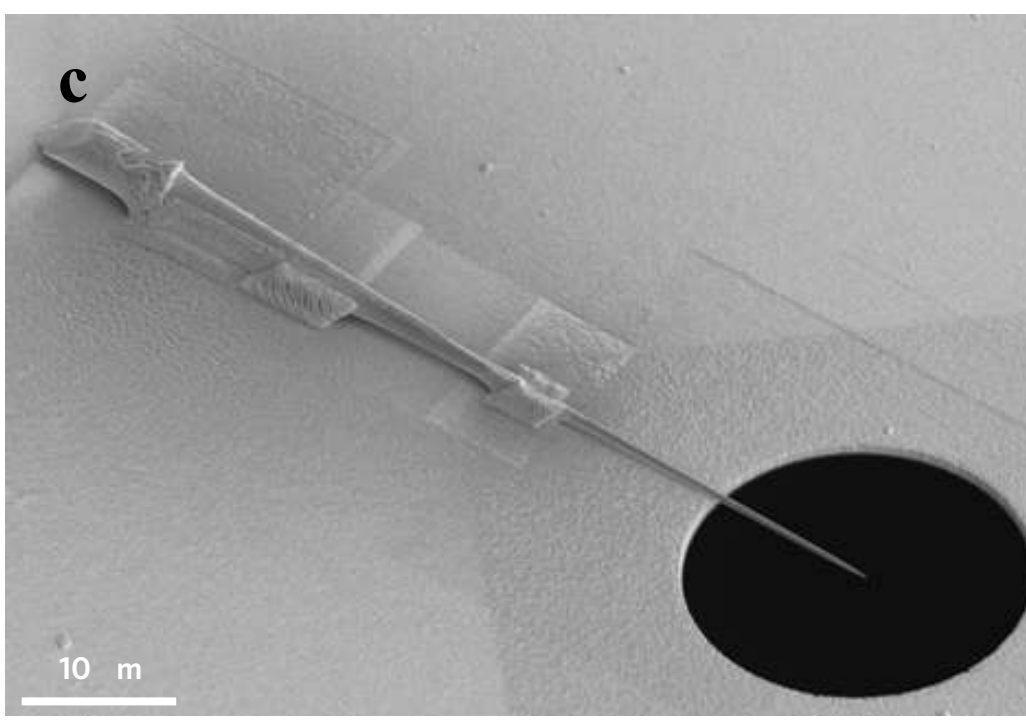

Béché *et al.*, *Nat. Phys.* **10**, 25 (2013).

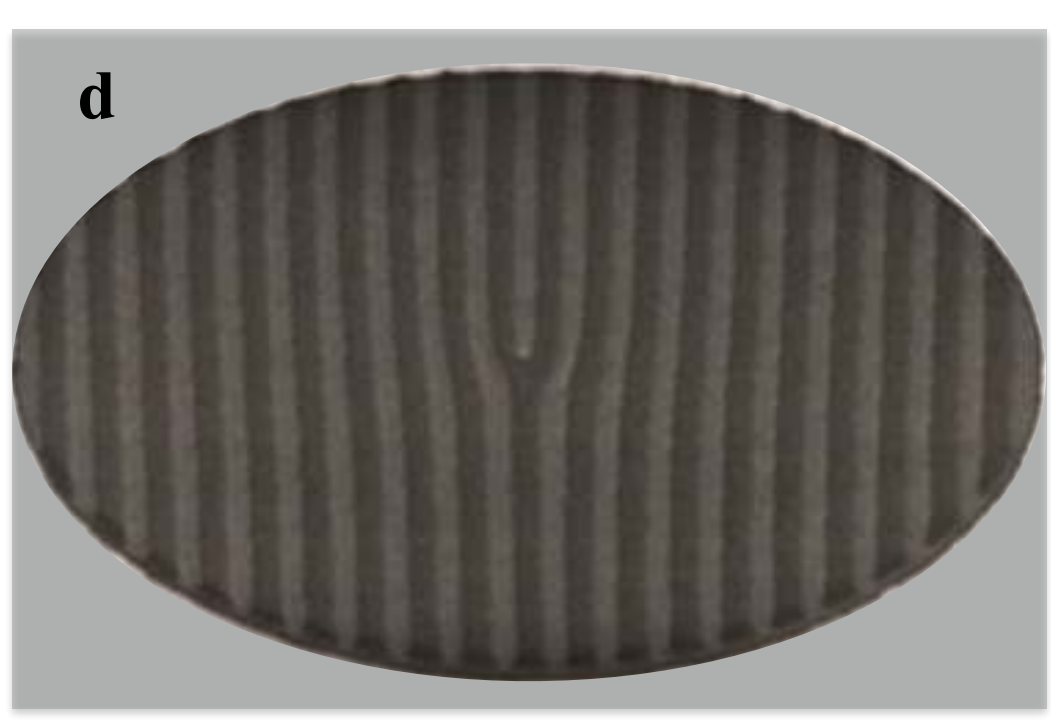

Grillo *et al.*, *Appl. Phys. Lett.* **104**, 043109 (2014).

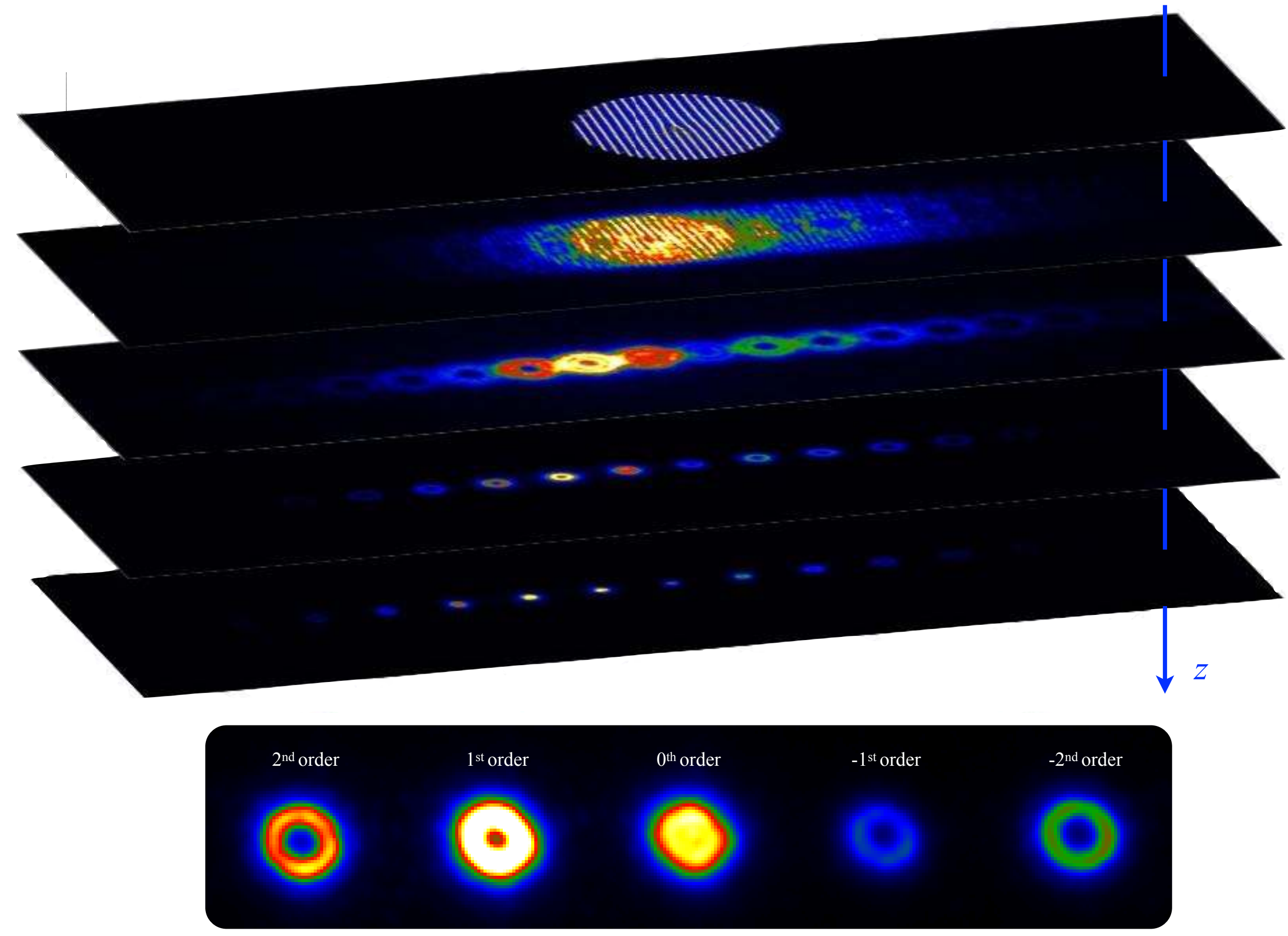

Structured Electrons: Applications

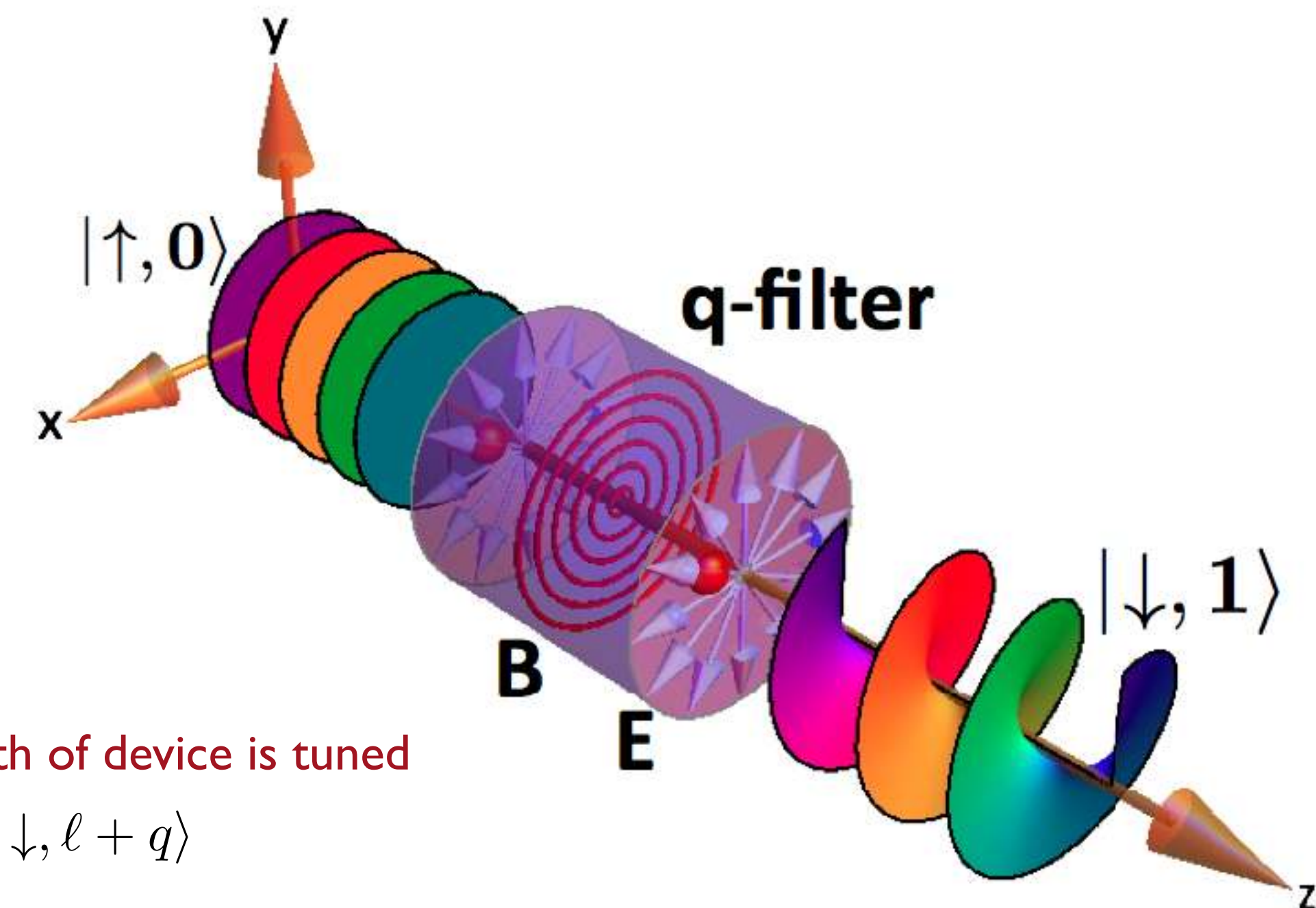
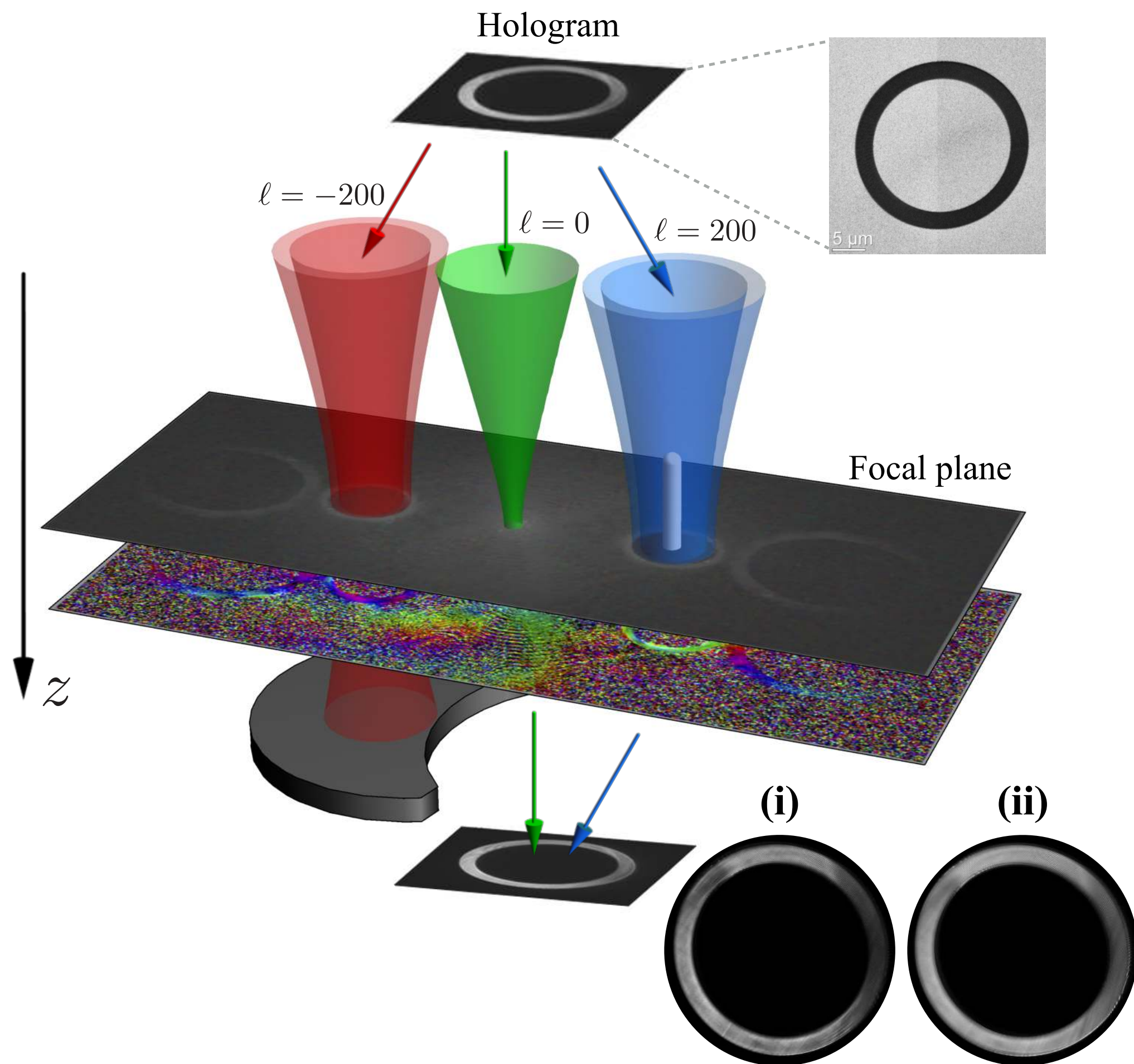

If the length of device is tuned

$$|\uparrow, \ell\rangle \rightarrow |\downarrow, \ell + q\rangle$$

a general expression

$$|\uparrow, \ell\rangle \rightarrow \cos(\delta/2)|\uparrow, \ell\rangle + i \sin(\delta/2)|\downarrow, \ell + q\rangle$$

$$|\downarrow, \ell\rangle \rightarrow \cos(\delta/2)|\downarrow, \ell\rangle + i \sin(\delta/2)|\uparrow, \ell - q\rangle$$

E.K., L Marrucci, V Grillo, E Santamato, *Physical Review Letters* **108**, 044801 (2012).

V Grillo, T R Harvey, F Venturi, J S Pierce, R Balboni, F Bouchard, G C Gazzadi, S Frabboni, A H Tavabi, Z-A Li, R E Dunin-Borkowski, R W Boyd, B J McMorran & E.K. *Nature Communications* **8**, 689 (2017).

J. Harris, V Grillo, E Mafakheri, G C Gazzadi, S Frabboni, R W Boyd & E.K., *Nature Physics* **11**, 629 (2015).

H Larocque, I Kaminer, V Grillo, G Leuchs, M J Padgett, R W Boyd, M Segev & E.K., *Contemporary Physics* **59**, 1 (2018).



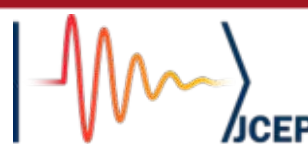

Generation: Holographic Technique

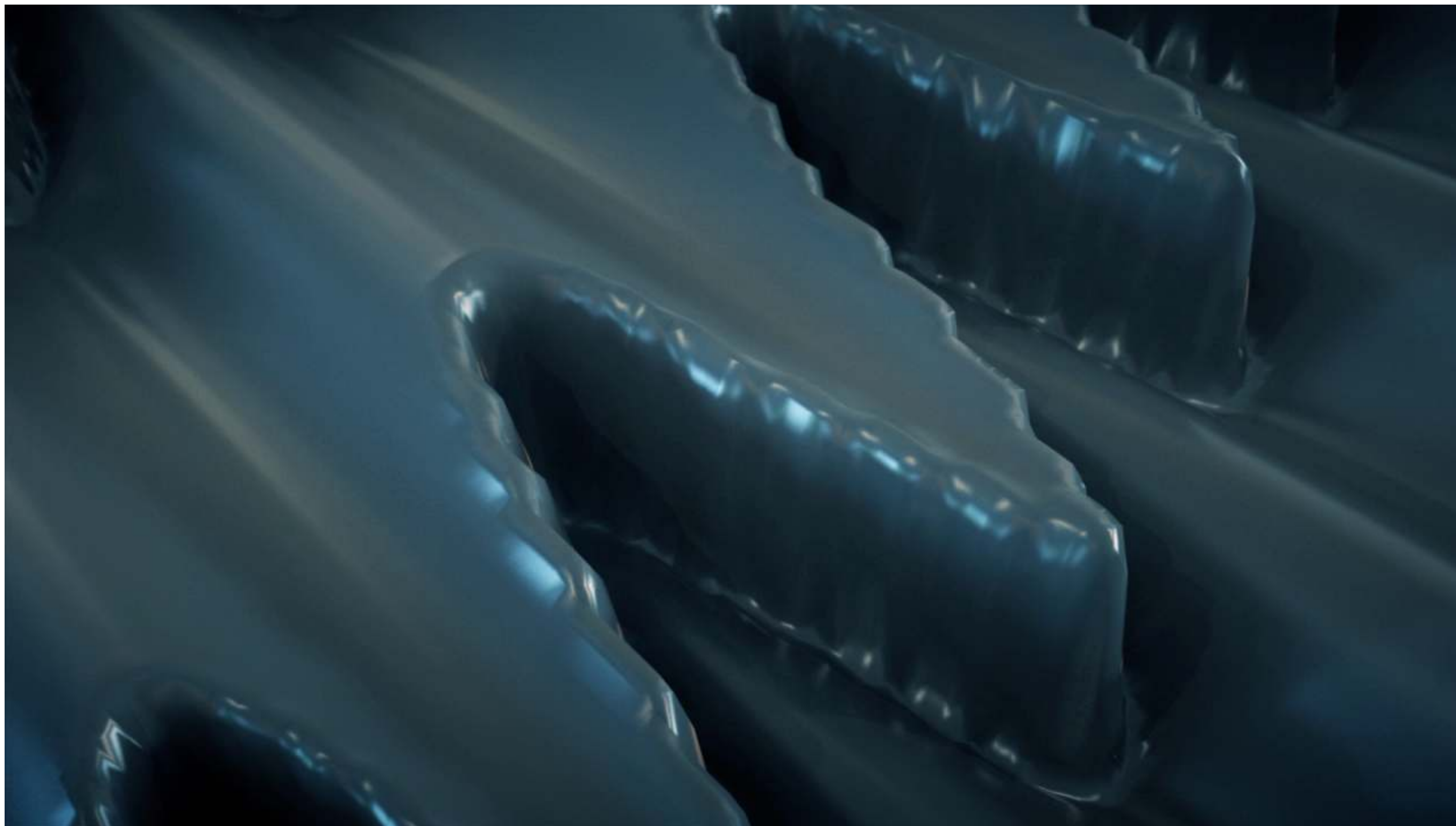

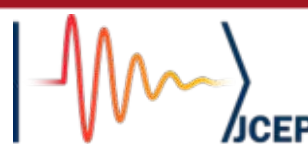

Generation: Holographic Technique

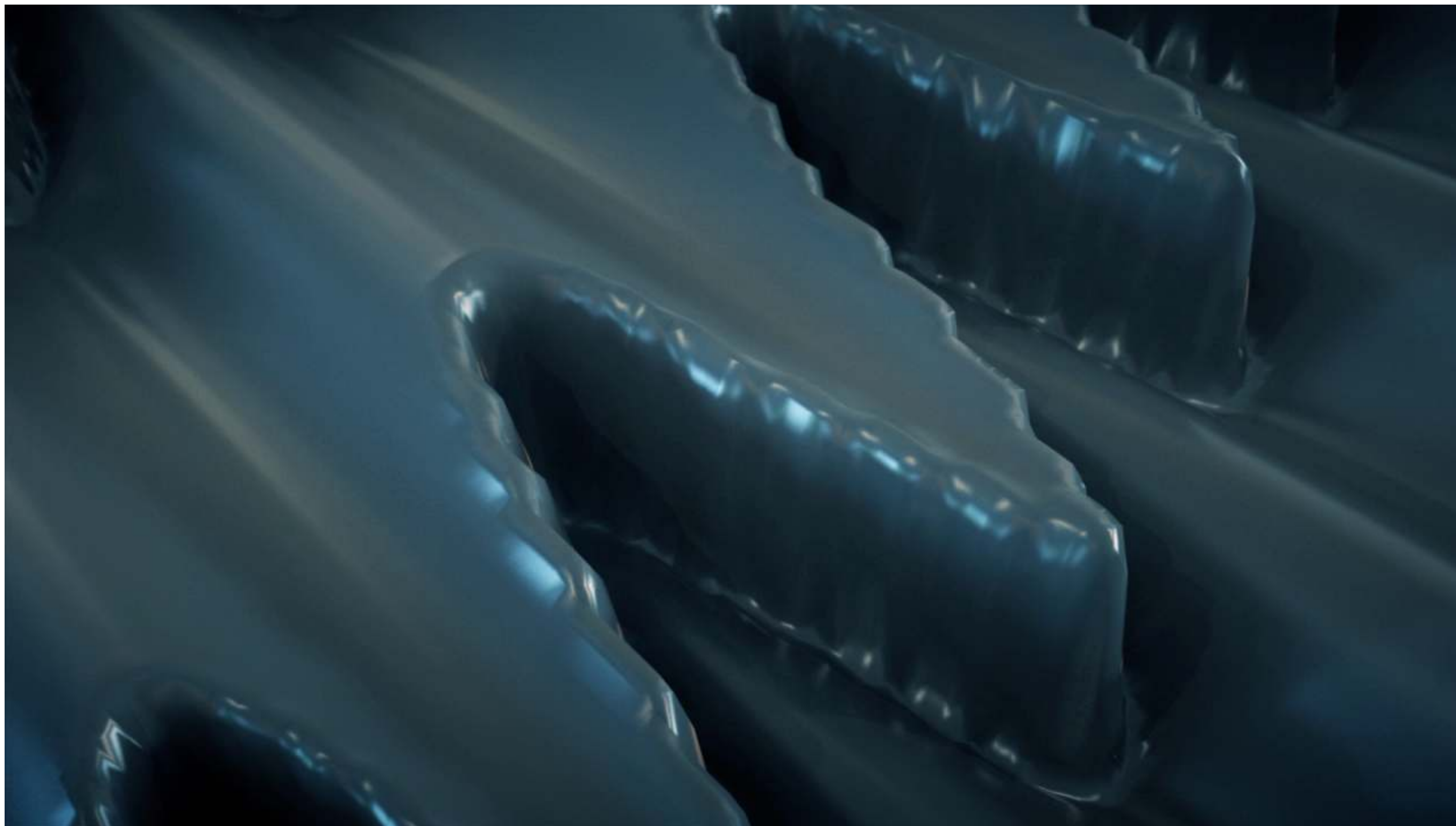

Dynamic Generation

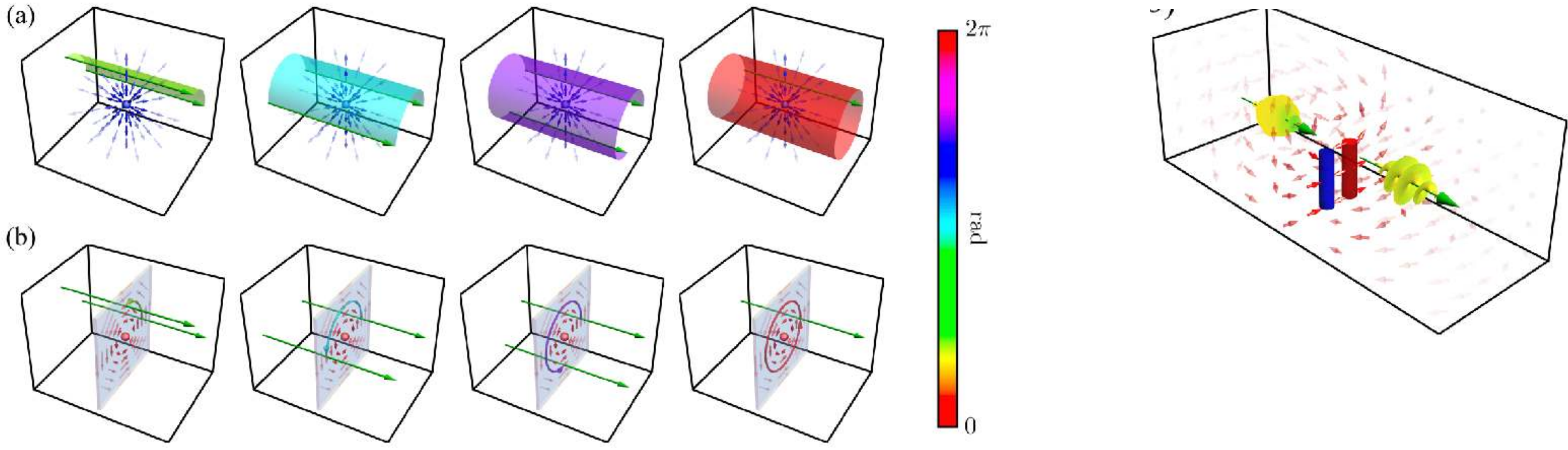

Dynamic Generation

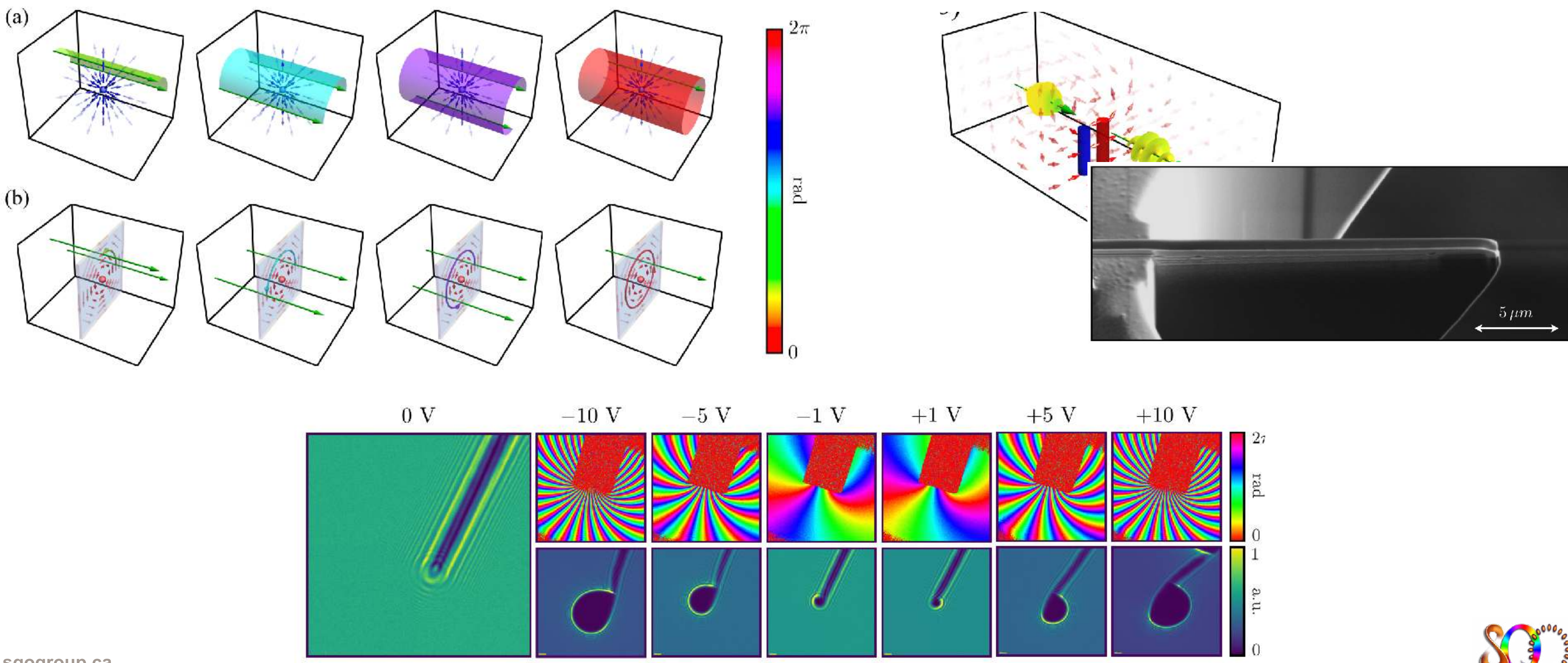

Attosecond generation of Twisted electrons

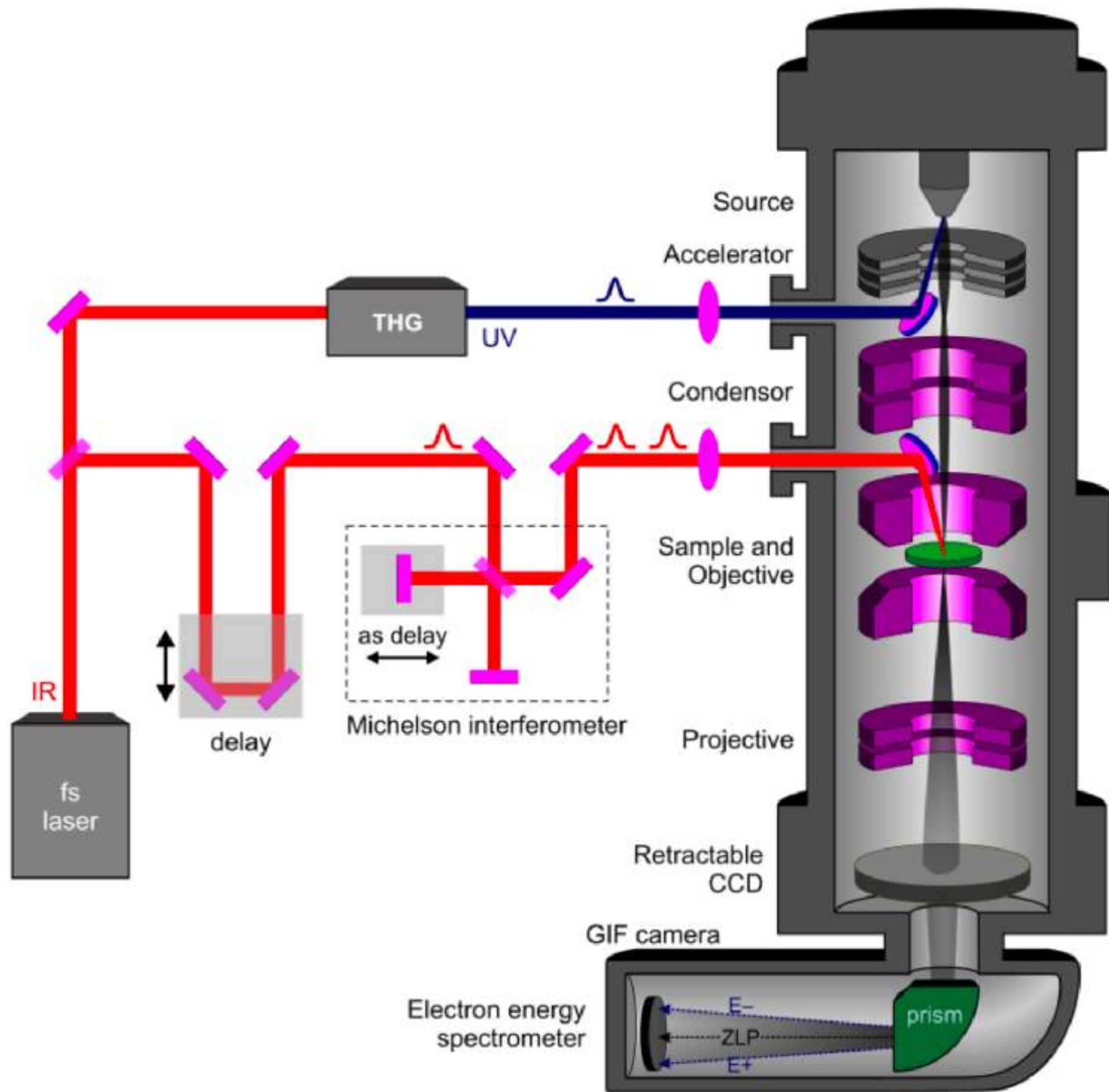

Attosecond generation of Twisted electrons

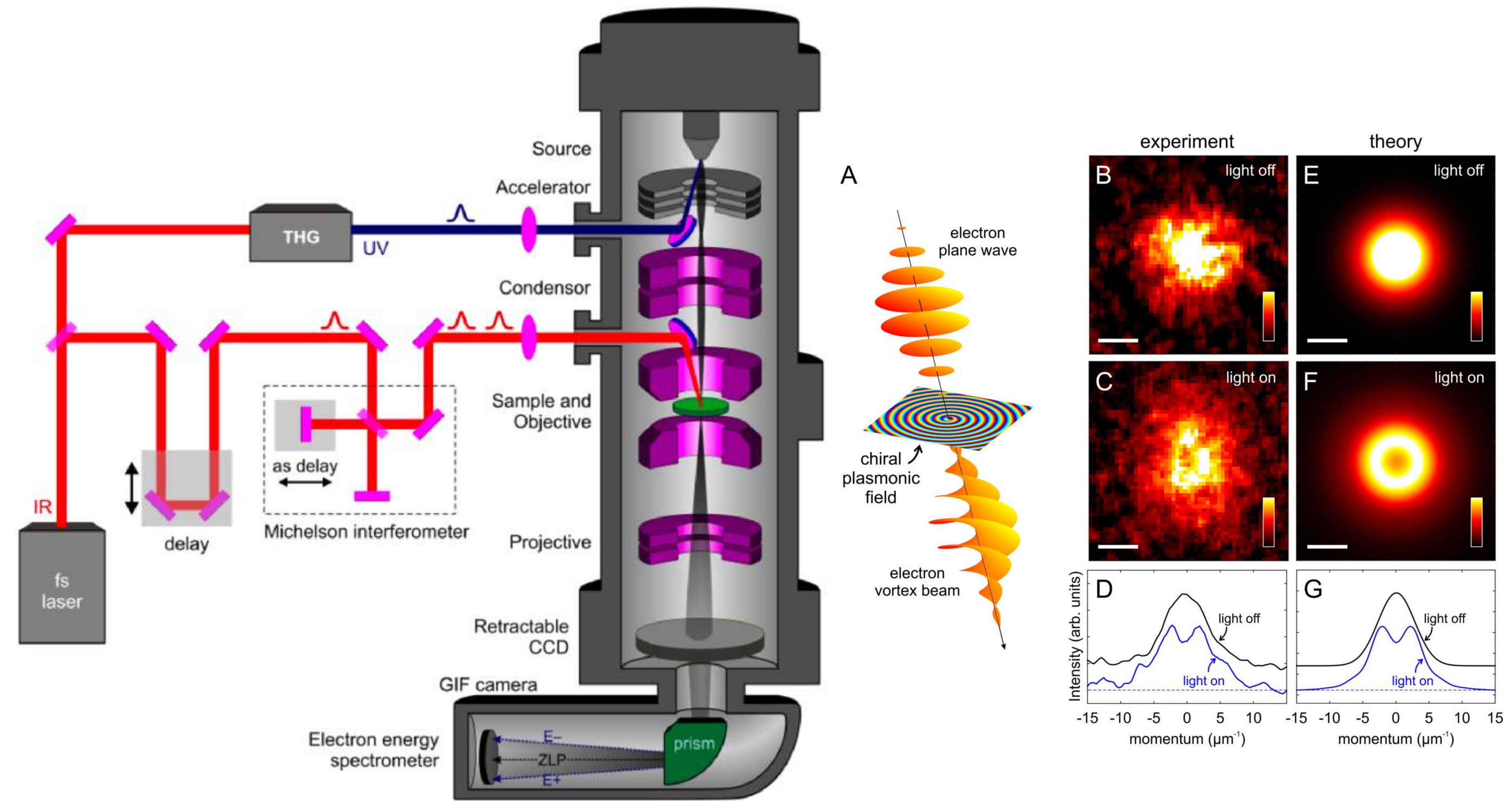

Attosecond generation of Twisted electrons

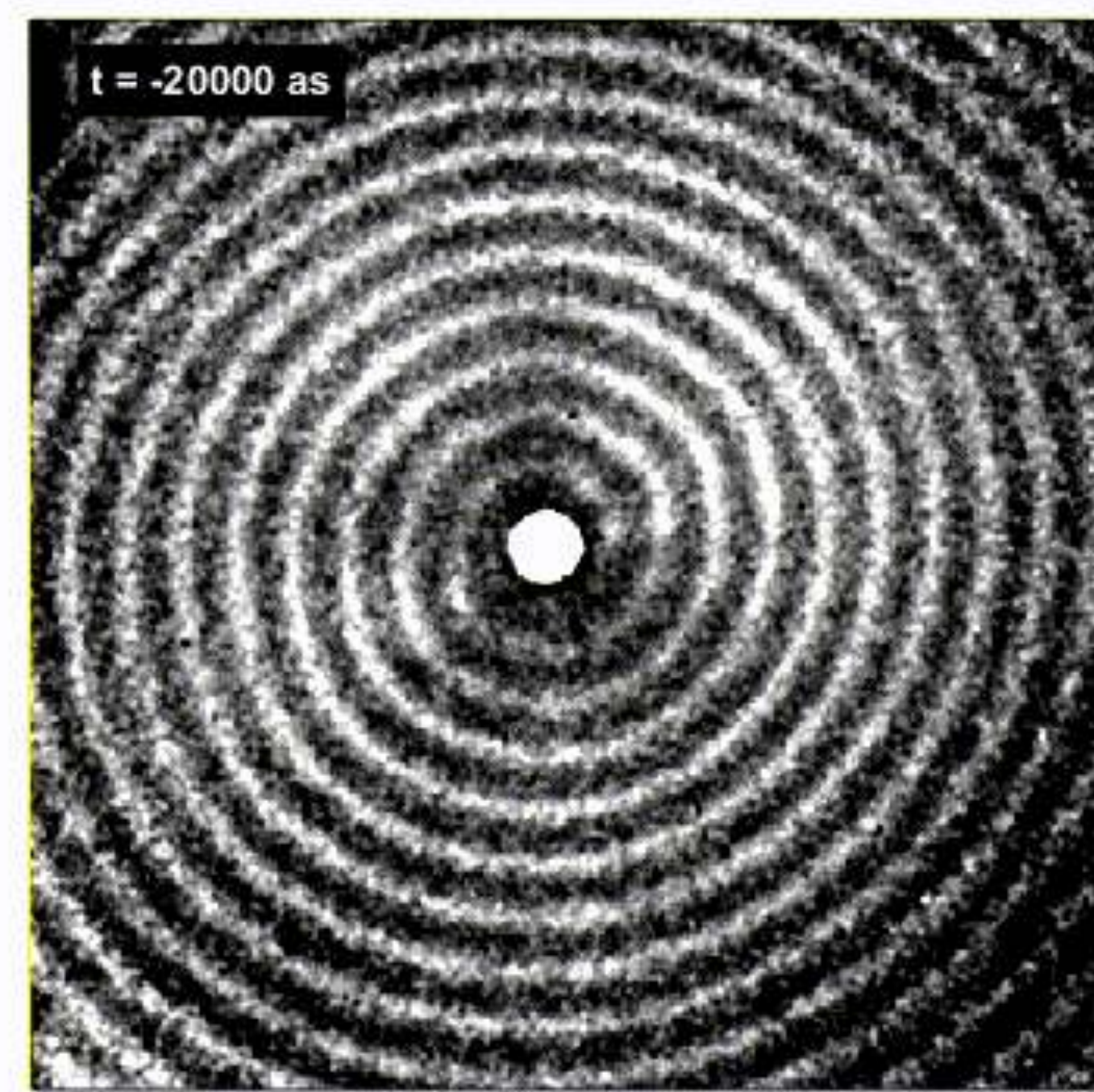
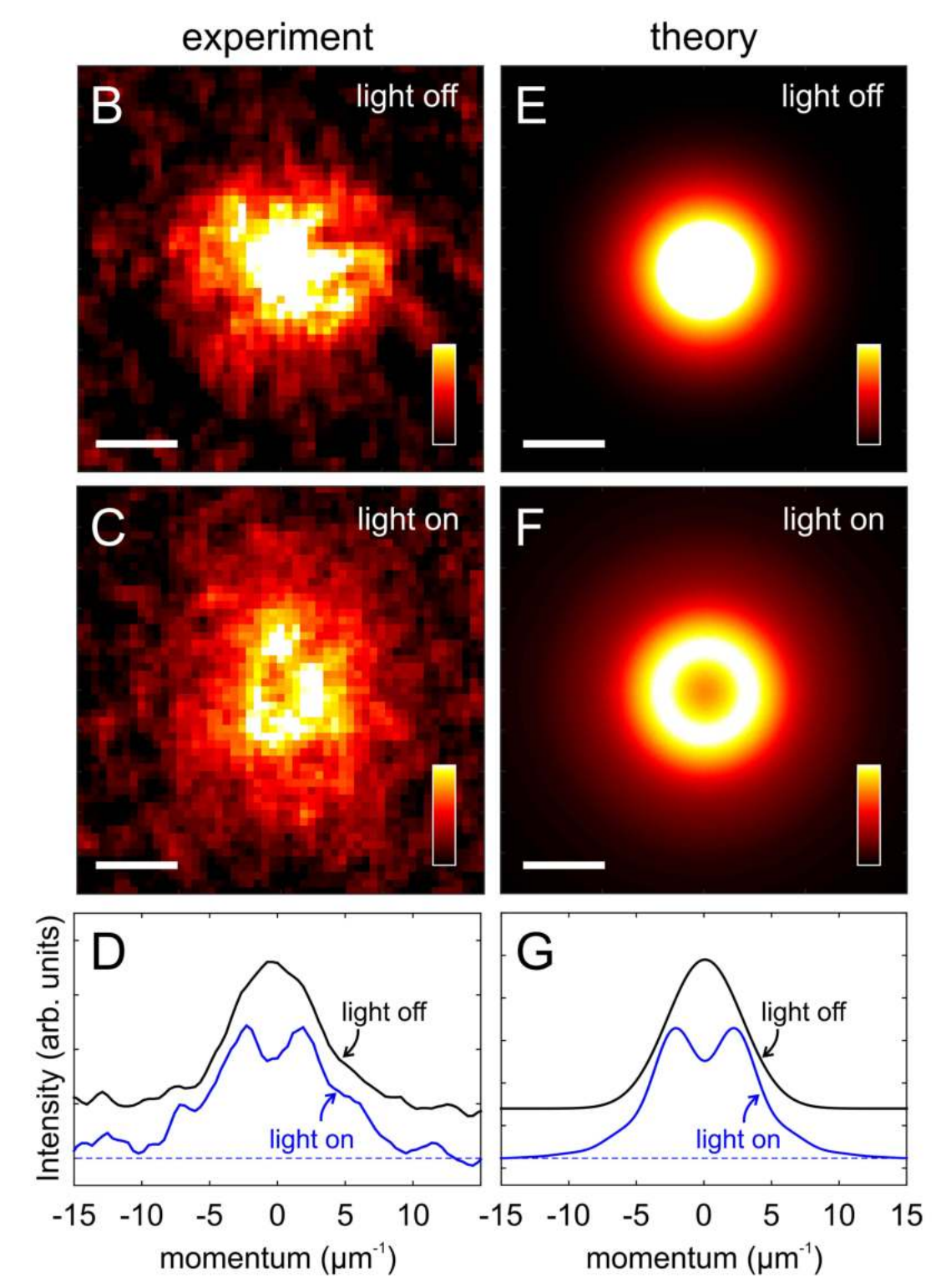
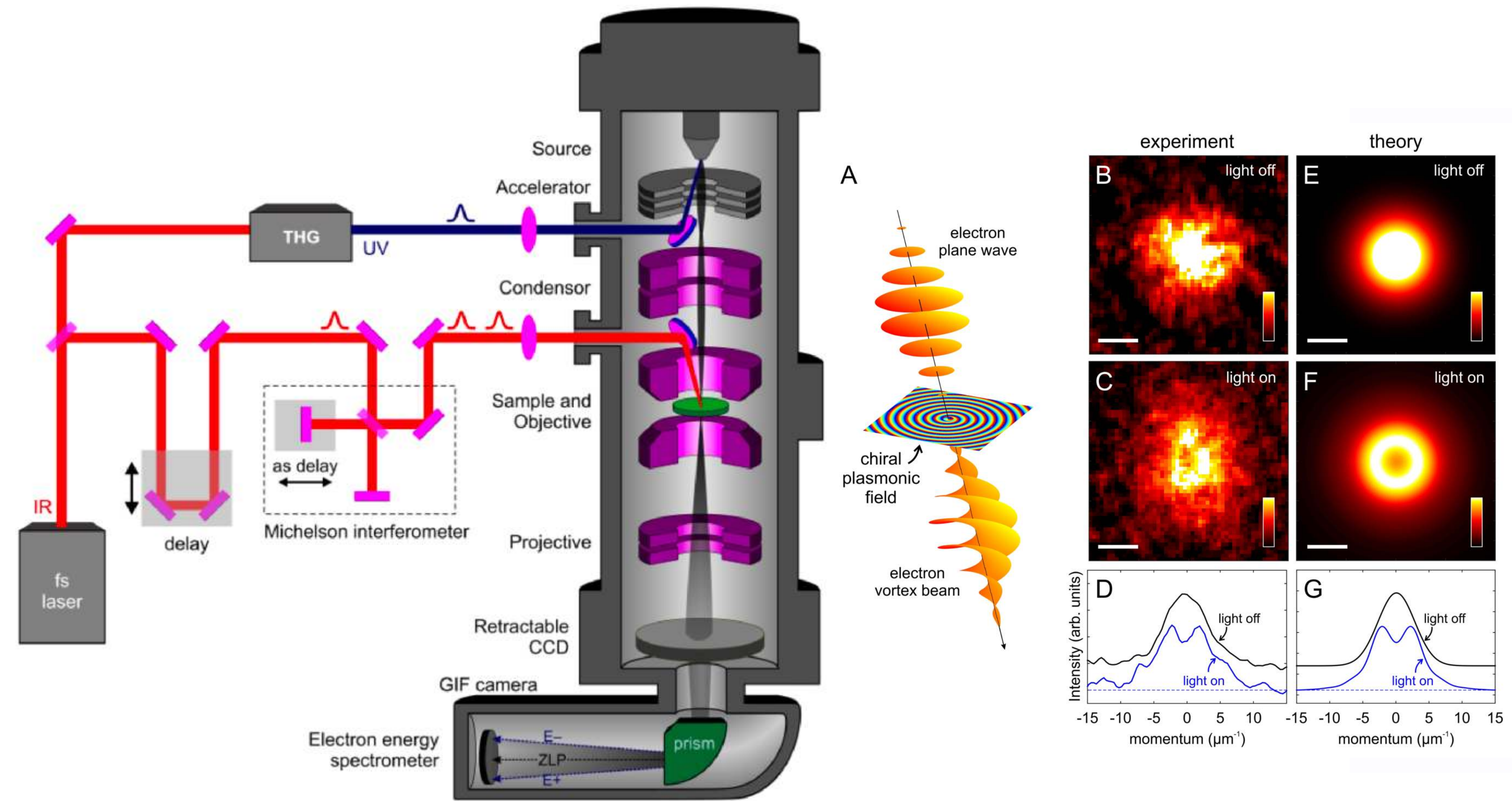

Protein recognition

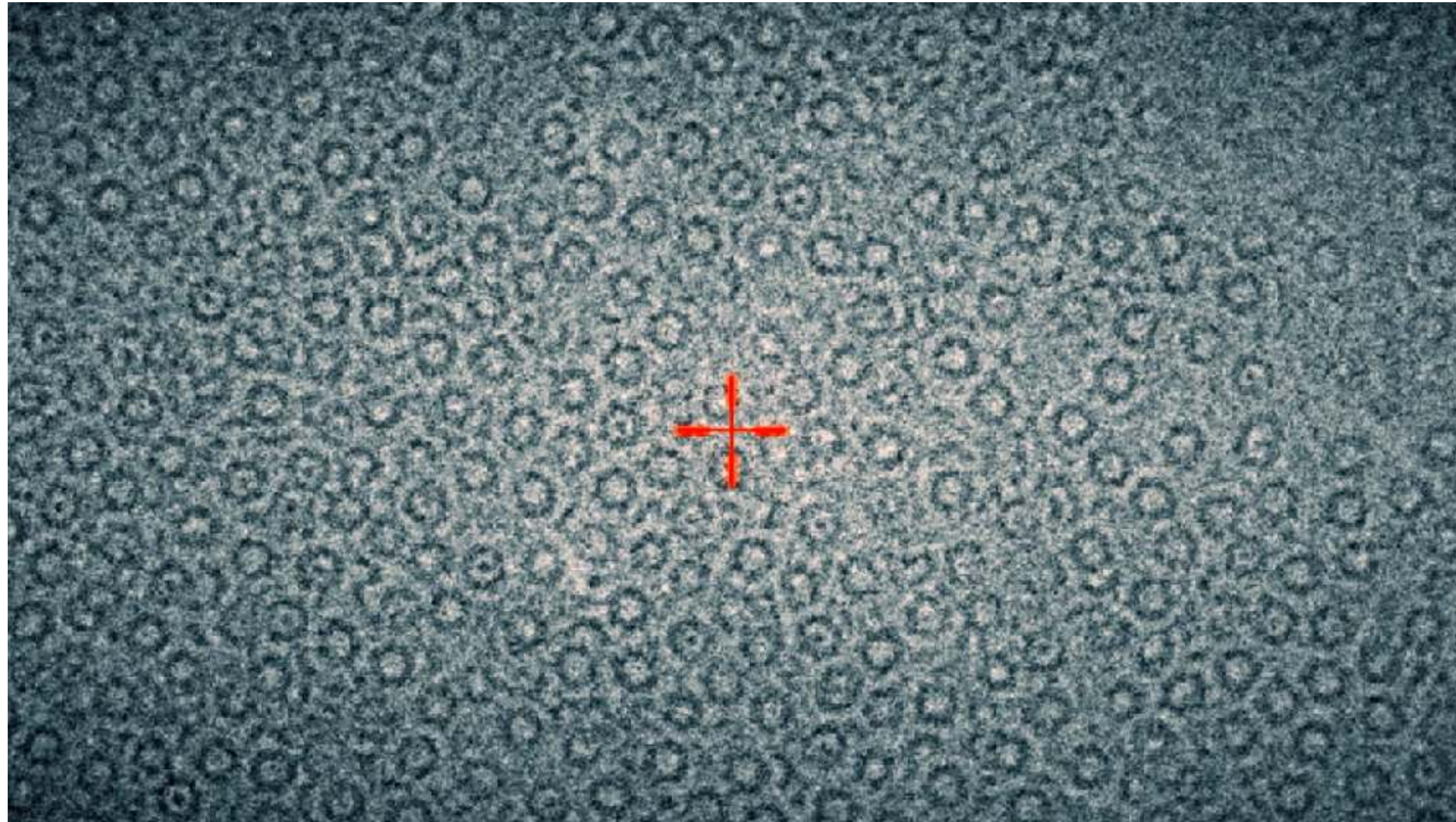

EspB protein of *Mycobacterium tuberculosis*

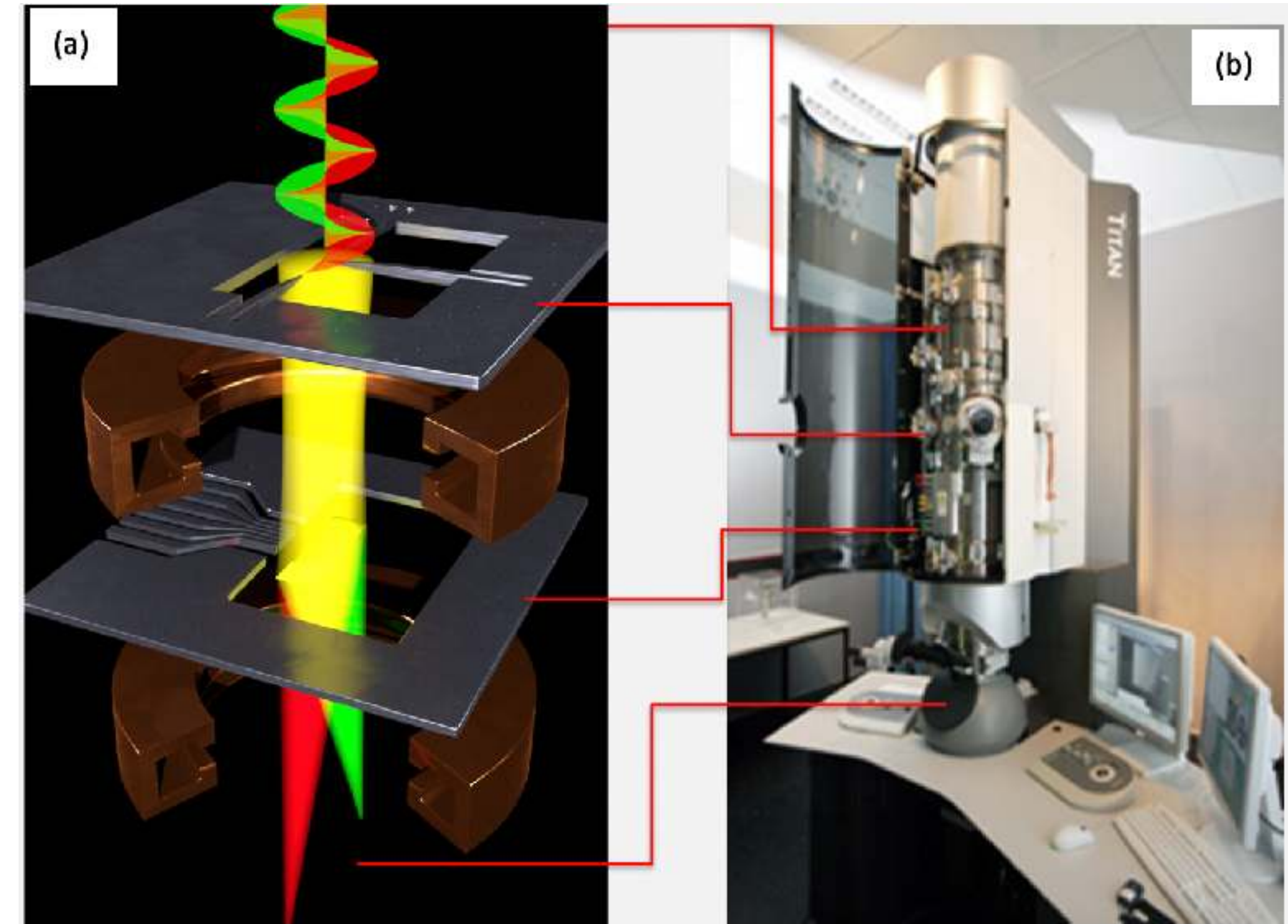

AH Tavabi, P Rosi, E Rotunno, A Roncaglia, L Belsito, S Frabboni, G Pozzi, G C Gazzadi, P-H Lu, R Nijland, M Ghosh, P Tiemeijer, E. K., R E Dunin-Borkowski, V. Grillo Physical Review Letters **126**, 094802 (2021).

Protein recognition

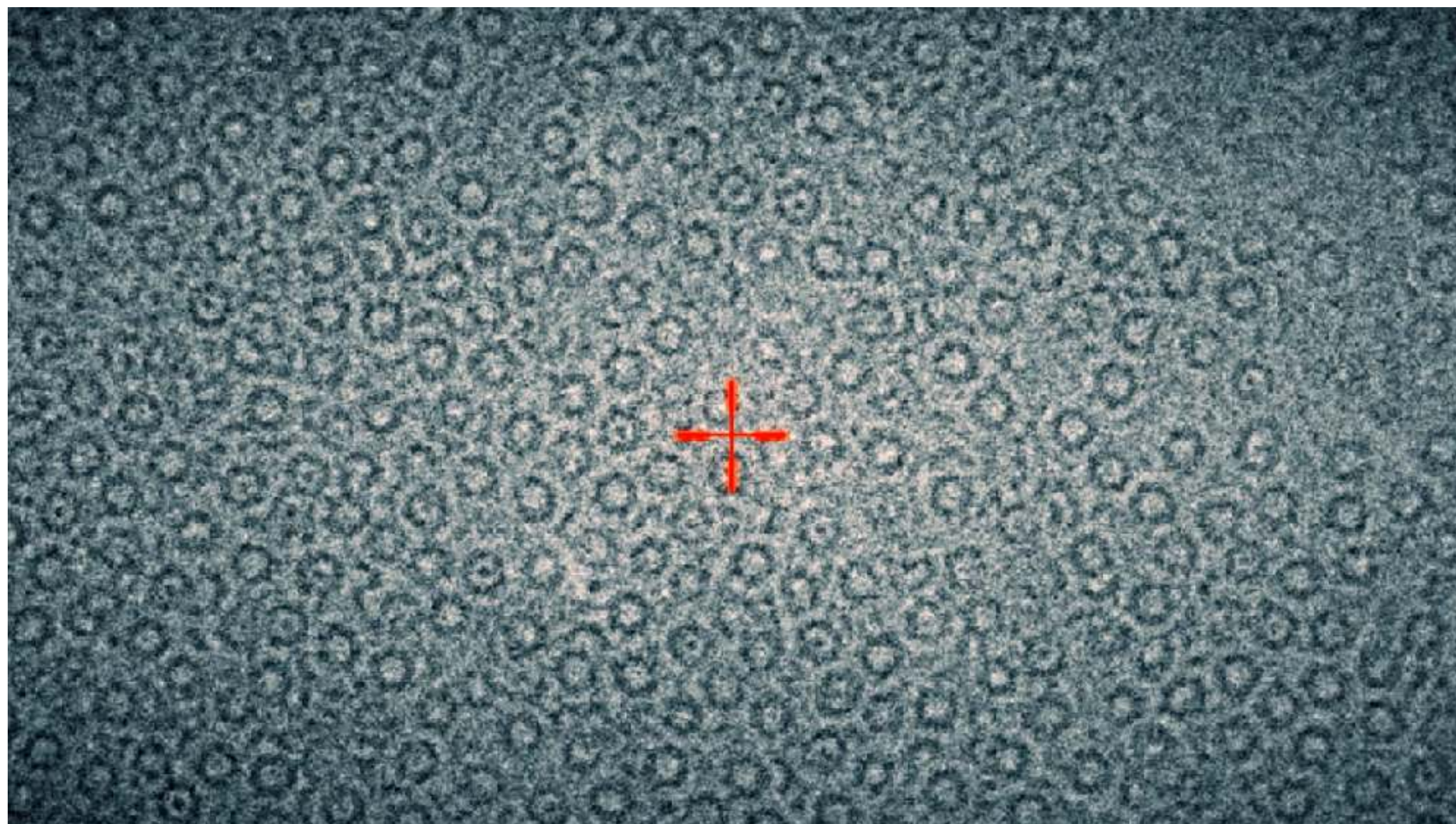

EspB protein of *Mycobacterium tuberculosis*

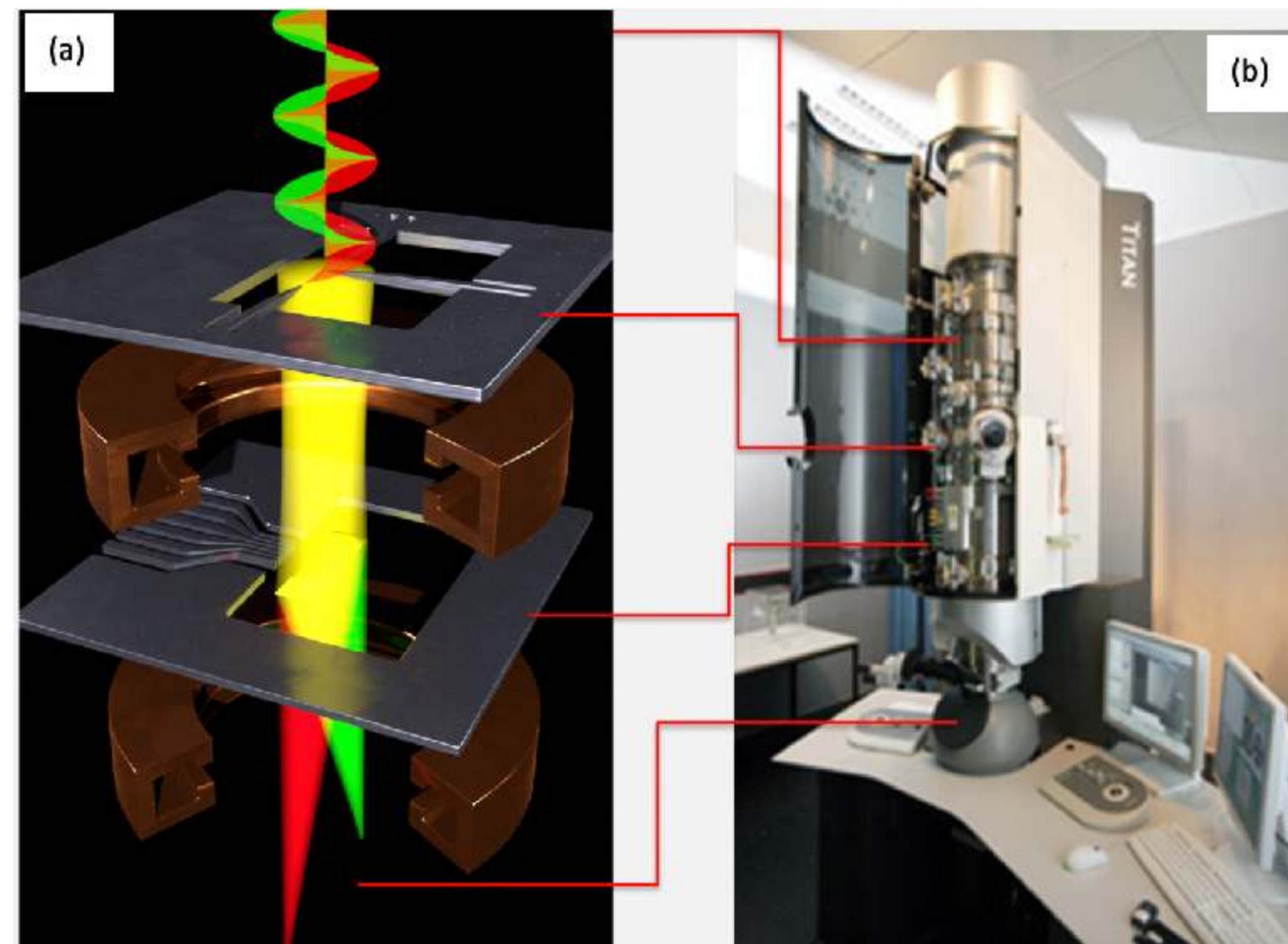

AH Tavabi, P Rosi, E Rotunno, A Roncaglia, L Belsito, S Frabboni, G Pozzi, G C Gazzadi, P-H Lu, R Nijland, M Ghosh, P Tiemeijer, E. K., R E Dunin-Borkowski, V. Grillo Physical Review Letters **126**, 094802 (2021).

Electron sorter

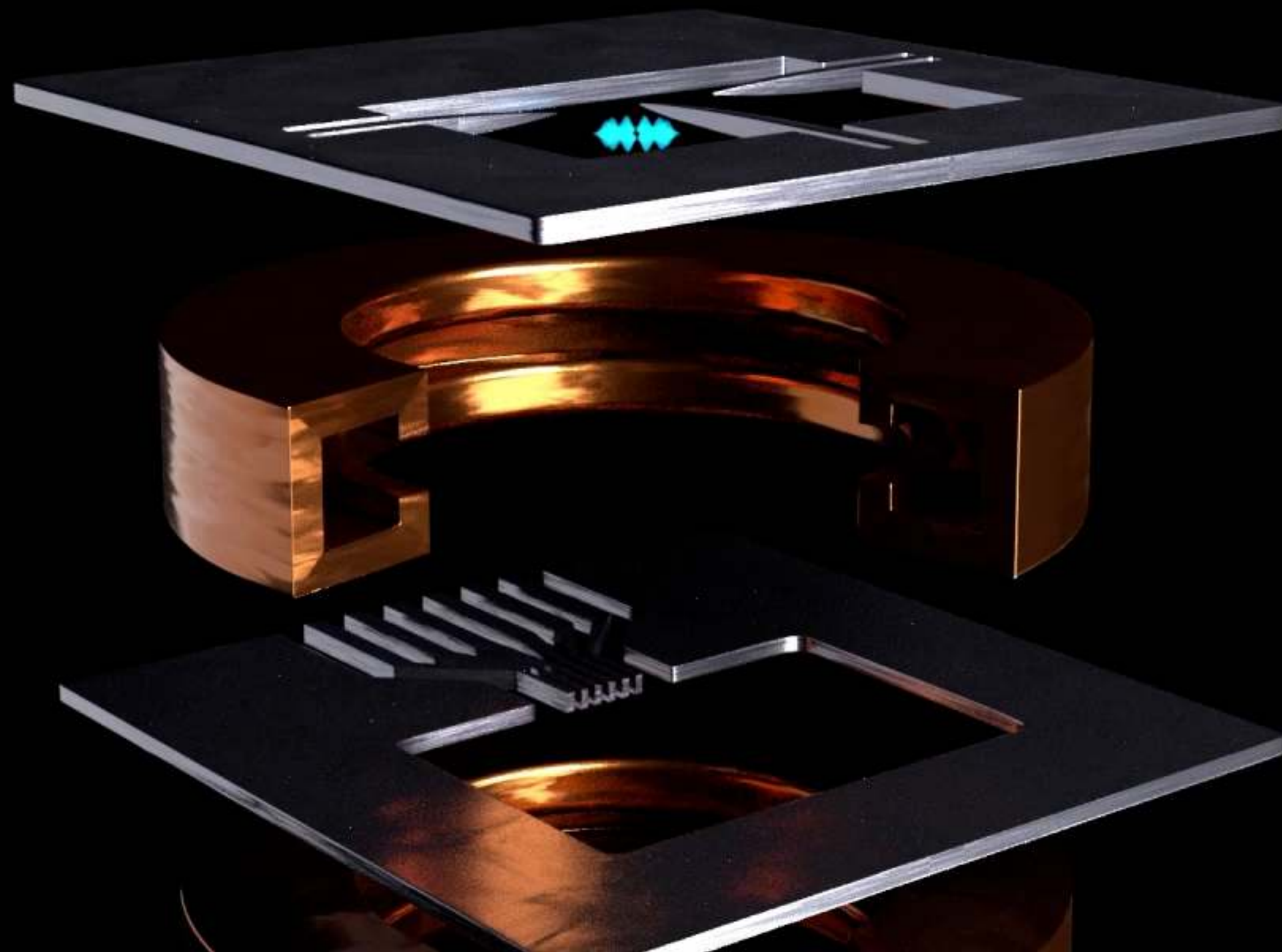

Electron sorter

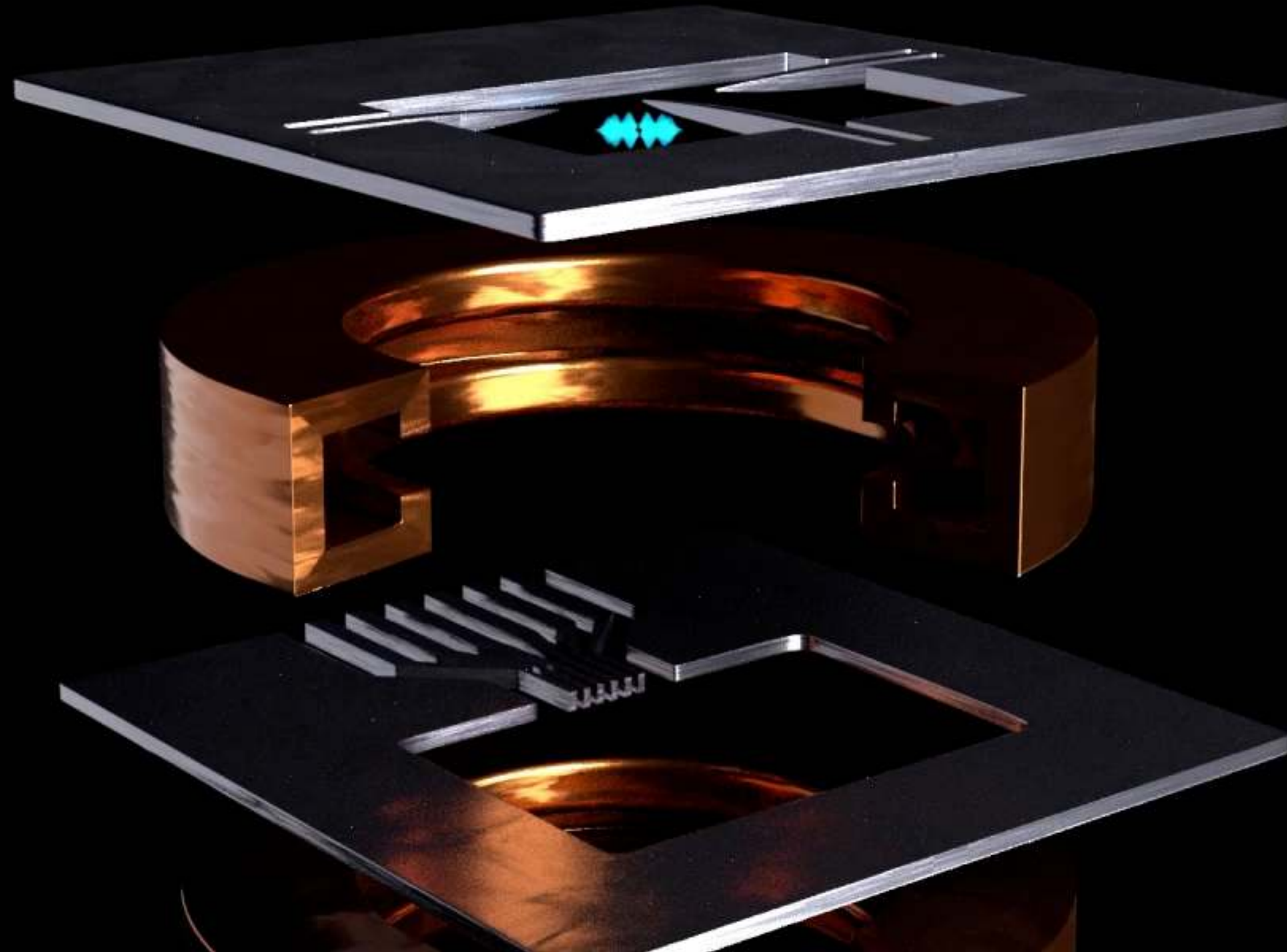

Neutrons

$$\rho(r) = \frac{1}{2\pi} \int_0^\infty q dq \left(\frac{4m_n G_E(q^2) + q^2 G_M(q^2)}{4m_n + q^2} \right) J_0(qr)$$

Form Factors

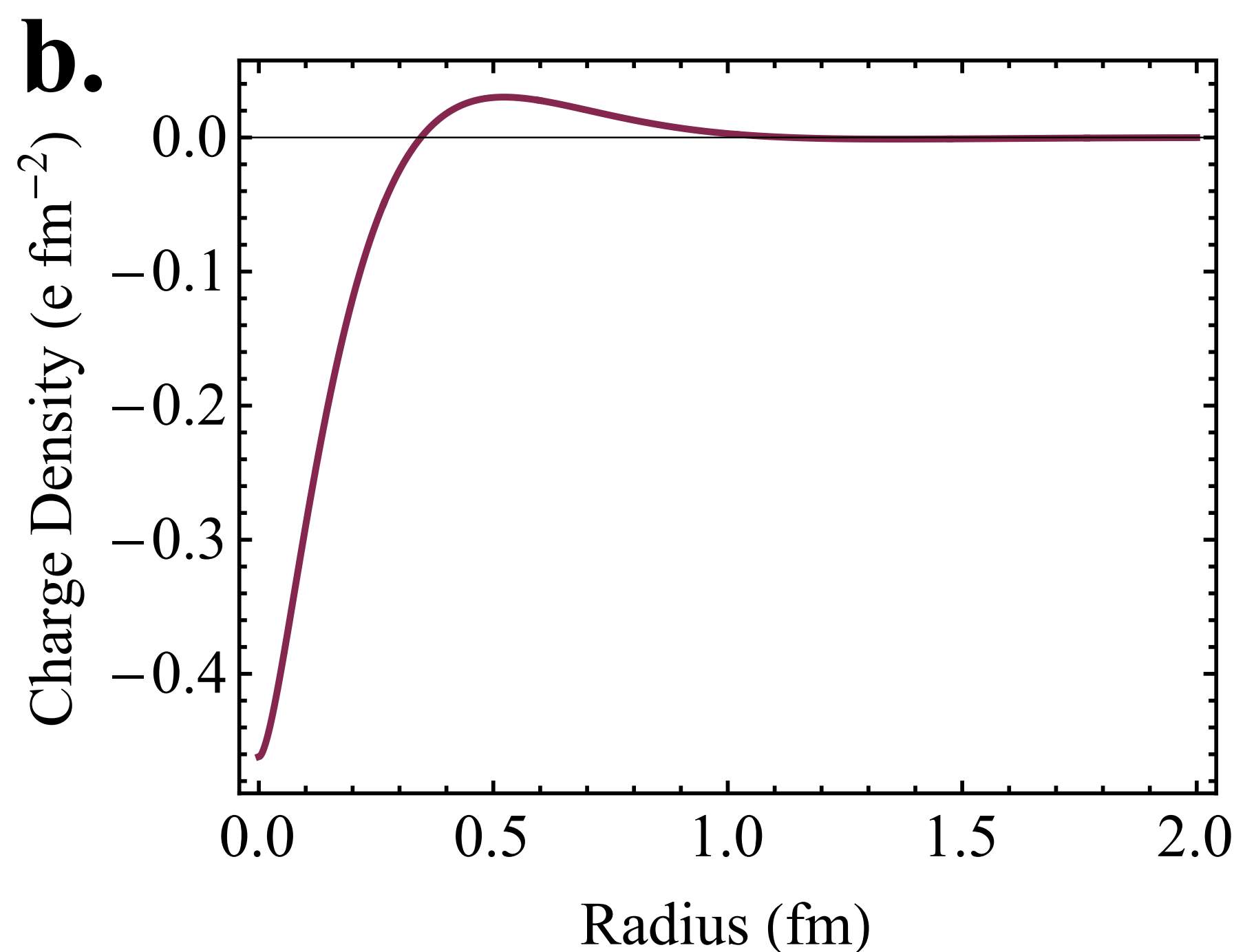
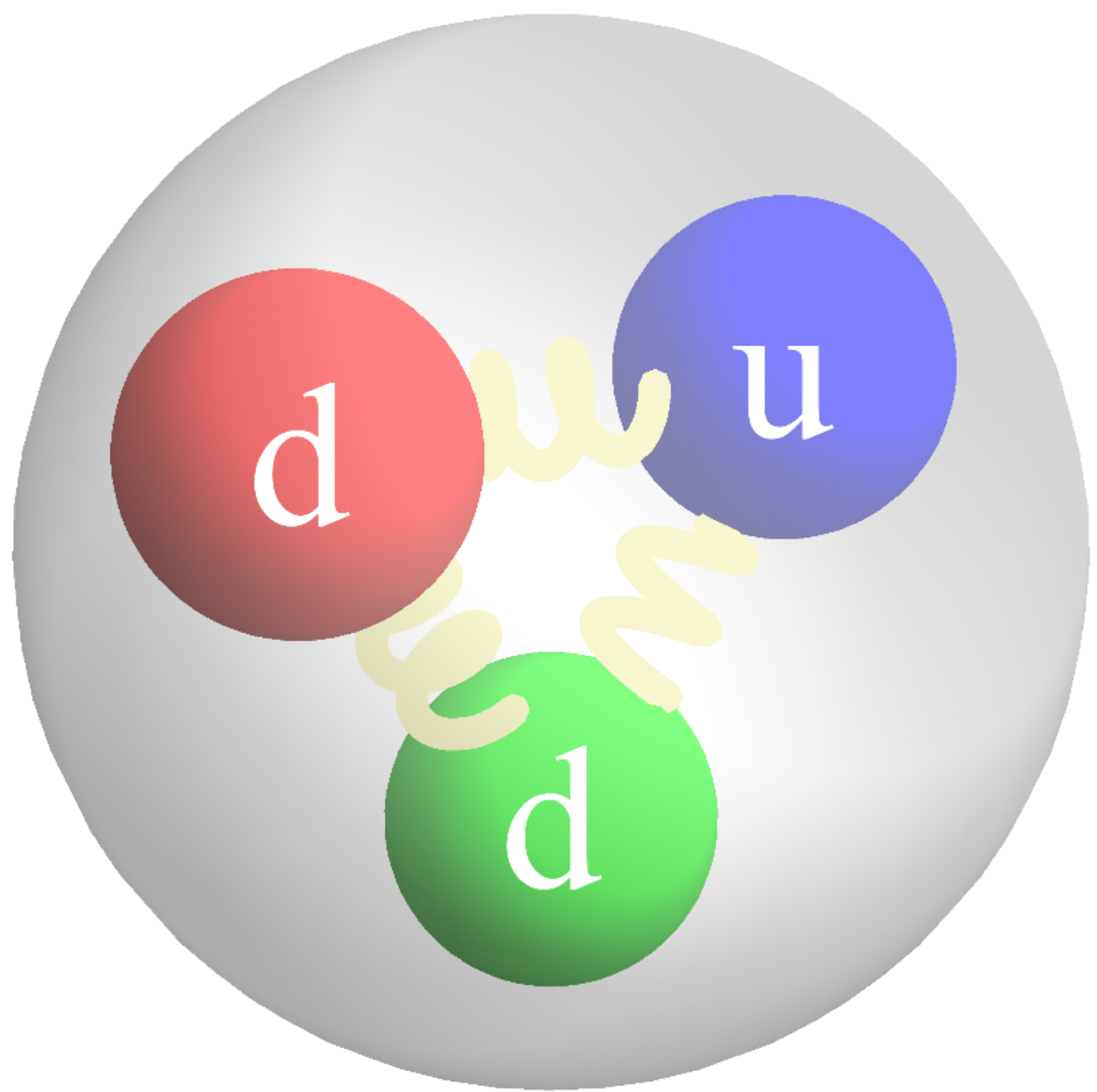

Neutrons

$$\rho(r) = \frac{1}{2\pi} \int_0^\infty q dq \left(\frac{4m_n G_E(q^2) + q^2 G_M(q^2)}{4m_n + q^2} \right) J_0(qr)$$

Form Factors

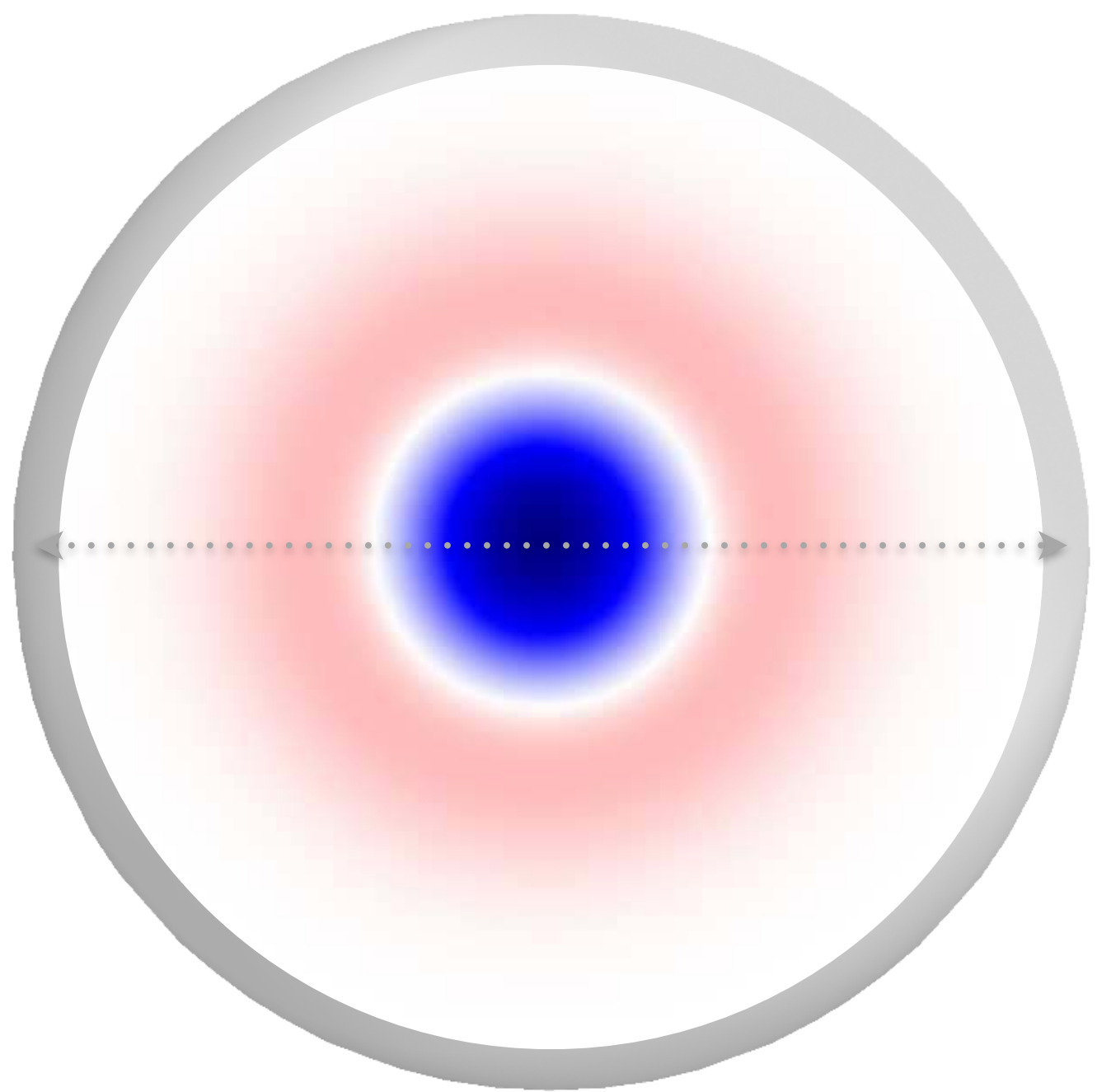

2 fm

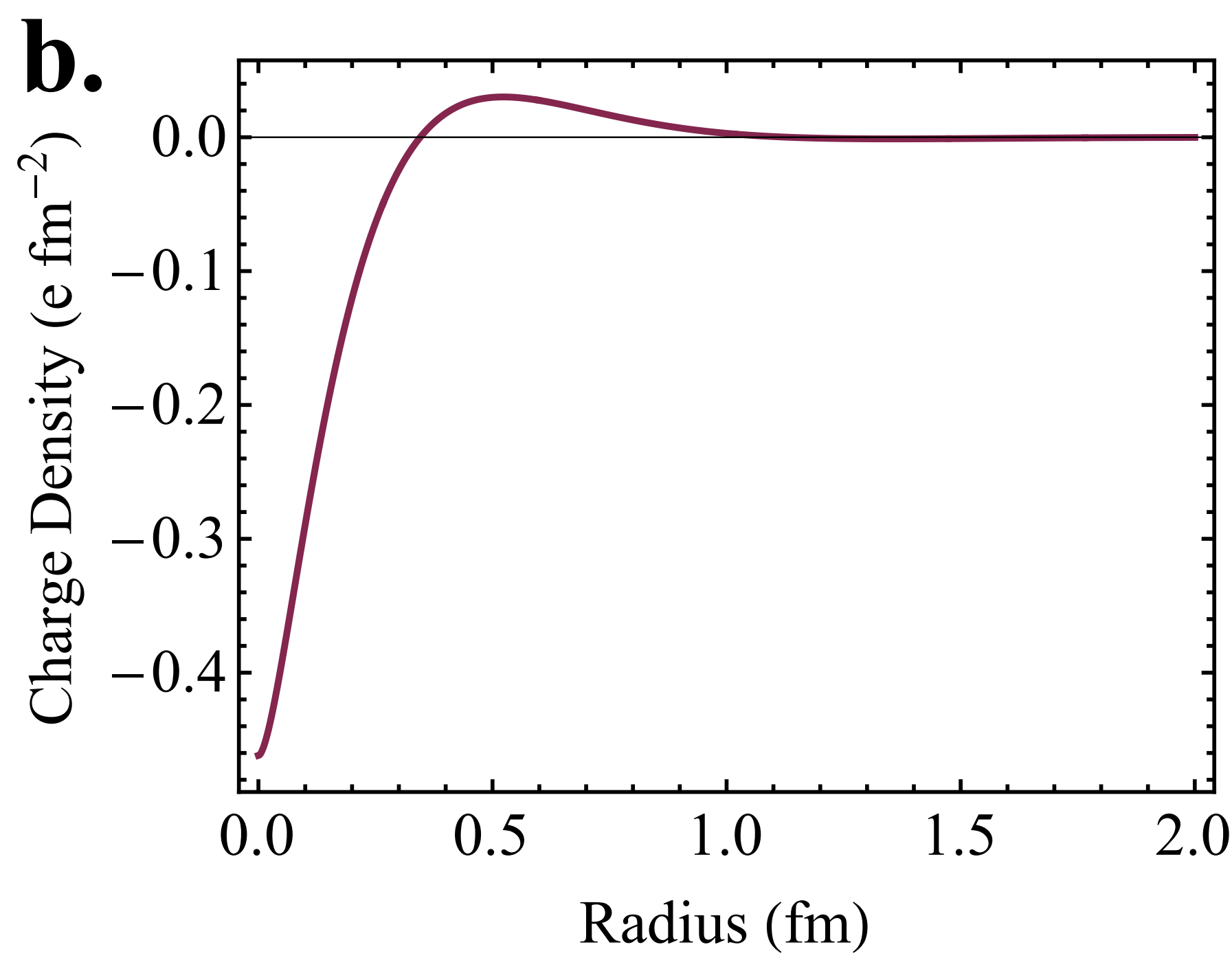

Twisted Neutrons

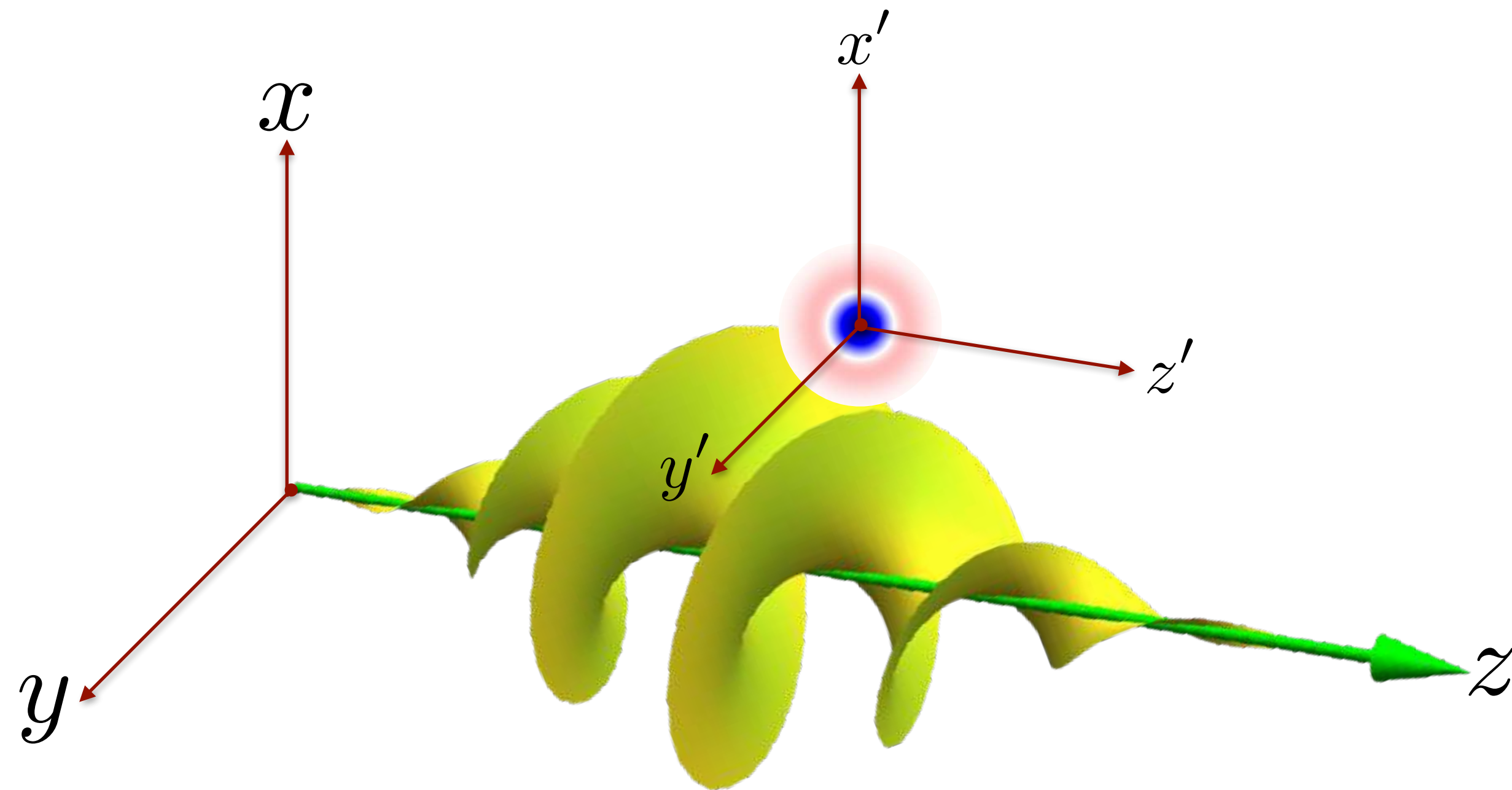

Twisted Neutrons

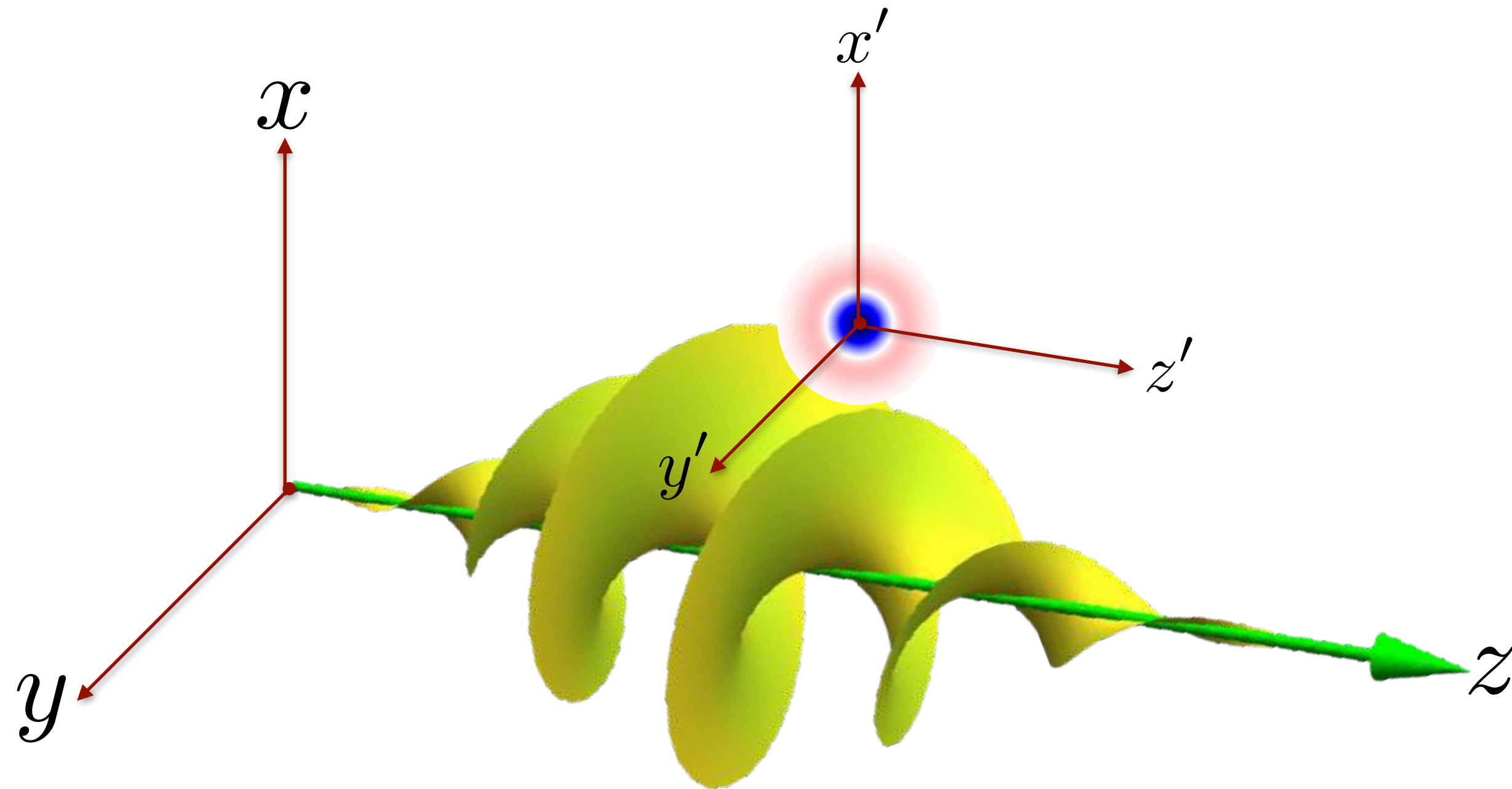

$$\rho_\ell(\mathbf{r}) = \int \rho(\mathbf{r}' - \mathbf{r}) |\psi_\ell(\mathbf{r}')|^2 d^3\mathbf{r}'$$

$$\mathbf{J}_\ell(\mathbf{r}) = \int \rho(\mathbf{r}' - \mathbf{r}) \mathbf{j}_\ell(\mathbf{r}') d^3\mathbf{r}'$$

Twisted Neutrons

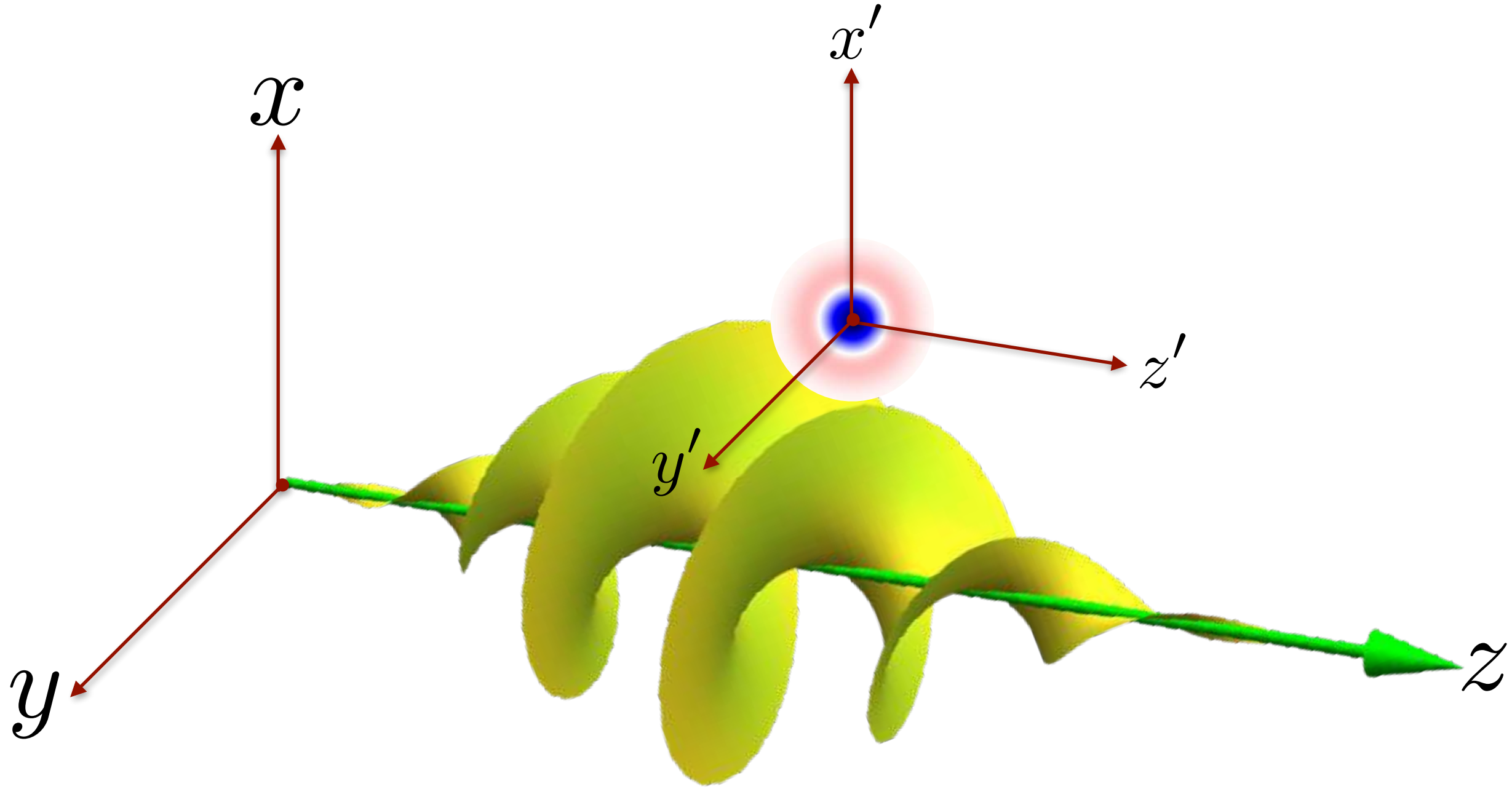

$$\rho_\ell(\mathbf{r}) = \int \rho(\mathbf{r}' - \mathbf{r}) |\psi_\ell(\mathbf{r}')|^2 d^3\mathbf{r}'$$

$$\mathbf{J}_\ell(\mathbf{r}) = \int \rho(\mathbf{r}' - \mathbf{r}) \mathbf{j}_\ell(\mathbf{r}') d^3\mathbf{r}'$$

$$\rho_\ell(\mathbf{r}) = \frac{2}{\pi} \frac{\sigma^{2|\ell|}}{(w^2 + \sigma^2)^{|\ell|+1}} \exp\left(-\frac{2r^2}{\sigma^2}\right) {}_1F_1\left(|\ell| + 1; 1; \frac{2r^2 w^2}{\sigma^2(w^2 + \sigma^2)}\right)$$

$$\mathbf{J}_\ell(\mathbf{r}) = \frac{\hbar \ell}{m_N} \frac{2\sqrt{2}}{\pi w} \frac{\Gamma(|\ell| + \frac{1}{2})}{\Gamma(|\ell| + 1)} \frac{(\sigma^2)^{|\ell|-1/2}}{(w^2 + \sigma^2)^{|\ell|+1/2}} \exp\left(-\frac{2r^2}{\sigma^2}\right) {}_1F_1\left(|\ell| + \frac{1}{2}; 1; \frac{2r^2 w^2}{\sigma^2(w^2 + \sigma^2)}\right) \mathbf{e}_\varphi$$



Twisted Neutrons

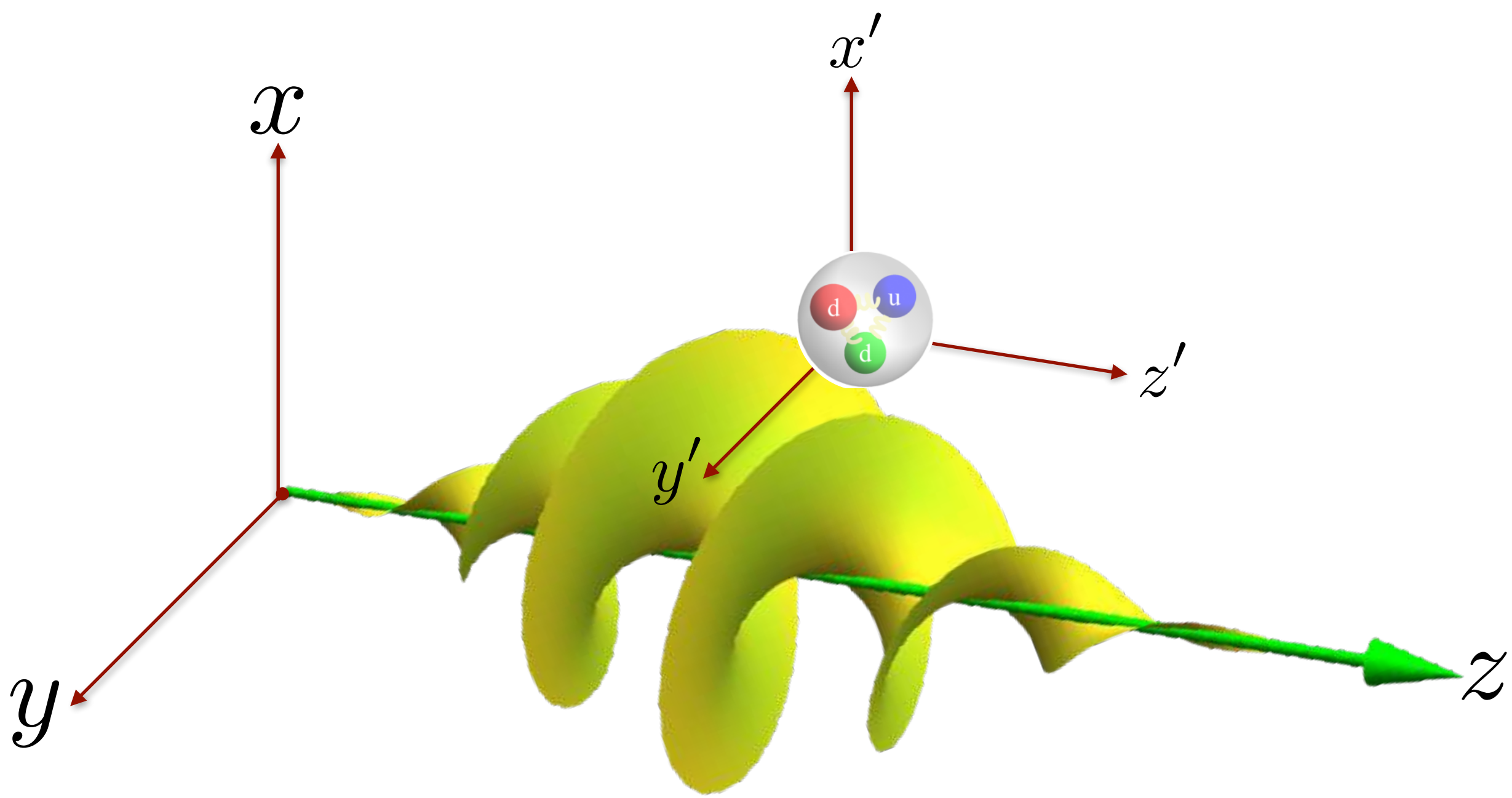

a.

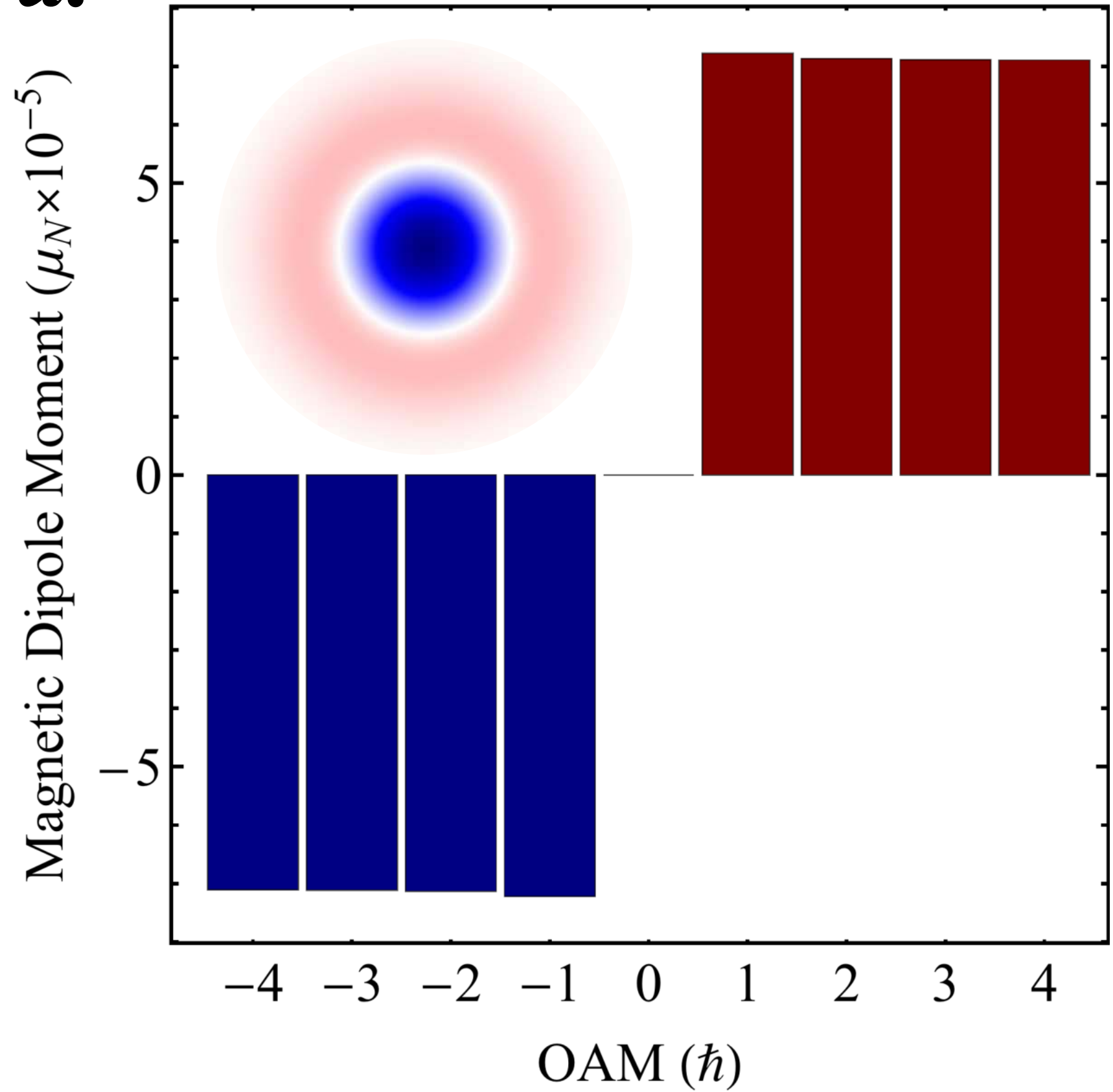

Summary

Fundamental Questions

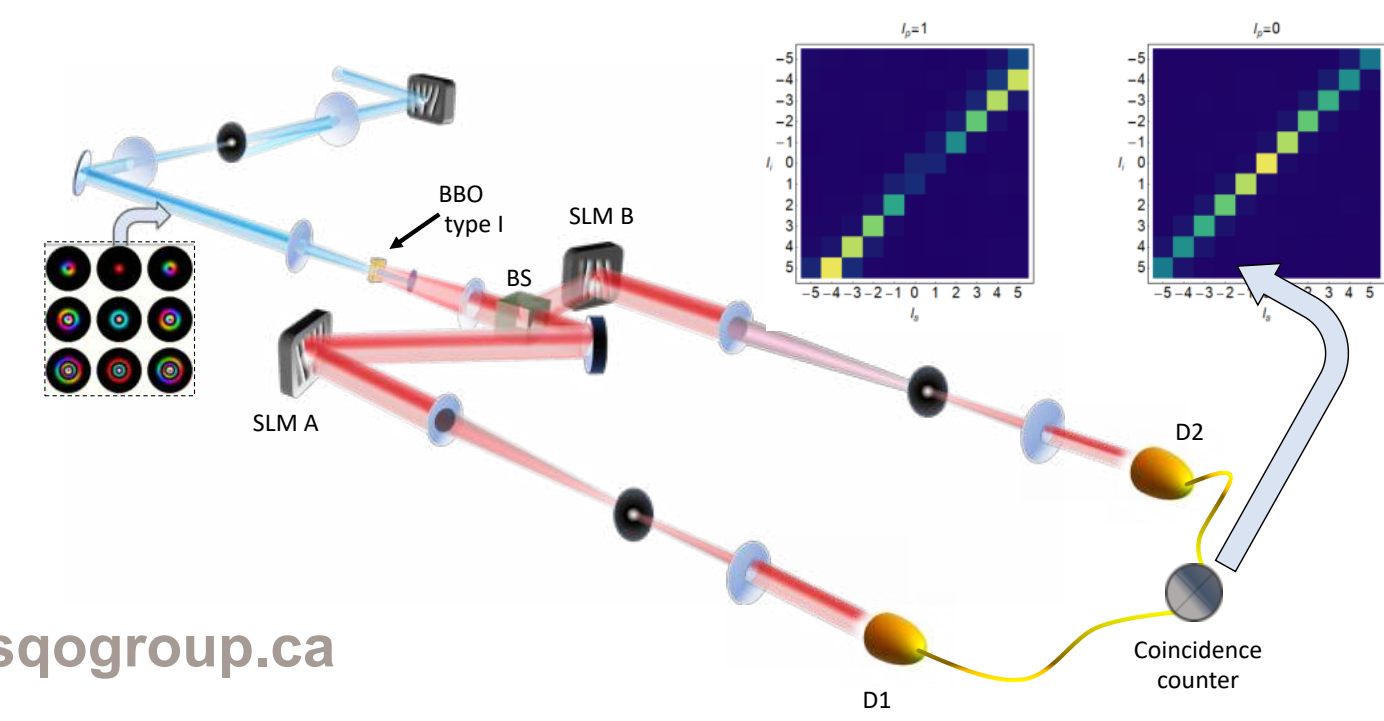
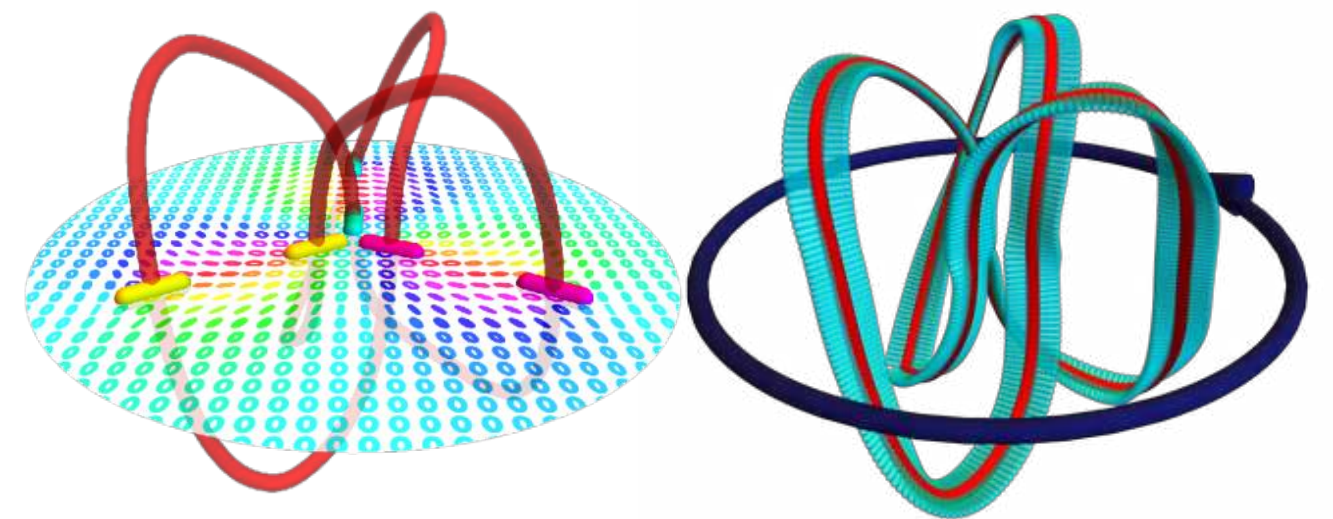

Extreme Quantum Microscope

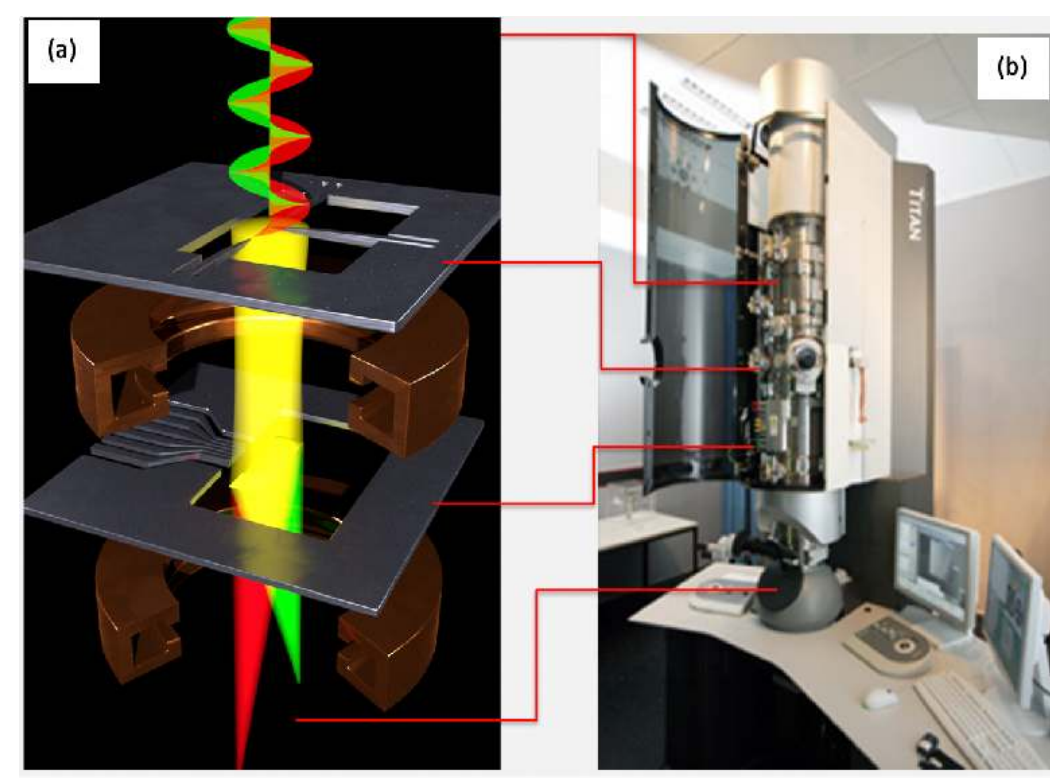
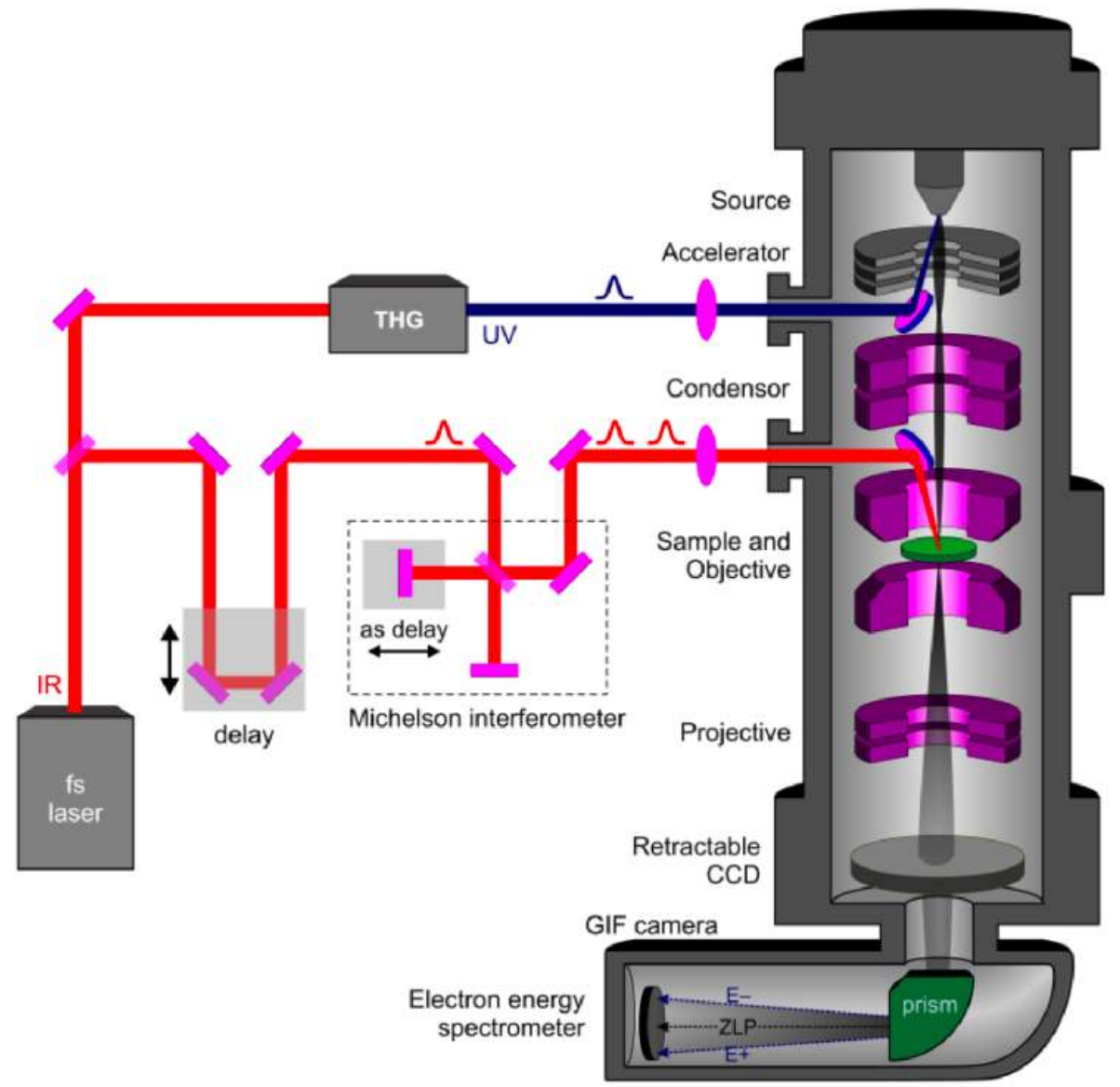

Quantum Internet Canada

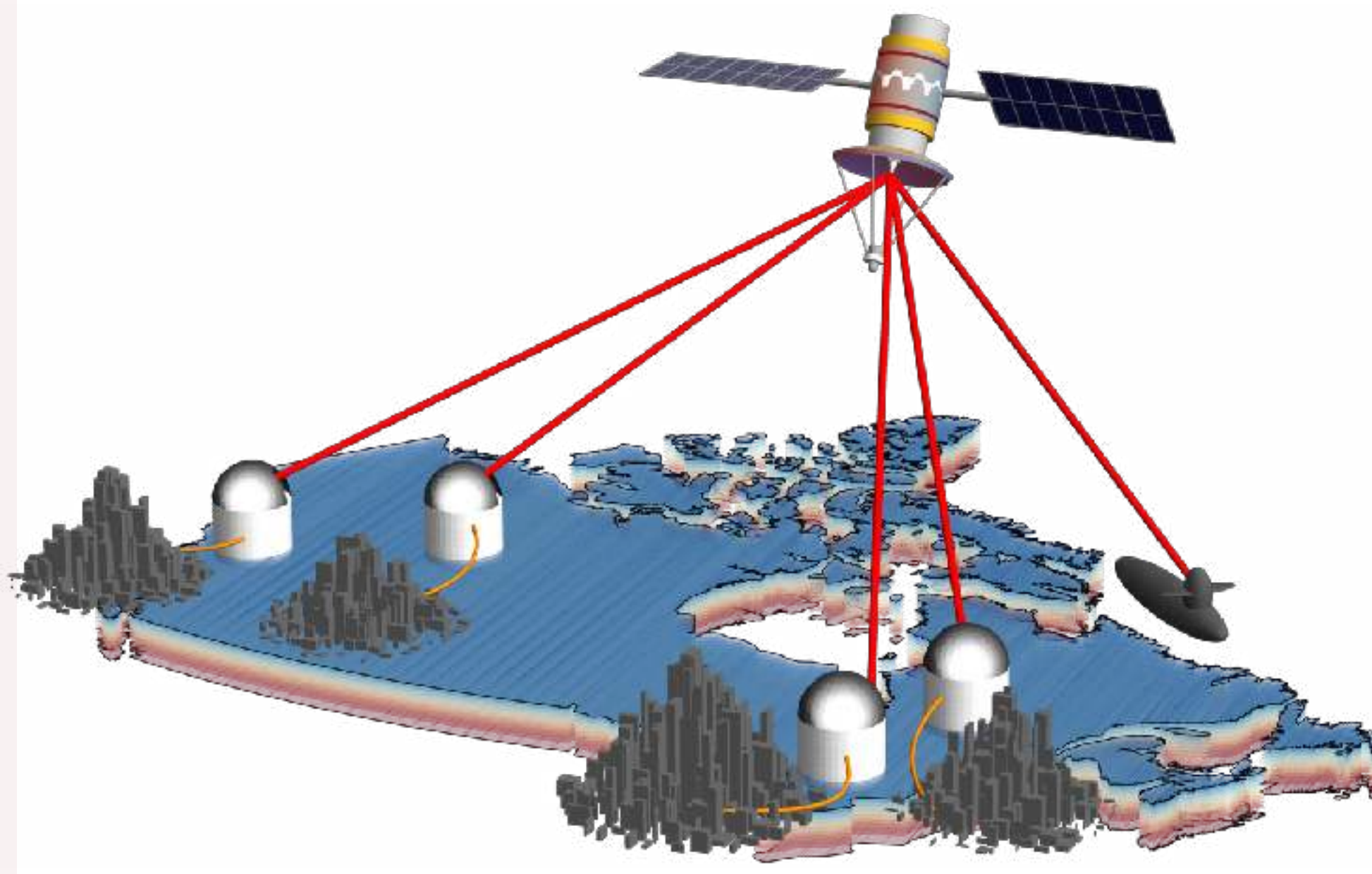

Summary

Fundamental Questions

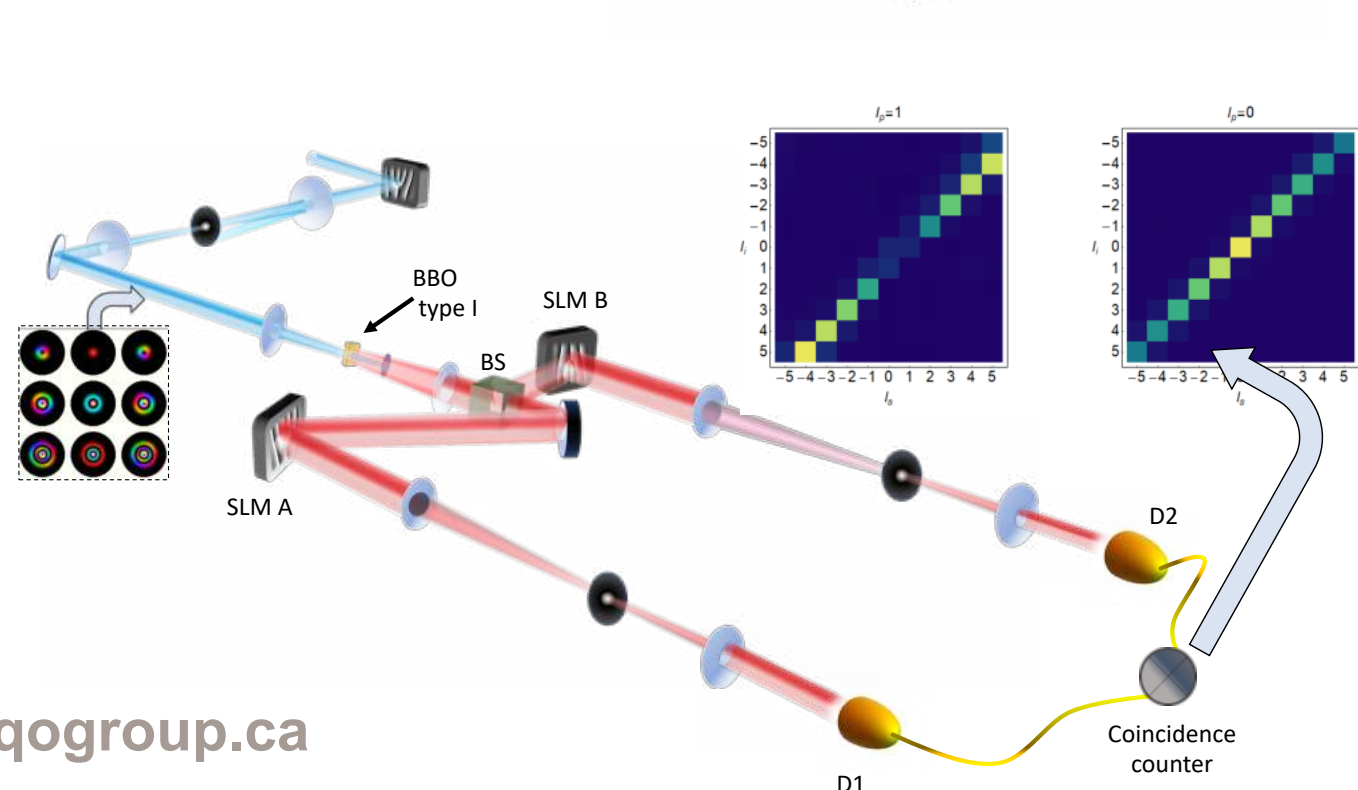
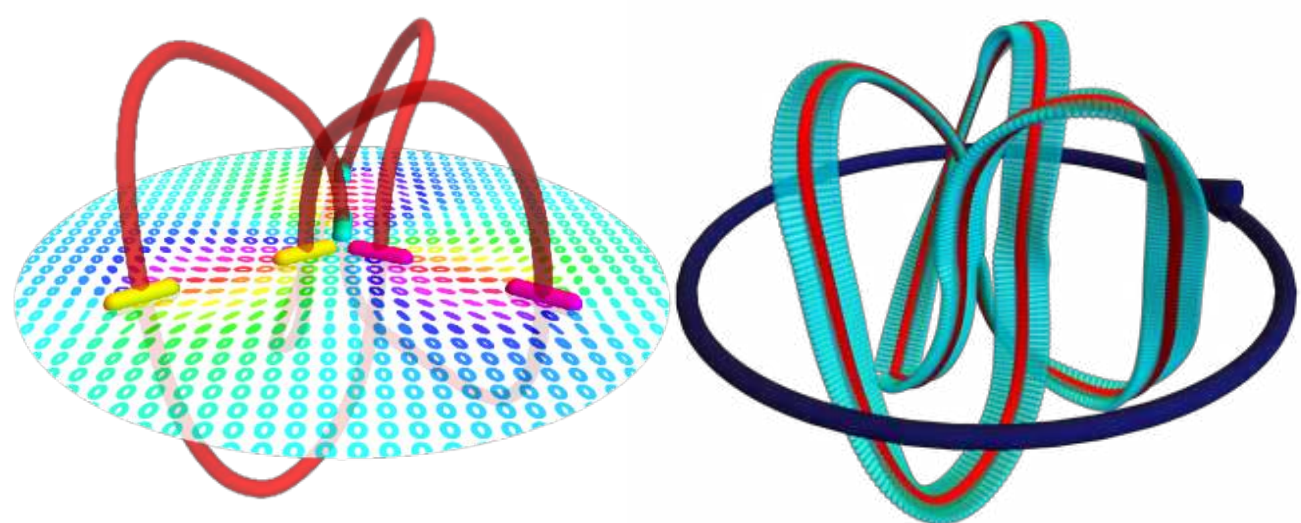
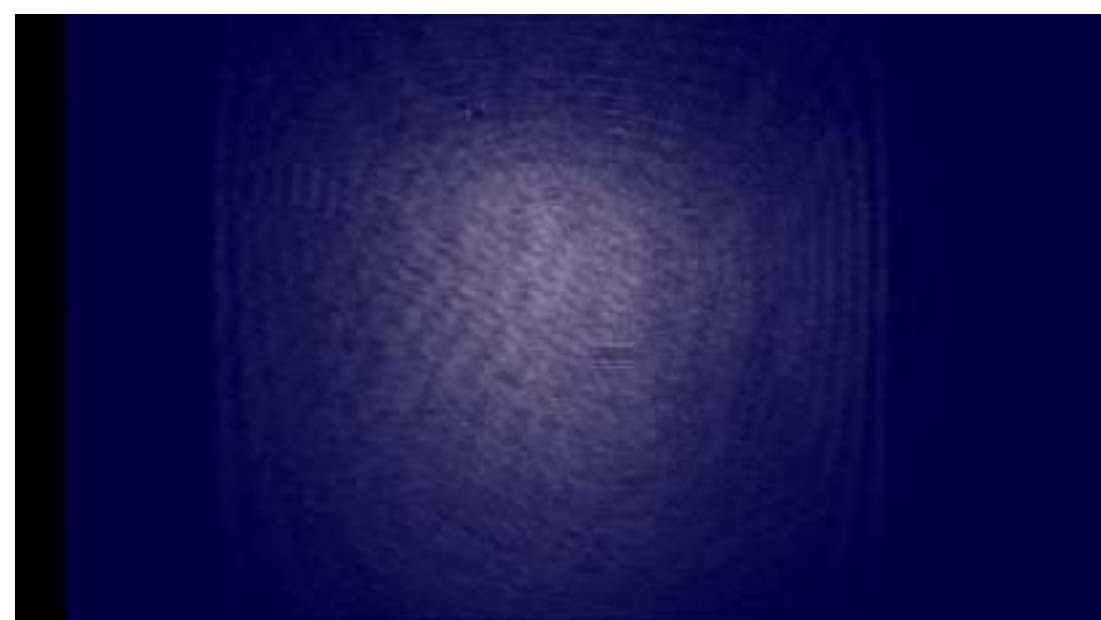

Extreme Quantum Microscope

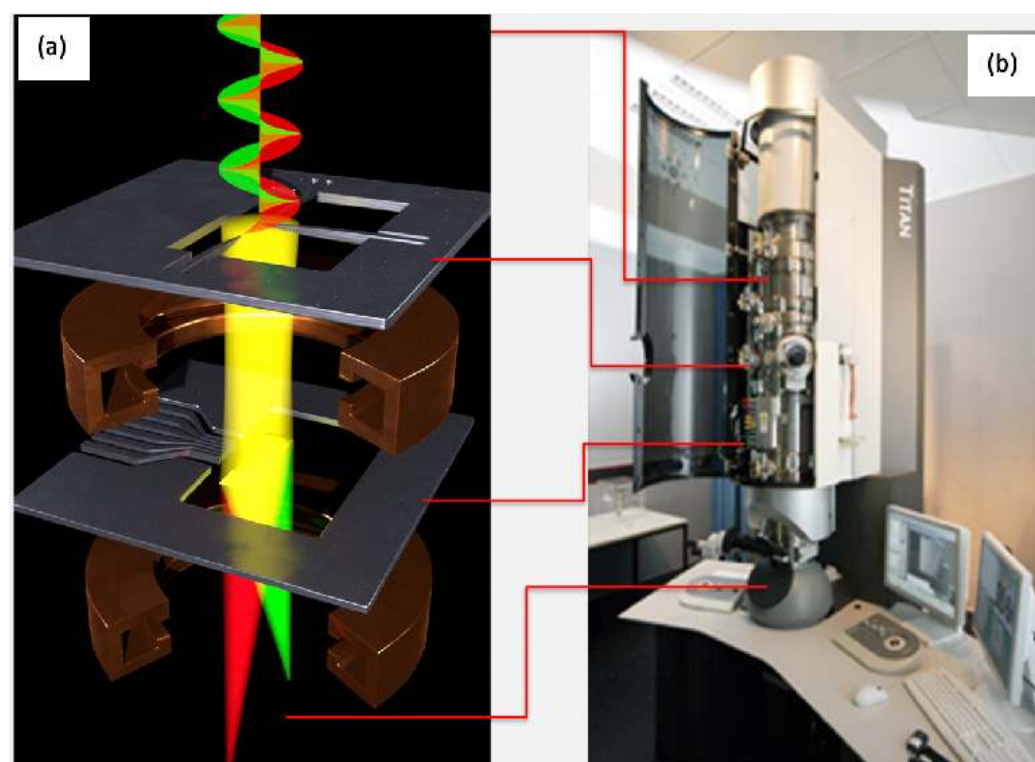
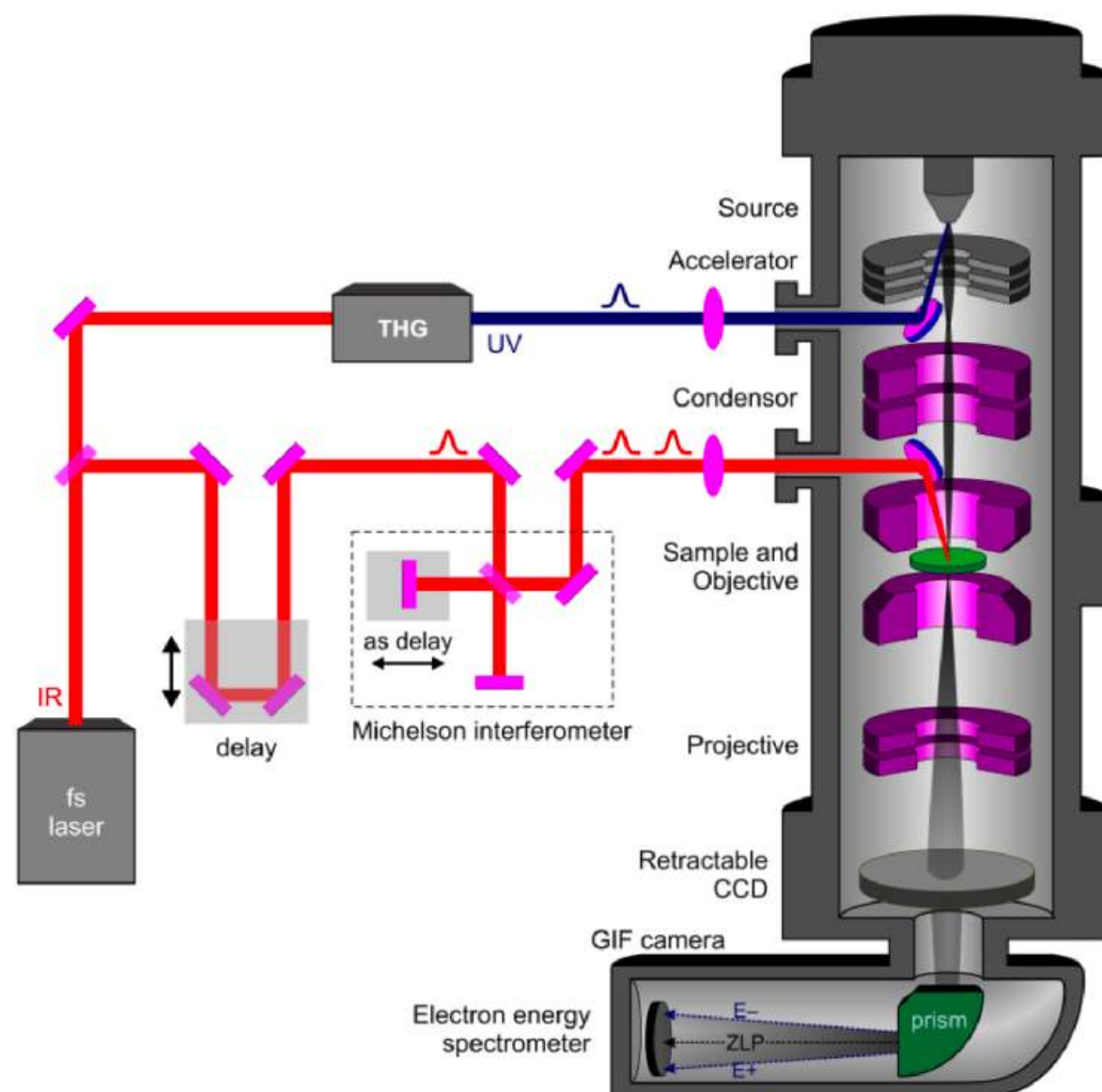

Quantum Internet Canada

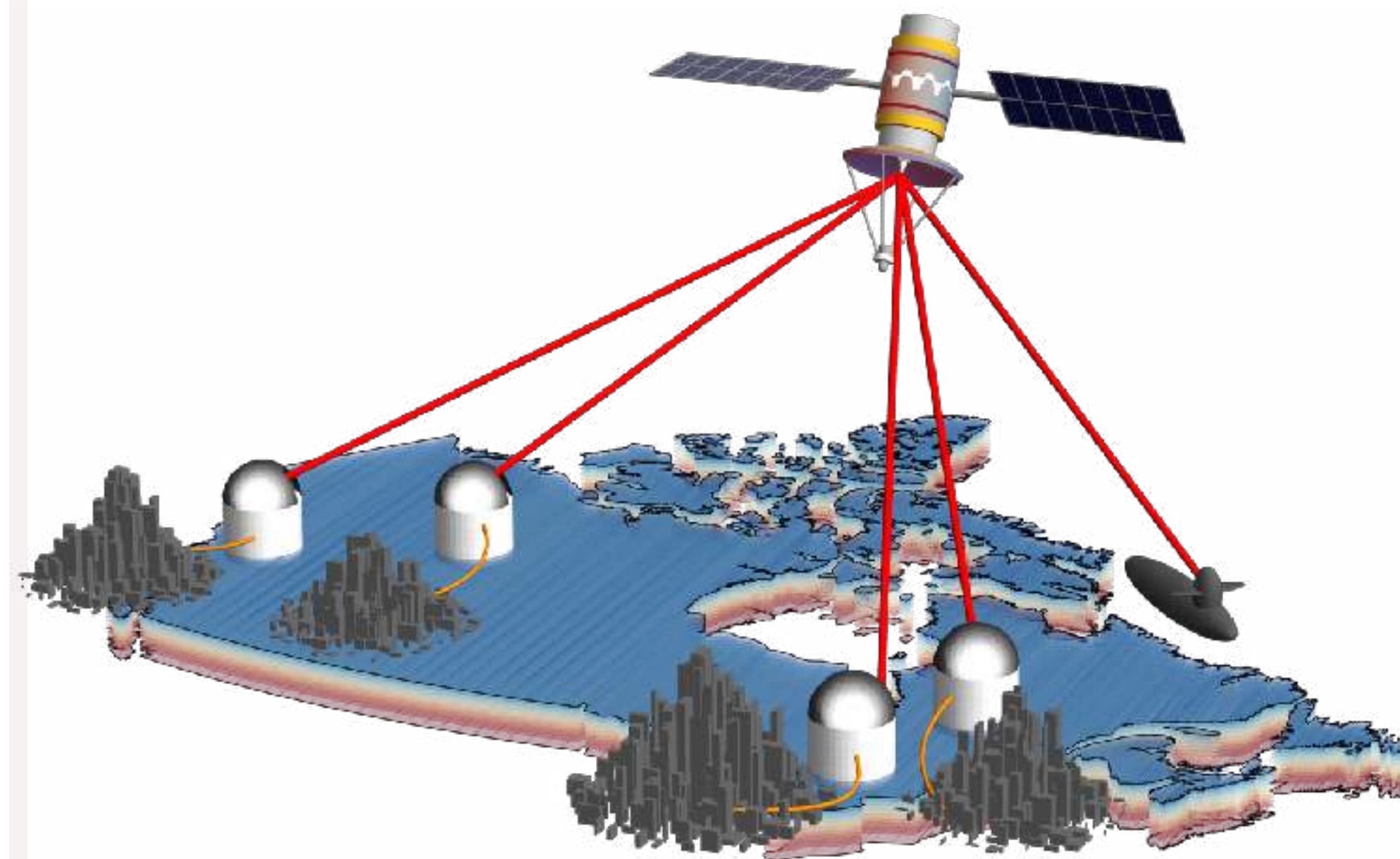



sq team

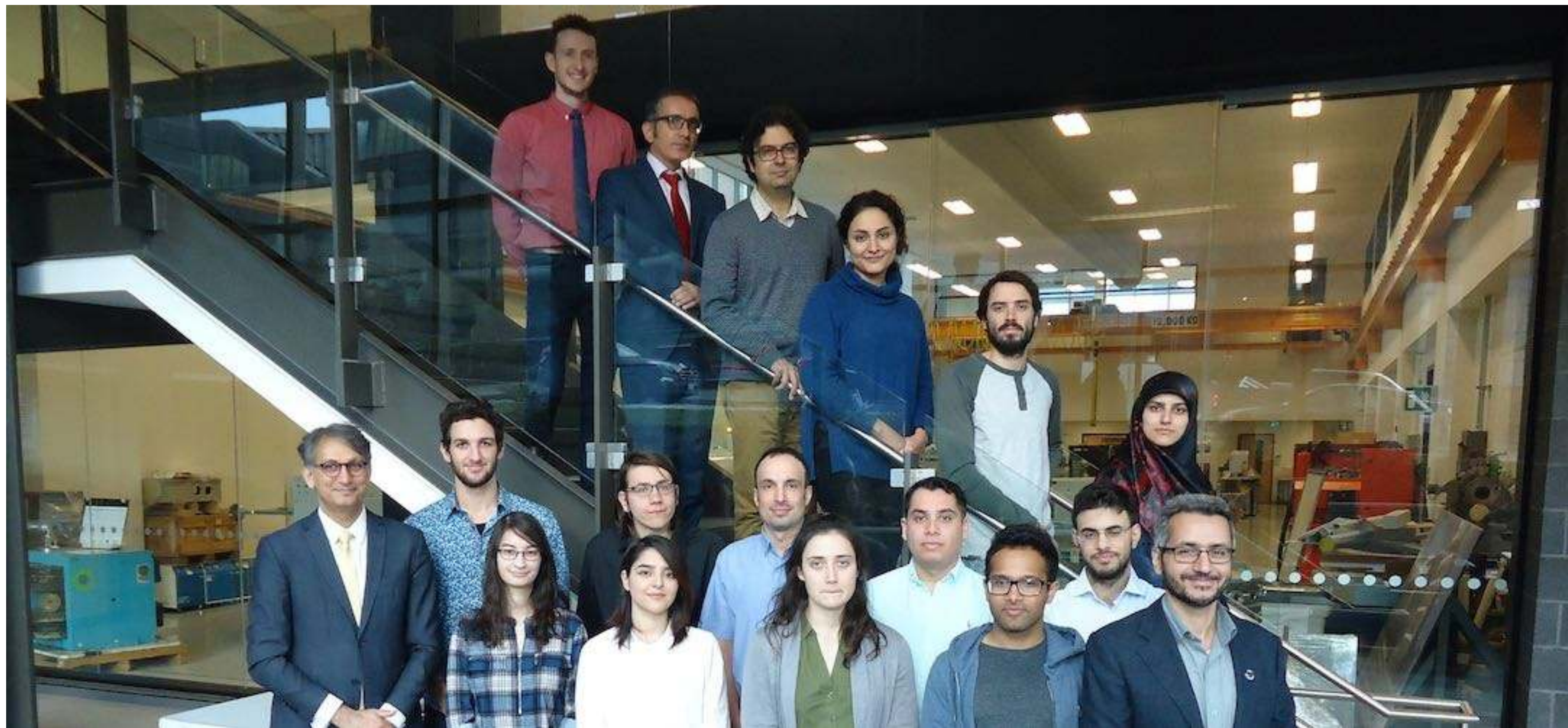

Noah Staudte
Co-op high-school student



Frédéric Bouchard
Researcher - NRC



Dr Robert Fickler
Assistant Prof in Tampere University



Hugo Larocque
PhD student MIT



Dr Yingwen Zhang
Researcher - NRC



Dr Eliahu Cohen
Assistant Prof in Bar Ilan

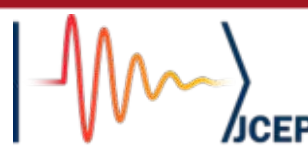

Collaborators



..., and many other members of these research teams





Canada Research Chairs

www.chairs-chaire.gc.ca

uOttawa

INNOVATION.CA

CANADA FOUNDATION FOR INNOVATION

FONDATION CANADIENNE POUR L'INNOVATION



European Commission

Horizon 2020
European Union funding
for Research & Innovation



CANADA FIRST
RESEARCH EXCELLENCE FUND

APOGÉE CANADA
FONDS D'EXCELLENCE EN RECHERCHE



**NSERC
CRSNG**

